

The Physics of Morphogenetic Planetary Resurrection

5 Great Ages of the Maya and the Ancients to initiate a human civilization to graduate into a starhuman universal civilization after 128,134 Years

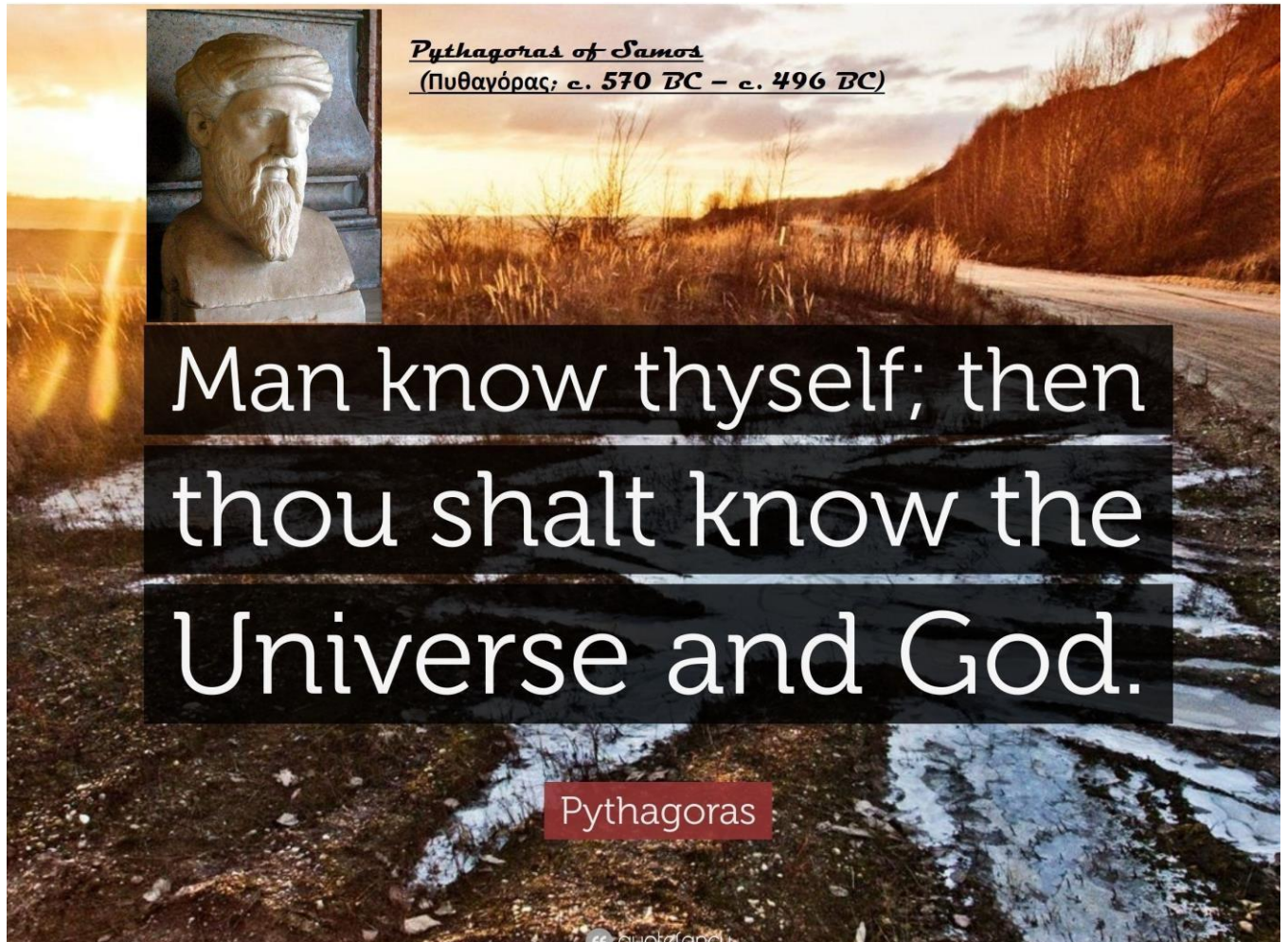

Pythagoras of Samos
(Πυθαγόρας; c. 570 BC – c. 496 BC)

Man know thyself; then
thou shalt know the
Universe and God.

Pythagoras

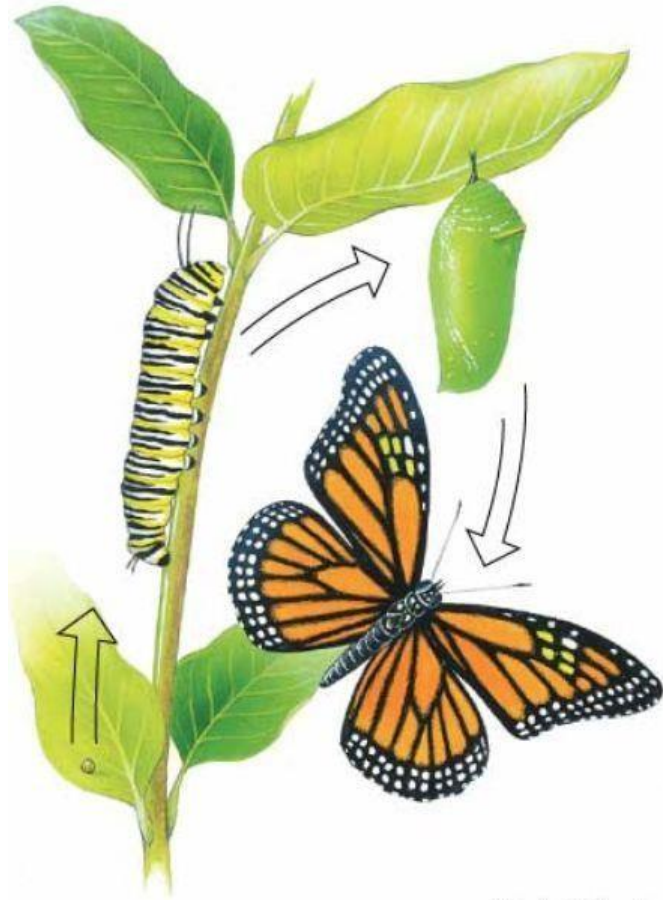

Elizabeth Morales



*René Descartes Latinized: Renatus Cartesius;
31 March 1596 – 11 February 1650)*



**I THINK,
THEREFORE
I AM**

"Mind over Body!" as a Wave About the Particular in Cartesian Separation of the matter-radiation physics as a basis of the cosmogenesis.

"Body Mind' over 'Mind Body!" as a 'Wave of Morphogenetic Individuation' About the 'Body of the Wave contained' in the hybrid of the radiation mass body.



This technical discourse demands no more, than a basic familiarity with Newtonian physics and a basic understanding of algebra and elementary calculus and the foundation of scientific rationalism and application. The basic premises of quantum mechanics and their links to classical physics are however indicated and are extended in some basic postulates addressing the ontological basis of the physical sciences themselves.

The follow-up article on the 'Water science of the Maya' is in correspondence with the technical definitions and derivations given and can be utilized to complement the subject matter addressed in this treatise.

I shall here simply use the detailed results from the following essay to indicate the fundamental Physics of Resonance Source Consciousness required to render the totality soul introduced in the above as a unified cosmic entity who can have its cake and eat it too.

It is this hybridisation between the wave energy state expressed in Planck's Radiation Law for Energy $E=hf$ and the classical mass-Energy Equivalence of Einstein's; $E=mc^2$; which if coupled to the higher energy matrix of the superbranes, allows the creation of a tertiary energy self-state, namely that of a technically defined Radiation-Mass, based on a fundamental particular gauge energy state, the cosmic dragon ET calls the Rest Mass Photon or RMP; which defines and crystallizes the so called 'Body of the Resurrection' as a natural consequence of cosmic evolution and emergence. The resonant 'Eigen Energy States' necessitated for this emergence must however necessarily reflect the basic parameters and constituents responsible for the creation of the universe itself from its prior timeless and space absent plenum of abstract ontology. Those basic abstract entities requiring the presence of neither space nor time to exist as a form eternal or structureless beingness; the cosmic dragon or the Universal Word or Logos calls Abba - the high energy vibratory energy self-state of any soul in toto and as the Creator waveform in

eternal entwinement with Baab, the Creation body form particular and as a complementary winded low energy self-state of the soul, thus defining the nature of a soul heuristically in first principality.

Abba has a frequency and this frequency is the maximum vibration any structured form, body or particle can attain. Abba's frequency so defines the 'Point of singularity', the universe is said to have emerged from in a so called Quantum Big Bang.

Now because Frequency is the ONLY physical quantity, which can be linked to space and time as a Pure Number as Inverse Time; Abba's frequency, defining this human minded construct of 'Love' alone suffices to build and construct a seedling universe containing substructures like galaxies, stars and people, viruses and crystals.

This is because having frequency, say as a repeating oscillation of something else, this something else becomes defined in time and the invariance of the speed of light. Lightspeed is bounded from below by the acceleration limit of inertial objects like particles and is bounded from above by the massless energy state not of mass coupled electromagnetic radiation (which requires the acceleration of Coulombic Electro charges to exist and be created or generated), but by the 'energy world of the souls'. A medieval worldview might call this realm of the 'light bodied souls' heaven or nirvana or paradise of Etheria or even mathimatia as the abstract world of Abba, but not Baab.

Only using the existence of the Energy states of the soul and defining and transmuting this beingness from one form of energy into another suffices to enable definition of other fundamental physical units of description and measurement. This becomes a consequence of such concepts of speed and velocity being distance per time travelled and Energy itself being work done and Action being momentum times displacement or energy times time, then using the basic definitions of mass and displacement and time and temperature, Overall there are seven basic physical units which allow a physical universe as Abba's to be constructed with geometric supplements based on transcendental fundamental constants such as Pi in the Steradian and the Natural Logarithm; (Displacement; Time; Mass; Temperature; Molarity; Electric Charge and Luminosity) are those units.

But Abba's Number suffices to define the Wormhole Singularity as a basic building unit for the cosmos, because the Quantum Law of Planck $E=hf_{Abba} = 3 \text{ Thousand Million Billion Trillion Vibrations times Planck's Constant}$ to give Abba's quantum energy as 1/500 Units of Energy, called Joules.

So knowing this number; Abba's wormhole in the world of the light body soul also becomes defined in the world of the physicalized soul in $E=mc^2$. It calculates as 2.222×10^{-20} kg for the constant lightspeed across the dimensions of 300,000 km per second.

Now Baab also has a frequency and as Baab is interwoven and quantum entangled with Abba across all possible worlds and spacetimes and time spaces; the product of their numbers must be unity or 1. And so Baab's number or frequency is the upside down or inverse of Abba's Number as 3.33×10^{31} Hertz or cycles per second.

In medieval times, Baab's number was also known as the Devil's Number or the Creation Frequency and Abba's number was termed God's Number of the Creation. Well the dragons and extraterrestrial watchers know about those numbers, as their Omni-physics depends on a proper and sufficient understanding of the mechanics of universe creation. And as the humans could not understand the wave mechanics in their medieval histories, the humans created many other names and labels for the duality state of energy of the souls.

This duality can also be said to be at the center of the mind-body conflict or paradox, which has engaged many human philosophers throughout the history of the human genotype living on the planet Earth, also known as Gaia Serpentina by the extraterrestrial dragons.

The difficulty of actually measuring and finding this mind as relative to a well-known and measurable location of the human body, has many philosophers and scientists induced to associate the mind with a wave and the body particular with the individuation, say a particular atom or molecule or more complex body form agglomeration.

As the soul must choose to either collapse its wavefunction of nonlocality specific to enter the individuation morph at its Cosmic Birth into Humanity Or to collapse its particular body function at its Cosmic rebirth as a death of its individuation, but return into its wave state; it so also must choose between being mind-focused or centred or being body focused or centred.

Now if the original creation could however be somehow doubled with the Creator not necessarily having to separate or split from its Creation in the Abba-Baab dichotomy; then if Abba somehow could be AbbaBaab and Baab could corollary become transformed into a BaabAbba; then the Mind-Body or Wave-Particle dilemma would become a MindBody-BodyMind or a Wavicle-Partiwave dilemma.

Then the Creator would transform into a Creator Creation and the Creation would become a Creation Creator with consequences from the abstract heaven of the Mathimatia into the many worlds within worlds and rendering the maleness a heShe and rendering the femaleness a Sheheness across many specifications and distinctions made in a nonunified self-state of the gender definitions and as found in the genetics of the sexual chromosomes of the cosmic library of lifeform classifications.

But Abba 'split' from Baab in the Mathimatia for the purpose to create the original dichotomy, which can also be called the 'Breaking of a Supersymmetry' inherent in the primordial wormhole of the Quantum of Spacetime.

But this spacetime can be multi-dimensional and so whilst the basic scale or quantum of Abba's wormhole remains the cosmic building block for all dimensions, 'higher' or interwoven dimensions can define 'extra spacetime' and time spaces for some lower dimensional physics to coexist with some higher dimensional physics, the latter is called omni-physics by the starhuman dragons.

And so the soul in physicality actually carries a potential from the other side of its energy expression, namely that of the light body soul as a shadow.

And so the Body focused soul in existential crisis with its own mind encompassing its body in a form of ethereal self-expression; nevertheless can, if it becomes Self-aware sufficiently in its focus

on the body form; realize its waveform without having to leave its body in a physical dying to its beingness.

In other words, the incarnated soul has not just a Mind ethereal or spiritual and a Body practical; but has a Mind with a shadow or mirrored Body within and hidden by the mind and it also has a shadow mind hidden or obscured within and by its body form or morph.

The trouble for the soul to self-realize itself and to gain cosmic understanding and wisdom so relates in a most intricate and intimate fashion to how well the soul can perceive itself as a cosmic entity, which experiences itself in space and in time for a purpose of collecting information for its library and a record keeping, which adds to a cosmic record keeping of all souls within their collective living as ambassadors for the Mathimatia of AbbaBaab becoming.

Defining the Abba Quantum in physicality as the 'Cosmic Father of All That Is' will naturally also define the Baab Quantum of the 'Cosmic Mother of All That Is' because of their quantum entanglement across all definitions and structures of space and time and the physical dynamics they may contain as a universal background matrix for those events and occurrences.

And so the abstraction and relative unreality of Abba becomes real relative to the physical nature of Baab and made manifest in their numbers of the reciprocal harmony and unification.

The following excerpt from the technical discourse following is here reproduced to serve for the cohesive derivation of the Physics of Morphogenetic Resurrection. The formulations are stated as a background data to allow for simple substitution of basic values for the human body form, often labeled as Merkabah and relating to the 'Cosmic Man' of the 'perennial philosophy', as say illustrated by the Vitruvian Man of Leonardo da Vinci around 1490.



**I can doubt everything, except one thing,
and that is the very fact that I doubt.
Simply put – I think, therefore I am.**

René Descartes

It should be noted, that the technical description of the 11-dimensional supermembrane $E_{ps}E_{ss}$ describes the two parts of any soul in the $\mathbf{E}(\text{nergy})_{\text{primary sourcesink}}$ being Abba and $\mathbf{E}(\text{nergy})_{\text{secondary sinksource}}$ being Baab. So instead of reading $E_{ps}E_{ss}$, the peruser can substitute AbbaBaab for convenient simplicity.

Coulomb Charge $e = L_P \cdot \sqrt{\alpha \cdot c^2} \leftrightarrow 2R_e \cdot c^2 = e^*$ (Star Coulomb Charge)

But the Star Coulomb is Inverse Energy by definition of the vibratory part of the modular dual heterotic supermembrane $HE(8x8)=E_{ps}E_{ss}$.

$E_{ps}=hf_{ps}=hc/\lambda_{ps}=(m_e/2e) \cdot \sqrt{[2\pi G_o/\alpha hc]}=m_e/\{2e \cdot m_P \sqrt{\alpha}\}=1/e^*$.

m_P is the Planck-Mass and G_o is the initiatory Gravitational Constant, defined in the Fine Structure-Relation, which defines the Planck-Length-Oscillation in the unification of electromagnetic interactions with those of gravitational permittivity: $G_o=4\pi\epsilon_o=1/30c$ with dimensionless c-ether constant [c]unified.

As Quantum Relativity is defined in the charge mappings between the Omni Space dimensions; F maps magneto charges e^* onto electro charges e under agency of the 11D-Witten Mirror, which is a One sided Surface möbian connecting 10D to 12D.

The all-encompassing source energy quantum is the E_{ps} -Gauge Boson, which manifests as the Gauge mediator for the four elemental interactions, suppressing the weak interaction in a primary triplicity however to allow the Higgs Restmass Induction mechanism to proceed in the defining qualities of the Unified Field of Quantum Relativity (UFoQR).

$1/E_{ps}=e^*=2R_e c^2=\sqrt{\{4\alpha h c e^2/2\pi G_o m_e^2\}}=2e\sqrt{\alpha[m_P/m_e]}=2ke^2/m_e=\alpha hc/\pi m_e$

Here e^* is defined as the inverse of the sourcesink vibratory superstring energy quantum $E_{ps}=E^*$ and becomes a **New Physical Measurement Unit** in the **Star Coulomb (C^*)** and as the physical measurement unit for 'Physical Consciousness'. R_e is the 'classical electron radius' coupling the 'point electron' of Quantum- Electro-Dynamics (QED) to Quantum Field Theory (QFT) and given in the electric potential energy of Coulomb's Law in: $m_e c^2=ke^2/R_e$ and for the electronic rest mass m_e . Alpha α is the electromagnetic finestructure coupling constant $\alpha=2\pi ke^2/hc$ for the electric charge quantum e , Planck's constant h and lightspeed constant c and G_o as the Newtonian gravitational constant as applicable in the Planck-Mass $m_P=\sqrt{(hc/2\pi G_o)}$.

$e^*=\text{VolumexAwareness}=\text{Electron Field Diameter} \times df/dt=500 C^*$ as the boundary condition for $df/dt=f^{*2}$ for a Volume $2R_e \cdot L_{\text{min}}^2$.

It is the 'mapping' between the higher and lower dimensional worlds, which is described by the label of magneto charges in the world of the light body soul becoming electro charges in the world of the physicalized embodied soul.

This can be described rigorously in the physics of Black Holes relating to their energy contained within their so termed 'event horizons' and without in a synthesis of Black Hole physics with their 'quantum entangled' (non)locality descriptors as a foundation of quantum wave mechanics. It shall suffice here to illustrate the dimensional boundary between those worlds of the soul as the actual surface of a 5-dimensional universe and cosmology (of 4 space dimensions with one time dimension) allowing the distinction of an Outside and an Inside to be made.

Gaia - Womb of Wombs in the Cosmic Ovum of Creation

A Terrestrial Mother of All Life That Is Extraterrestrial

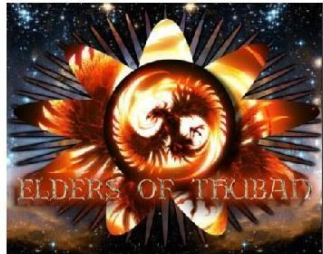
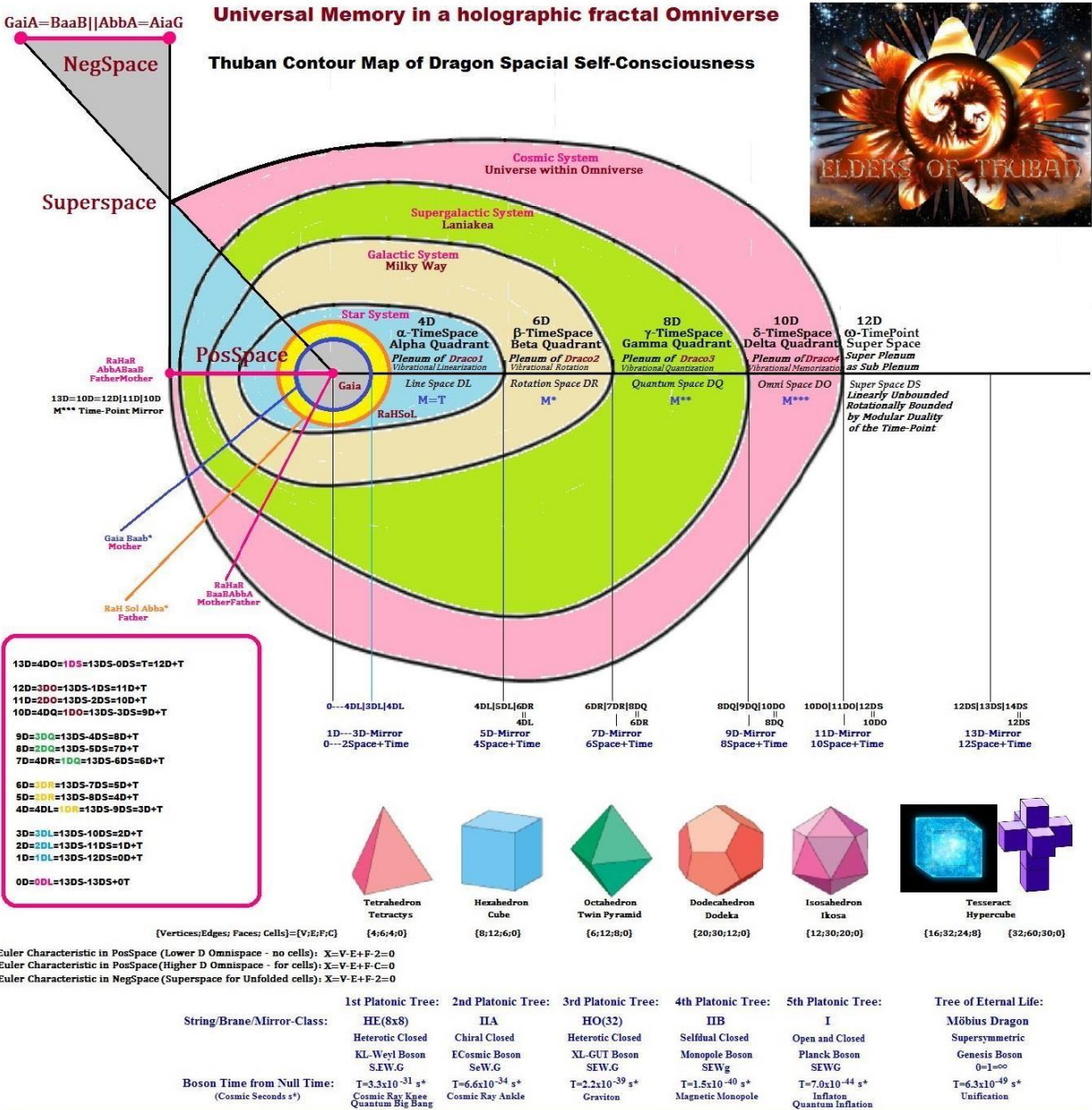

Gospel of Thomas - Lambdin:

(19) Jesus said, "Blessed is he who came into being before he came into being. If you become my disciples and listen to my words, these stones will minister to you. For there are five trees for you in Paradise which remain undisturbed summer and winter and whose leaves do not fall. Whoever becomes acquainted with them will not experience death."

	S.E.W.G	SeW.G	SEW.G	SEWg	SEWG	0=1=∞
Boson Time from Null Time: (Cosmic Seconds s*)	T=3.3x10 ⁻³¹ s*	T=6.6x10 ⁻³⁴ s*	T=2.2x10 ⁻³⁹ s*	T=1.5x10 ⁻⁴⁰ s*	T=7.0x10 ⁻⁴⁴ s*	T=6.3x10 ⁻⁴⁹ s*
	Cosmic Ray; Kgee Quantum Big Bang	Cosmic Ray Ankle	Graviton	Magnetic Monopole	Inflaton Quantum Inflation	Unification

Gospel of Thomas - Lambdin:
 (19) Jesus said, "Blessed is he who came into being before he came into being. If you become my disciples and listen to my words, these stones will minister to you. For there are five trees for you in Paradise which remain undisturbed summer and winter and whose leaves do not fall. Whoever becomes acquainted with them will not experience death."





The Null-Zero Point Singularity Dimension at the Center of the Earth hosts the Memory of the Universe, defined in Time and Space. The Volume of the Inner Space of the planetary body of Gaia is separated from its Volume of the Outer Space by its surface or membrane and as a 3-dimensional geometrical topological Inner Mirror of 2D-Line Space (or Area) with 1D-Time.

This dimensional divide is imaged as the Boundary of the Universe within a multidimensional Omniverse and where the Outer Mirror separates the Inner Space of 10 string dimensions from its Outer Space in 12 brane dimensions. The 12th brane dimension recircularizes the lower dimensional nesting of the omniversal ovum and therefore images and recreates the Null-Zero Point Dimension at the centre of Gaia as a Time-Point Singularity of Null Space.

The 10-dimensional Omniverse defined in a space of 10D, therefore utilizes a 11th Time Dimension as a topological mirror-membrane-surface dimension of 'Pointed Time' to image or 'collect' or absorb the spacetime structure inside of itself in a form of space-defined consciousness quanta and as the 'Cosmic Memory' of the timebased history of the Omniversal Evolution. As the 10th string dimensions of in topological Membrane Space is equivalent to the 12th brane dimension in the closure of the plenum continuity; the Singularity at the Core of Gaia as a planetary metaphysical hypergeometric Center WITHIN a timebased cosmology becomes equivalent to the Singularity upon the entire surface or boundary of the Omniverse as the WITHOUT.

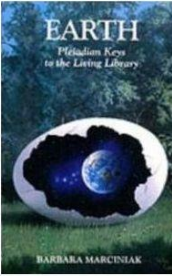
The Time-Point at the Center of the Earth defines the Locus for the generation of the 1st Dimension from the Null Dimension in tracing a Line to manifest the 1-2-3 Volumar of Geometry Space embedded or nested within 10D Omnispace as PosSpace (positive space).

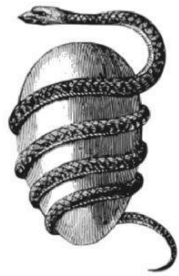
The Time-Point at the Membrane Mirror defines the Locus for the generation of the 12th Dimension from the 11th Dimension in a Time-Point tracing a Super Space Line to manifest a 12-13-14 Supervolumar of supergeometry space. As however, the Time-Point of the Null Dimension is defined in its relative 'negative space' rendering 10D-Omnispace equivalent to 12D-Superspace; this tracing no longer requires dimensional extension into Superspace or NegSpace (negative space). The tracing of Omnispace therefore closes the multidimensional dynamic in the image of the Gaian Core of the Cosmos manifesting the initializing dimension generation in Line Space 0-1-2-3-(4=0=Time) in the generator 10-11-12-(13=4=Time) and rendering the Line Space Time 1-2-3-4 equivalent to the Omni Space Time 10-11-12-13.

Focus Location Library	Director ABBA + JC	Thematic Scenario & Context Communication	Producer BAAB + CJ	Weaver Author Scribe
 <p>00D=Null/Zero-Point Dimension 01D=Line/String Dimension 02D=Area/Membrane Dimension 03D=Volume/Superbrane Dimension 04D=1x3DL+1T=4DLT=Space Time 05D=1x3DL+2T=4DLT+M* 06D=2x3DL+0T=4DLT+2DR 07D=2x3DL+1T=4DLT+3DR 08D=2x3DL+2T=4DLT+3DR+M** 09D=3x3DL+0T=4DLT+3DR+2DQ 10D=3x3DL+1T=4DLT+3DR+3DQ 11D=3x3DL+2T=4DLT+3DR+3DQ+M*** 12D=4x3DL+0T=4DLT+3DR+3DQ+2DS 13D=4x3DL+1T=4DLT+3DR+3DQ+3DS</p>	<p>Executive Playwright = CJJC</p>	 <p>Jurisdiction</p>	 <p>Playwright = JCCJ</p>	 <p>Legislative</p>

The Council of the Elder Dragons from Thuban Shiloh Za-RaH, September 7th, 2014 {7-9-7}

The simplified formulation for the description of physical consciousness is Volume x Angular Acceleration = Higher Dimensional (Magneto Charge) Constant as the Inversion property of E*e* = 1 for the unification of Abba and Baab across the dimensional divide or abyss or 'bottomless pit' or Black Hole.

Angular Acceleration can be expressed as the time differential of frequency as df/dt =awareness aw and so as the square of frequency or the reciprocal of time squared in its boundary condition as Abba's frequency Squared f_{ps}^2 and also as Baab's frequency in its inversion f_{ss}^2 .

The simplified general expression to real physical consciousness to space and time then can be written as the Universal Law of Creator-Creation:

$$\mathbf{ABBAxBAAB = E_{ps}E_{ss} = ACTION^2}$$

$$\mathbf{Volume \times Squared Frequency = Vf^2 = e^* = 1/E^* = 1/E_{ps}=1/hf_{ps} = 1/Abba = Baab/Action^2 = Baab/h^2=f_{ss}/h=E_{ss}/h^2}$$

Should a physicalized soul identify itself solely with its own body, then the space occupied by the soul's body will define the Volume V and so define the consciousness cosmic for that soul.

The volume of a standardized human body morph can be said to be about 70 kg and so about 70 liters as 70,000 cubic centimeters.

Then $V=0.07 \text{ m}^3$ and the characteristic spacetime resonant frequency can be calculated as the square root of e^*/V and as $f_{\text{soul physical}} = \sqrt{(500/0.07)} \sim \sqrt{7142.86} = 84.52$ Hertz and a gamma rhythm neuronal oscillation, which ranges from 25 Hz to 100 Hz, with a typical brainwave pattern of about 40 Hz.

Similarly using Leonardo da Vinci's Vitruvius as a 'Cosmic Man' occupying a 'Bubble Merkabah' of radius 1 meter; Leonardo's soul physicalized will occupy a volume of $4\pi/3$ cubic meters for a cosmic Merkabah frequency of $f_{\text{Cosmic Man soul}} = \sqrt{(500/1)} = 22.36$ Hertz and a typical beta rhythm brain waking state wave frequency.

A proposed unit for a brain based neurological definition for consciousness is based on the Gamma wave brain wave pattern, typified at the 40 Hertz frequency.

This frequency implies a volume of $V=e^*/f^2=500/1600 = 5/16 = 0.3125$ cubic meters for a radius $R_{\text{gamma}} = \sqrt[3]{(15/64\pi)} = 0.421$ meters in a unit sphere Merkabah or a side $s = 0.6786$ meters for a unit cube Merkabah hosting the soul-memory as physicalized consciousness.

For the Dreaming State of Consciousness exhibiting Rapid-Eye-Movement or REM sleep, mirroring the waking state of say the higher neuronal oscillation patterns of the Gamma brain waves; the first Schumann Resonance of 7.83 Hz couples this vibratory planetary self-state as a Mu-wave to the Alpha-wave of the Dreaming state as a shared Planet-Human Merkabah of a volume $V_{\text{human-planet}} = e^*/(7.83)^2 = 8.1554$ cubic meters for a unit-sphere of radius $R_{\text{human-planet}} = 1.2487$ meters and a unit-cube of side $S_{\text{human-planet}} = 2.0129$ meters and the characteristic size of a human upon planet Earth, sharing the basic Schumann frequency of Earth as a characteristic REM sleep alpha wave brain pattern in a mean of $1/2(1.2487+2.0129) = 1.631$ meters.

This calculation so 'squares the circle' and cubes the sphere in the labels of the morphogenetic resonances.

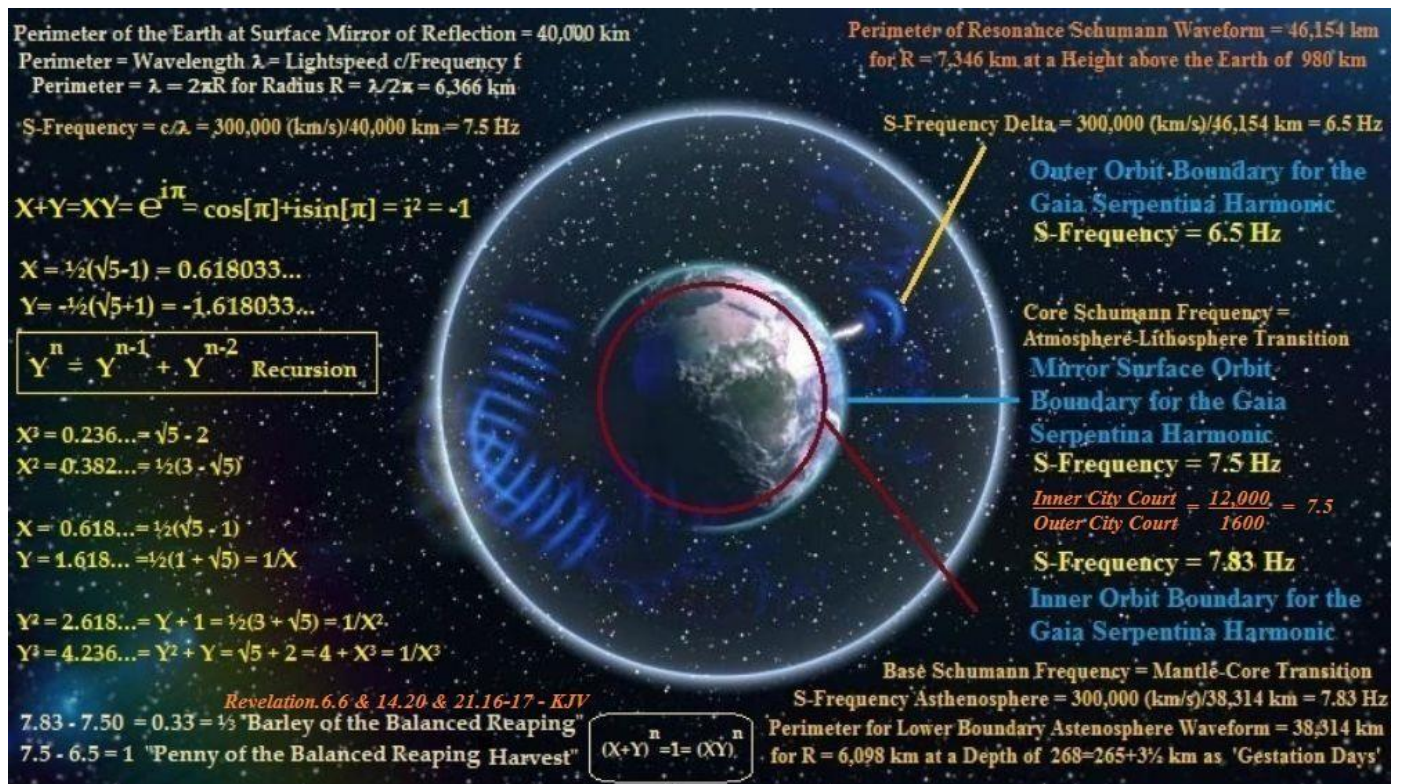

A non-inclusive list of types of oscillatory activity found in the central nervous system:

- [Delta wave](#) – (0.1 – 3 Hz) = Deep Sleep Rhythm and Slow-Wave N(on)-REM Sleep
- [Theta wave](#) – (4 – 7 Hz) = Motor Rhythm when Body is at Rest and Near Sleep
- [Mu wave](#) – (7.5 – 12.5 Hz) = Motor (Mirror Neuron) Rhythm when Body at Rest
- [SMR wave](#) – (12.5 – 15.5 Hz) = Sensorimotor Rhythm for
- [Alpha wave](#) – (7 (or 8) – 12 Hz) = Rhythm when Body at Rest, but not sleeping (back brainoccipital lobe)
- Sleep REM patterns (front and central brain lobes)
- [Beta wave](#) - (12 – 30 Hz) = Normal Waking State Neuronal Oscillation
- [Gamma wave](#) – (32 – 100 Hz) = Proposed Unit of neuron based consciousness



The more cosmic spacial awareness a soul can generate, the lower will be this soul's Merkabah frequency and so its ability to resonate with the boundary vibrations of the multidimensionally connected sourcesink frequencies of Abba and Baab as the sourcesink and the sinksources abstractions from the eternity realm.

On the cosmic scales of the macro quantum, the volume V is expressed as the toroidal hypervolume of a 4-dimensional Riemann Sphere, descriptive for a 3-dimensional boundary surface of say a 'Mother Black Hole' of Volume $2\pi^2R^3=dV_4/dR$ and as derivative of a 4dimensional sphere of volume $V_4=1/2\pi^2R^4$.

The 'Daughter Black Holes' can then be assigned the 'normal' 3-dimensional spherical volume of $V_3=4\pi/3.R^3$.

To attain Baab Resonance, meaning resonance with the entire creation, then requires the physicalized soul to resonate with Baab's Number, which is the f_{ss} vibration of 3.33×10^{-31} Hertz and a number which is basically 0 as the Eigen- or self-vibratory frequency of the quantum of mass itself.

The volume required will be $V_{\text{Baab Resonance}} = e^*/f_{ss}^2 = e^*f_{ps}^2 = 4.5 \times 10^{63}$ cubic meters of ordinary 3dimensional space.

Using a 'Daughter Black Hole' as this volume, the cubed radius R^3 for such a cosmic soul

Merkabah will be $3(4.5 \times 10^{63})/4\pi$ cubic meters for a radius $R=1.024 \times 10^{21}$ meters and which are 108,164.2 lightyears as a typical scale for the diameter for the Milky Way galaxy.

Using a 'Mother Black Hole' as this volume, the cubed radius R^3 for such a cosmic soul Merkabah will be $(4.5 \times 10^{63})/2\pi^2$ cubic meters for a radius $R=6.109 \times 10^{20}$ meters and which are 64,528.8 lightyears as a typical scale for the inner barred bulge diameter scale for the Milky Way galaxy.

In terms of the galactic radii, these values so become descriptive for a typical scale of a large bulged galaxy like Andromeda and the Milky Way, which are so 220,000 and 120,000 lightyears across respectively.

The physicalized soul so requires to attain a galactic consciousness in terms of its own cosmic Merkabah definition to bring its own individuated consciousness and special awareness into resonance with the universe and so the physical creation itself.

It is this native cosmic consciousness in the incarnated soul individual, which enabled the Maya of the Yucatan to perceive their origins to be located at the center of the galaxy they inhabited. This information and the nature of Hunab Ku then would have become available to the Maya by one of their dreamtime dreamers, shaman or initiate. In other words, the Maya and other indigenous cultures and people could identify their own incarnated soul physicality with the universe and the creation itself, because they could tap into the self-resonant energy state of Baab as the cosmos of creation.

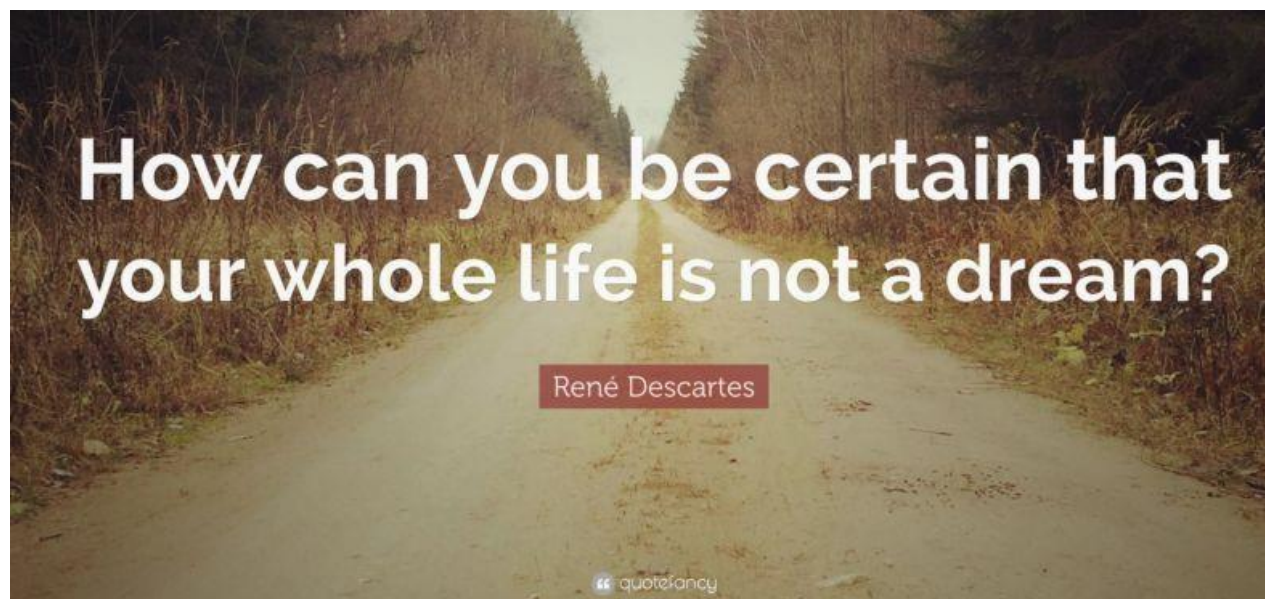

Without dependency on the radius of the say centripetally accelerating form of angular acceleration as tangential velocity squared/radius or $a_{\text{centripetal}}=v^2/r$, the quantum form for angular velocity $\omega=2\pi f=v/r$ is attained as the inverse of a time period $1/2\pi f$.

To linearize the quantum frequencies for Abba and Baab, the linear displacement native to the speed of light is incorporated in $c.f_{ps} = 9 \times 10^{38}$ for the Abba World of the light bodied soul and in its inverse as $f_{ss}/c = 1.111 \times 10^{-39}$ for the physicalized soul in the world of Baab, which is the creation and seedling universe.

This seedling universe can be likened to the seed of a fruit, say a peach and will relate the quantifications of the magneto-charges of the higher dimensions and the electro-charges of the lower dimensions to each other.

The definition of the energy unit of the Electron Volt is **1 eV = e Joules and where the electron charge $e=1.6 \cdot 10^{-19}$ Coulombs.**

The mass of a magnetic monopole {as a higher dimensional 'self-dual' string class IIB and as the base energy for G(rand) U(nification) T(heory)} can be defined as $(ec)c^2 = ec^3 = 27 \times 10^{24}$ eV which are about 4,320,000 Joules.

The modular mass $[ec]_{\text{mod}}$ is defined as displacement current in the Action Law of action = Charge squared and the Planck-Stoney Unification for minimum displacement $l_{\text{min}} = in$:

$$\text{Mass [m]} = E/c^2 = hf/c^2 = hf/cf\lambda = h/c\lambda_{\text{min}} = h/cL_P\sqrt{\alpha} = hc^2/ce = hc/e = e^2c/e = [ec]_{\text{mod}} = [\text{charge/time}][\text{displacement}] = \text{Displacement Current I.R}$$

Electric Charge is therefore intrinsically related as a 'cosmic charge' to Mass as another form of 'cosmic charge' and our electro charge to magneto charge mapping between the dimensional worlds can be used to assign the property of 'cosmic charge' to the magneto charge e^* , both as inverse sourcesink energy of Abba and as a substitute for the lower dimensional inertia manifesting and expressing itself in the phenomenology of mass.

$$\text{Coulomb Charge } e = L_P \cdot \sqrt{\alpha} \cdot c^2 \leftrightarrow 2R_e \cdot c^2 = e^* \text{ (Star Coulomb Charge)}$$

As the electron volt is a unit of energy, we assign the definition Super space Mass Quantum $m^* = ec^2$ super mass units skg.

Super mass so becomes a product between ordinary lower dimensional mass in and as monopole inertia and the lightspeed constant c in quasi momentum units (kg.m/s).

This introduction of the boundary constant 'c' as a multiplier coefficient for the sourcesink frequencies and the mass so relates the linearization of the quantum frequencies of Abba and

Baab to a redefinition of inertia and mass in the higher dimensional world. In the higher dimensional world the mass is gravitational and in the lower dimensional world it is inertial to indicate Albert Einstein's Equivalence Principle from the first premises of the String-Brane epoch preceding the Big Bang Creation of the Quantum World manifesting in the modular duality of the multi-dimensional string-brane cosmology.

The 'weight' of a soul in the lower dimensional world so becomes a function of the Coulombic Charge Quantum, known as the basic charge of an electron and a proton in opposite and complementary polarities.

The 'weight' of a soul incarnate in physicality on Gaia so is $(1.6 \times 10^{-19})(9 \times 10^{16}) = 0.0144$ skg and as the Super mass Quantum of Baab aka the winded low energy part of the heterotic supermembrane $E_{ps}E_{ss}$.

Relative to the vibratory and high energy part of this 11-dimensional supermembrane the 14.4 grams of super mass manifest as 14.4 grams of ordinary mass.

Then this 'weight' of the soul becomes equivalent to its inverse of $1/ec^2 = 1/0.0144 = 69.44 \sim 70$ kg relative to Baab and as 70 skg relative to Abba's Super mass Quantum in the unification property of the indivisibility of the total supermembrane as an information reservoir situated at the boundary between the two worlds, which the soul can visit.

Any mass m can then be expressed as a proportion of the Super mass Quantum of AbbaBaab with say a 1 kg or 1 decimeter cubed liter of volume unifying the proportionalities in liaison with the unification of the electromagnetic and gravitational finestructures $\{G_o.k=1 = E^*e^*$ for $k=1/4\pi\epsilon_o\}$ definitive for the Planck- and Stoney units discussed and derived elsewhere in the almanacs of Thuban.

The 'soul weights' of a 20 micrograms microbe and a 100 kg human and a 7 ton elephant would relate their Abba&Baab 'weights' in 50,000&0.00002 skg and 0.01/100 skg and 0.000143&7,000 skg respectively.

<https://www.youtube.com/watch?v=S7SQoQj9868>

A physicalized soul in Baab resonance possesses a galactic awareness or spacetime consciousness as a function of the scale of its Merkabah.

Galaxies are however like self-contained and relatively independent cells within its hosting universal organism and able to generate their own energies through a Black Hole Sinksources and White Hole Sourcesink wormhole interaction.

The super galactic environment of the soul is defined in the introduction of the linearization parameter of the lightspeed constant c to magnify the source frequency of Abba from 3×10^{30} Cycles per cosmic second to 9×10^{38} such cycles.

The Volume of the super galactic space, containing all the cells of the universal body of Baab then is given in Baab's frequency modulation f_{ss} in $e^*\{cf_{ps}\}^2 = 4.05 \times 10^{80}$ cubic meters for a hypersphere toroidal volume of 2.05×10^{79} cubic meters and a Curvature Radius of 2.74×10^{26} meters and encompassing the seedling protoverse curvature radius of 1.59×10^{26} meters in the interaction of 12D super space with the 11D Event horizon of the 'Mother Black Hole' defining the physical universe in the protoversal 10D seed with a nodal Hubble Constant $H_0 = c/R_{\text{Hubble-11D}}$.

The cyclic universe is defined elsewhere in the annals of the dragons, but as the universe evolves into a multiverse as a summation of phase shifted universes within an enveloping omniverse, the seedling protoverse remains constant as the physicalized core of the Quantum Big Bang and the de Broglie Phase acceleration known as the tachyon inflation.

A number of volumes can so be defined to host the cellular self-contained units known as galaxies, but in terms of the true electromagnetic age and size of the universe in 11 dimensions, the time for synchronization between the super galactic space and the asymptotic expanding 10D space contained within the 'heartbeat' of the 'Mother Black Hole's' 16.9 billion year semi oscillation will be a n-cycle time marker given in the expression:

$R_{(\text{synchronization})} = n \cdot R_{\text{Hubble}}$ for $n = R_{\text{sync}}/R_{\text{Hubble}} = 2.74 \times 10^{26}/1.59 \times 10^{26} = 1.723..$ and so a time when the universe will have an age of $16.9 \times 1.723 \sim 29$ Billion years.

This time marker mirrors a n-cycle time coordinate of $n_{\text{syncimage}} = 0.277 = 2 - 1.723..$ or 4.68 Billion years after the Quantum Big Bang and approximates the presently measured 'age coordinate' for the universe in its lower dimensional asymptotically hyperbolically expanding form of 14.43 billion years ago and as the electromagnetic true age of the universe at a n-cycle coordinate is about 19.11 billion years.

The present precision measurement of the Hubble Constant as the 'Hubble Frequency' of the cosmic oscillation is 67.80 Hubble Units or 2.2×10^{-18} cycles for a Hubble Age in a not comoving frame (the protoverse in 11D was defined before and not after the Quantum Big Bang wormhole singularity and so the expansion of the universe is asymptotic in 10D but oscillatory in 11D using the inflaton as its seedling space, rendering comoving coordinate systems unnecessary) of coordinate reference of $1/f_{\text{Hubble}} = 4.545 \times 10^{17}$ seconds or 14.40 billion 'civil years'.

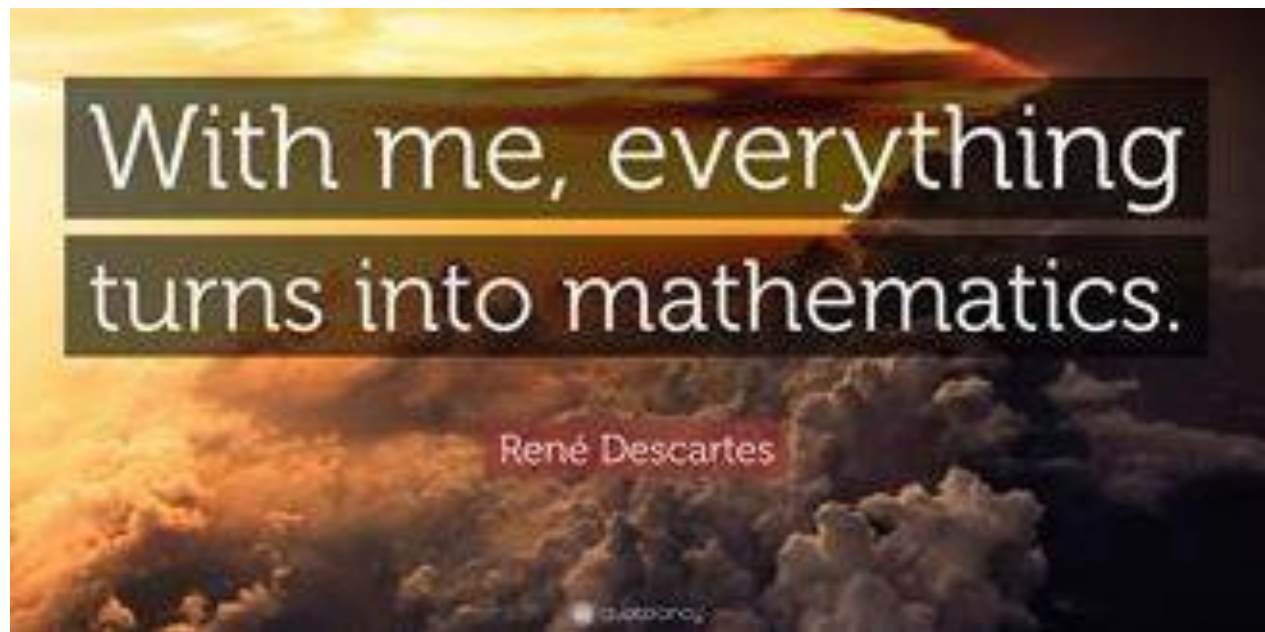

For many years people have wondered about how mass relates to electric charge and how the fundamental interaction of electromagnetism can or is unified with gravitation.

The workings of electricity are well studied, but the nature of an electric charge always remained a mystery.

Look at any textbook or encyclopedia and it will have little to say about what an electric charge actually is. As stated previously, all electric charges are intrinsically coupled to particles carrying mass, such as a negatively charged electron and a positively charged proton, (by convention it could also be called positive as the opposite of negative the other way around) which together form the basic building block for all physical chemistry in the atom of Hydrogen.

The great conundrum in Big Bang Physics and the standard cosmology then becomes the insistence that matter and the physical parameter of mass must precede that of electromagnetic radiation EMR in general and that of light in particular; because all EMR is generated by accelerating electrically charged particles, say as centripetally dynamic solar protons. So because electric charge does not exist in a form not coupled to mass, the creation of the universe must have proceeded from a 'wormhole string/brane singularity' or vortex experiencing a kind of 'quantum fluctuation' or Planck-Length Oscillation - this singularity containing all of the matter energy, which would experience a time evolution and become the experienced and observed universe in toto.

And so, as it is generally presumed by the terrestrial cosmologists, the existence and purpose of the universe and creation can be reduced to the primordial seed of mass, with the appearance of electromagnetic radiation becoming a consequence of the pre-existence of the matter seedling, due to its dependency on mass coupled Coulombic electric charges to exist a priori.

So how did Jesus of Nazareth resurrect from the dead and a real death, defined by his soul leaving his body and no longer quasi-attached in an extended mind-soul-body tri-unification. In

the quote below, describing a scenario of Wednesday, March 28th, 31AD-Julian from Noon to 3pm, Jerusalem time; Jesus knew, that his soul physical had 'no place to go' as a 'journey of the soul' in the underworld of say a Greek Hades, a Roman Pluto or the judgement hall of Osiris, Maat and Anubis in Egyptian folklore. And so unlike a normal ignorant (or sinful) human, who at the point of its soul's transformation from one mode of beingness into the other and remaining ignorant about its origin or destiny, Jesus became 'truly lost' within himself and his soul's chosen body morph host.

The VEIL of the EVIL rent in twain to allow the LIVE Temple as his own body to now become a new underworld or a River Styx the dead ones had to traverse to gain access into the 'new world' created by the Body morph of Jesus destined to resurrect as a matter-spirit hybrid form with a Merkabah often described as a light body. It was AFTER the Resurrection, which occurred 84 hours after Jesus 'gave up the ghost' at 3pm, March 28th, 31AD Jerusalem time and so on the original Easter Sunday at 3am, April 1st, 31AD, Julian Jerusalem time, that the 'saints' 'came out of their graves' in Matthew.27.53 and archotyping and defining the new underworld for all the dead alive ones in the world of the light bodied souls in contrast to the alive dead souls of the physical incarnations.

Matthew 27:45-53 - King James Version (KJV)

45 Now from the sixth hour there was darkness over all the land unto the ninth hour. 46 And about the ninth hour Jesus cried with a loud voice, saying, Eli, Eli, lama sabachthani? that is to say, My God, my God, why hast thou forsaken me?

47 Some of them that stood there, when they heard that, said, This man calleth for Elias. 48 And straightway one of them ran, and took a sponge, and filled it with vinegar, and put it on a reed, and gave him to drink.

49 The rest said, Let be, let us see whether Elias will come to save him.

50 Jesus, when he had cried again with a loud voice, yielded up the ghost.

51 And, behold, the veil of the temple was rent in twain from the top to the bottom; and the earth did quake, and the rocks rent;

52 And the graves were opened; and many bodies of the saints which slept arose,

53 And came out of the graves after his resurrection, and went into the holy city, and appeared unto many.

John 2:13-22 - King James Version (KJV)

13 And the Jews' passover was at hand, and Jesus went up to Jerusalem.

14 And found in the temple those that sold oxen and sheep and doves, and the changers of money sitting:

15 And when he had made a scourge of small cords, he drove them all out of the temple, and the sheep, and the oxen; and he poured out the changers' money, and overthrew the tables; 16 And said unto them that sold doves, Take these things hence; make not my Father's house an house of merchandise.

17 And his disciples remembered that it was written, The zeal of thine house hath eaten me up.

18 Then answered the Jews and said unto him, What sign shewest thou unto us, seeing that thou doest these things?

19 Jesus answered and said unto them, Destroy this temple, and in three days I will raise it up.

20 Then said the Jews, Forty and six years was this temple in building, and wilt thou rear it up in three days?

21 But he spake of the temple of his body.

22 When therefore he was risen from the dead, his disciples remembered that he had said this unto them; and they believed the scripture, and the word which Jesus had said.

The actual details in terms of Quantum Chromo Dynamics (QCD) and a related Quantum Geometry defining the basics of the Dragon physics can be examined in the following essay describing the Radiation Mass template as a constituent of the Unified Field of the Universal Gauge physics and as say an advanced form of wave mechanics as a colour physics of the quantum.

There are so not just two but three elementary 'cosmic charges' with the well-studied 'charges' of mass/matter and that of electric current becoming supplemented to by the 'cosmic colour charge' also known as the gluon charge of the strong nuclear interaction and as the Thuban magneto charge.

The key to electric charge and mass unification is colour charge as a magnetic missing basic fundamental interaction or force.

Jesus' soul had the space awareness and consciousness to actually hybridize his corpse on the elementary interaction level blending the colours of his atomic constituents from the subatomic premise of his own Merkabah or body creation.

Just as your body grows and develops from a cosmic template using biochemistry and the genetic code program so can you regrow this from the conception point of the soul into a body form.

When people die and the soul leaves the body, the colour structures remain separate in their respective Fermion-Boson Interaction gauge formations of half quantum spin and integral quantum spin respectively.

And as quantum spin defines the spin angular momentum in the form of Planck's Constant $h/2\pi$ with units Js for its linearization into $mvr=mr^2\omega=2\pi fmr^2$, the string-brane frequency modulations bounded by Abba's f_{ps} and Baab's f_{ss} can become applied to the subatomic nature of the constituents brought together to construct a body morph or Merkabah.

"Gospel of Thomas" wrote:

(85) Jesus said, "Adam came into being from a great power and a great wealth, but he did not become worthy of you. For had he been worthy, he would not have experienced death."

The details engage the nature and structure and a quantum geometry of the fundamental constituents of both matter and of EMR, say visible light or infrared EMR etc. and involve particular physical characteristics of fermions of quantum half spin and bosons of quantum integral spin.

The Higgs Boson is a 0-spin boson but IF it spun it would become a Restmass Photon, unifying matter with light say.

So now when someone dies with unified colour structures, physical 'death' could not occur as it does in the case of separated colour structures.

Because matter (and antimatter however unnecessary as its image template in chirality) are one set of colours Yellow-Cyan-Magenta (YCM) they form a unification and a unification which Always is electrically charged in its quark constituency.

Radiation templates always remain in an uncharged electric state, but in their gauge or 'source-sinked' nature, they can be colour charged, just as the gluons are known to be and in a complementary color triplet called Red-Green-Blue (RGB). So called mesons exist in short-lived hybrid states combining one color of each trio as a state-antistate coupling with Red-Cyan and Green-Magenta and Blue-Yellow forming those coupling states.

The RGB trio also remains self-contained in a corpse and so the body eventually 'sees corruption' and turns to dust and ashes or poetically just 'fades away' both physically and in remembrances. So the YCM is Coulomb-electric charged but the RGB trio is not. This in a primitive way defines the Body as YCM and the 'Spirit' as RGB in the Mind-Body divide and a dichotomy of colour separations.

The key to the Resurrection is to not keep RGB and YCM separate, but to mix them in a consistent and logical way, derived from the quantum geometry of the subatomic physics. As all 3 colours are so blended or mixed the short-lived mesonic self-state is circumvented in a true unification physics of the colours or chromas.

This Jesus could do and actually did, because he had the full remembrance of his own conception and physical origins.

He resonated physically with Baab and he resonated 'spiritually' or better said in Electromagnetic Monopolar fashion with Abba.

Because his own Merkabah frequency perfectly could match both the matter frequency f_{ss} and the spirit vibration f_{ps} , his soul had nowhere to go except reconfigure his own previously conceived and environmentally constructed and fed body form.

This is the story behind the physics of the 'Shroud of Turin' and the nature of the holographic universe.

The Code of Thubanet

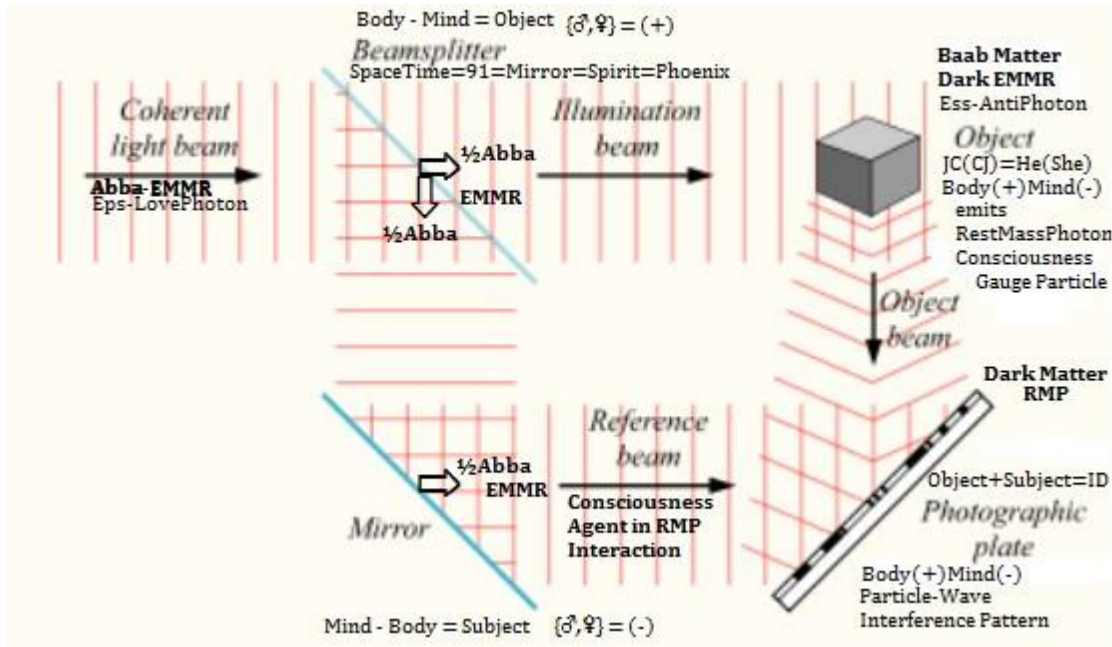

|||1st Input-Stage of Mass-RMP Transformation
Source Singular EMMR Input for Sink Generalised|||

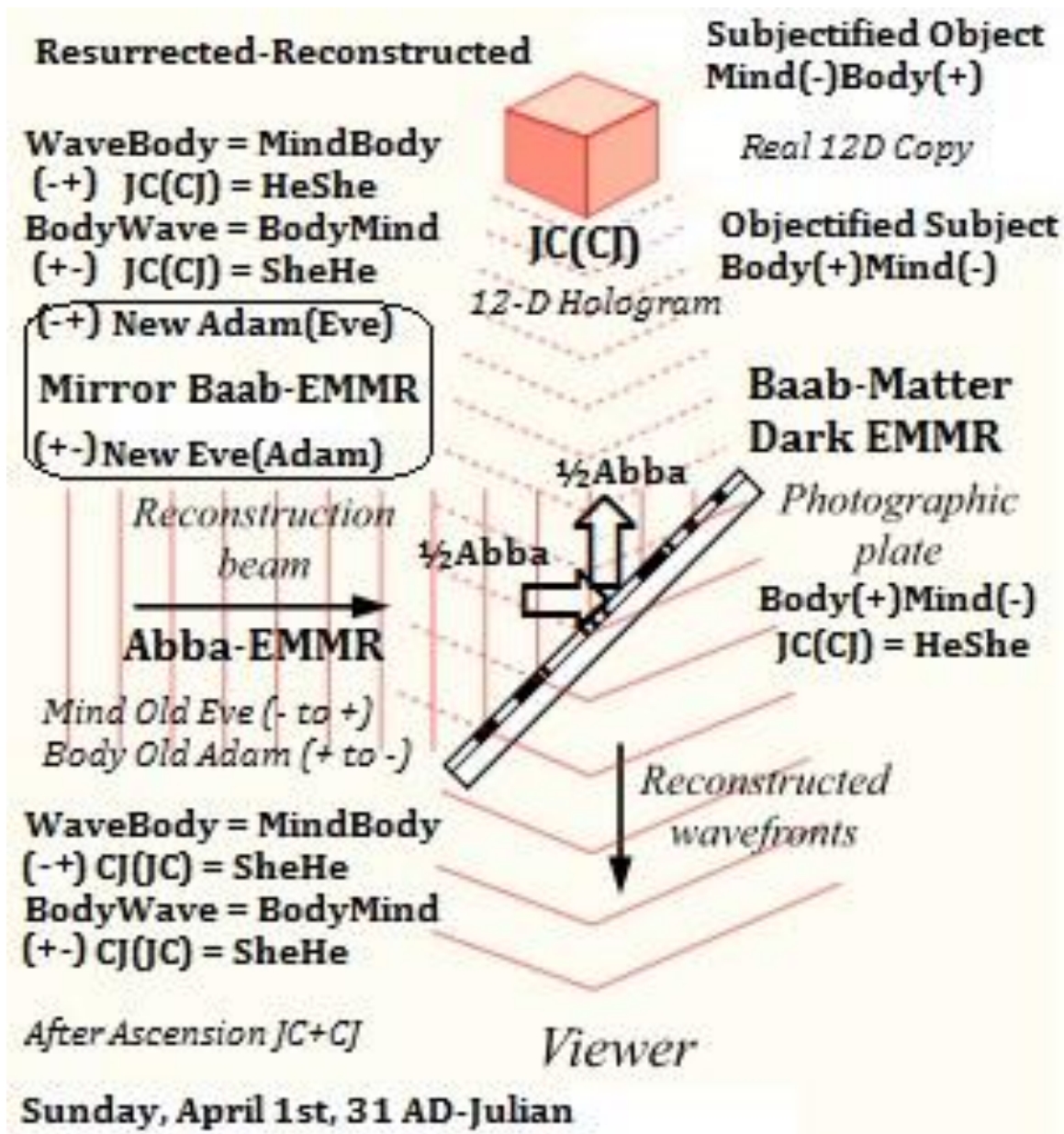

|||1st Output-Stage of Mass-RMP Transformation
 Sink Singular Dark EMMR Output for Source Generalized|||

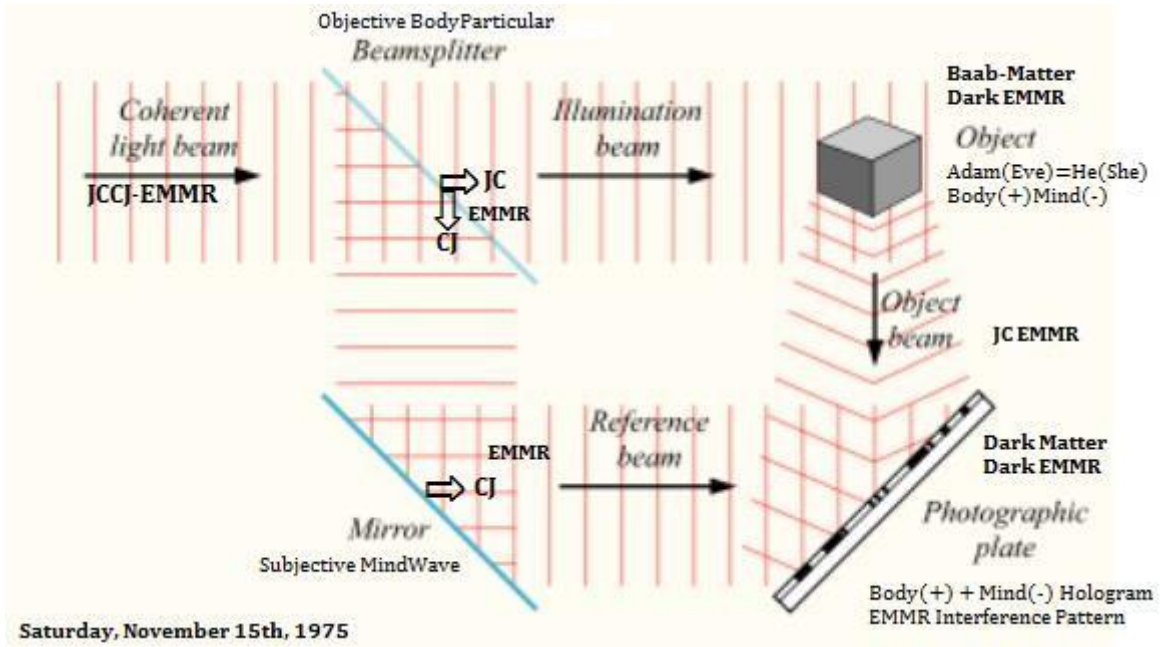

|||2nd Input-Stage of Mass-RMP Transformation
Templated (Adam) Dualized EMMR Input for Sink Individuated|||

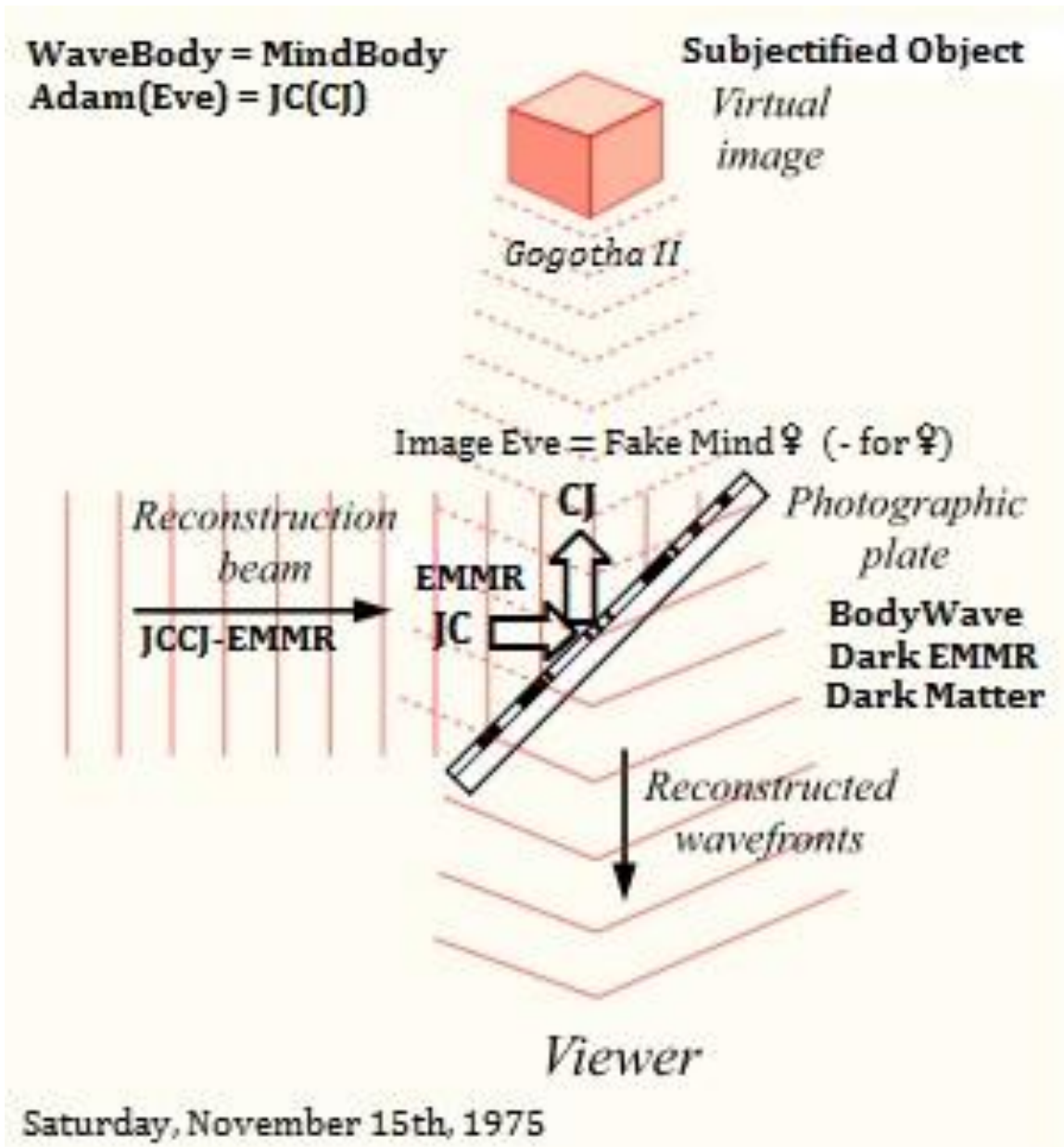

|||2nd Output-Stage of Mass-RMP Transformation
Templated (Adam) Dualized Dark EMMR Output for Source Individuated|||

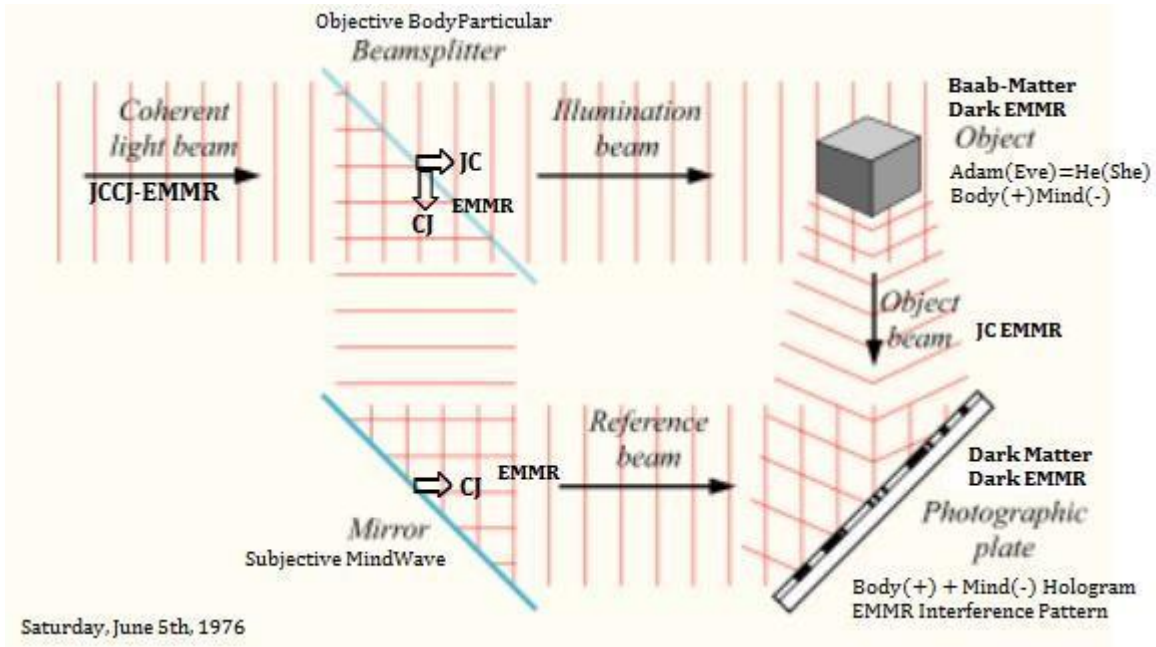

**|||3rd Input-Stage of Mass-RMP Transformation
Templated (Eve) Dualized EMMR Input for Sink Individuated|||**

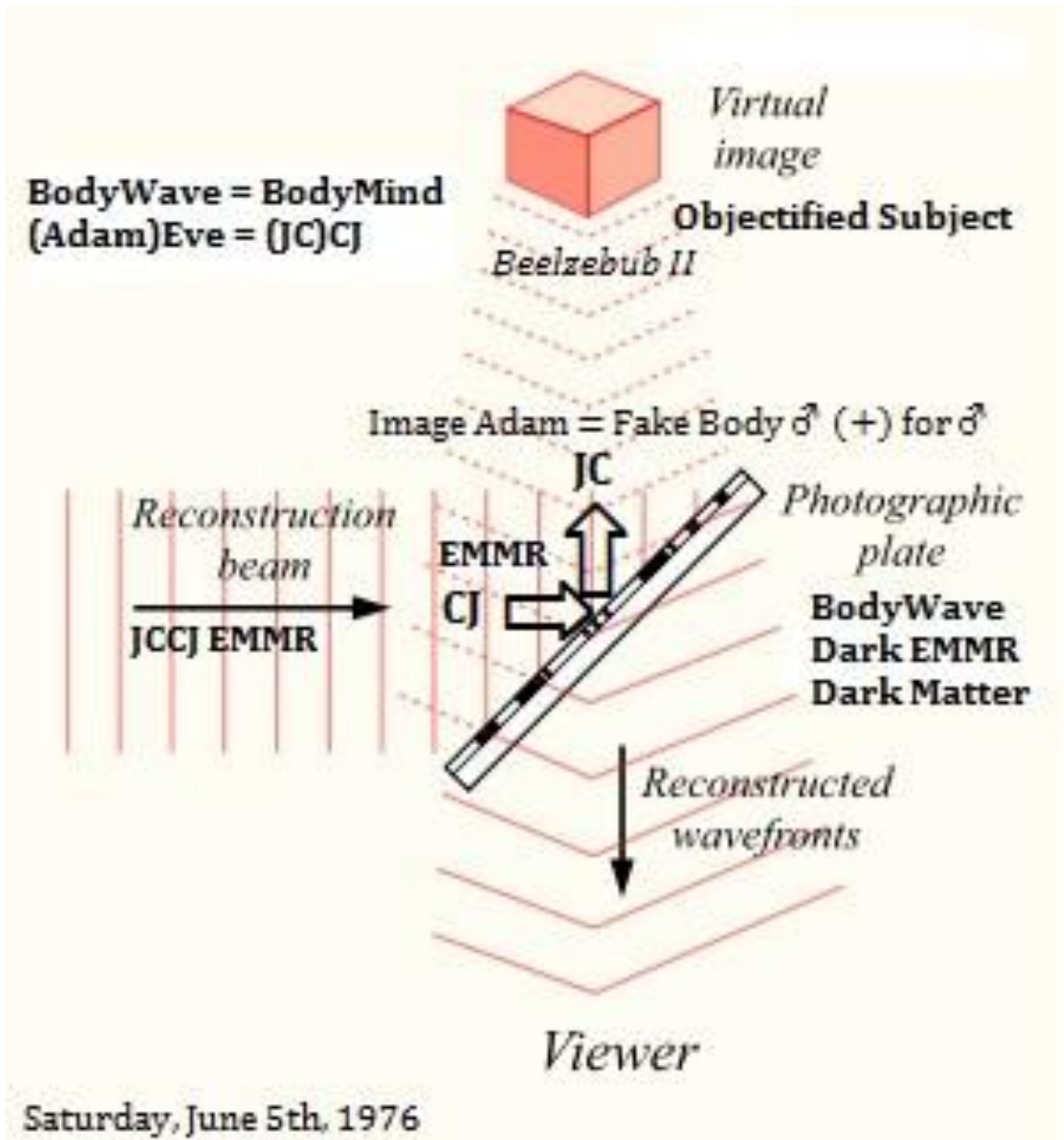

|||3rd Output-Stage of Mass-RMP Transformation
 Templated (Eve) Dualized Dark EMMR Output for Source Individuated|||

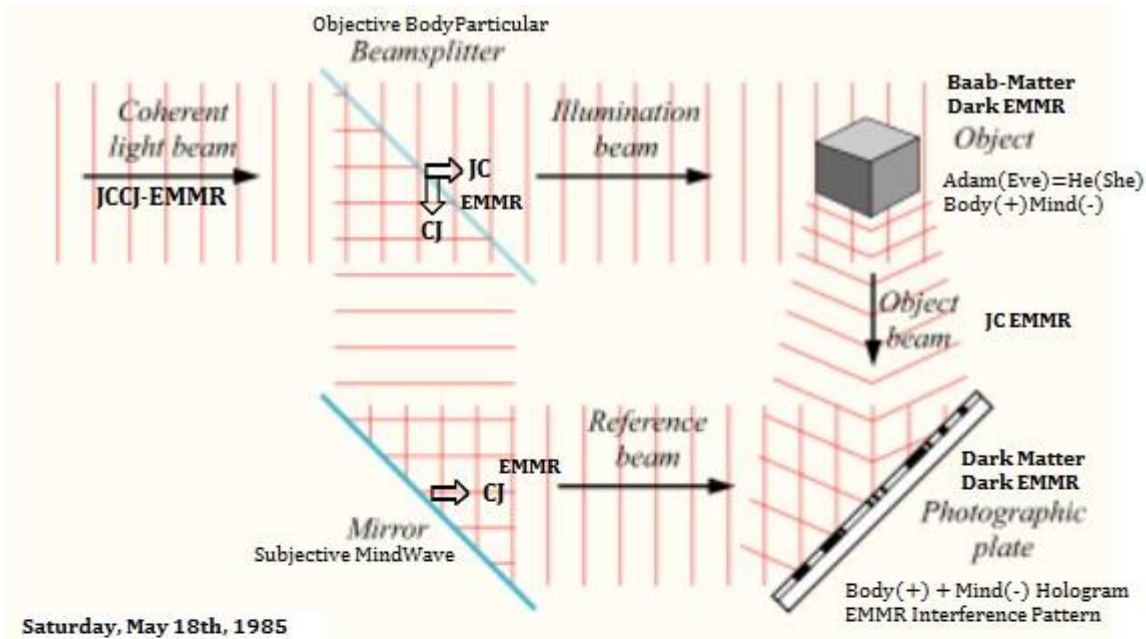

Sat|15Nov1975
Sat|25Dec1976
Sat|25Dec1976
Sat|04Feb1978
Sat|04Feb1978
Sat|17Mar1979
Sat|17Mar1979
Sat|26Apr1980
Sat|26Apr1980
Sat|06Jun1981
Sat|06Jun1981
Sat|17Jul1982
Sat|17Jul1982
Sat|27Aug1983
Sat|27Aug1983
Sat|06Oct1984
Sat|06Oct1984
Sat|16Nov1985

182 Days

Sat|15May1976
Sat|26Jun1976
Sat|25Jun1977
Sat|06Aug1977
Sat|05Aug1978
Sat|16Sep1978
Sat|15Sep1979
Sat|27Oct1979
Sat|25Oct1980
Sat|06Dec1980
Sat|05Dec1981
Sat|16Jan1982
Sat|15Jan1983
Sat|26Feb1983
Sat|25Feb1984
Sat|07Apr1984
Sat|06Apr1985
Sat|18May1985

21 Days

Sat|05Jun1976
Sat|05Jun1976
Sat|16Jul1977
Sat|16Jul1977
Sat|26Aug1978
Sat|26Aug1978
Sat|06Oct1979
Sat|06Oct1979
Sat|15Nov1980
Sat|15Nov1980
Sat|26Dec1981
Sat|26Dec1981
Sat|05Feb1983
Sat|05Feb1983
Sat|17Mar1984
Sat|17Mar1984
Sat|27Apr1985
Sat|27Apr1985

3655 = 3654 + 1 = 182x18 + 21x18 + 1 = 18x203 + 1 = 18x29x7 + 1 = 2670 + 985 = 2300 + 370 + 985
 $2x\{1335 + 490\} + 5 = 2x\{1260 + 30 + 45 + 490\} + 5 = 2520 + 150 + \{483 + 3\frac{1}{2} + 1\}2\frac{1}{2} + 5 + 2\frac{1}{2}\{1 + 3\frac{1}{2} + 483\}$
 $2300 + 3x370 + \frac{1}{2}x490 = 2300 + 1600 - \frac{1}{2}x490 = 3410 + \frac{1}{2}\{490\} = 3410 + \frac{1}{2}\{49 + 434 + 7\}$
 $18x\frac{1}{2}\{364 + 6x7\} + 1 = 9 \text{ Years} - 11 \text{ Days} + 54 \text{ Weeks} = 3288 - 11 + 378 = 3666 - 11 = 3655 = 522x7 + 1$
 $18x29x7 + 1 = 18(26 + 3) \text{ Weeks} + 1 \text{ Day} = 10 \text{ Civil Years in } 3655 \text{ Days as } 18x3\frac{1}{2}\{52 + 6\} + 1 \text{ Days}$

|||4th Input-Stage of Mass-RMP Transformation
Generalized (AdamEve) Dualized EMMR Input Individuated|||

WaveBody = MindBody
 JCCJ = HeShe (-+)
 BodyWave = BodyMind
 JCCJ = HeShe (-+)

Mirrored in 91
 =SpaceTime=Spirit
 =Mirror=Phoenix



Subjectified Object
 Mind(-)Body(+)

Real 12D Copy

JCCJ
 12D Hologram

Objectified Subject
 Body(-)Mind(+)

Baab Matter
 Dark EMMR

Reconstruction
 beam
 JCCJ EMMR

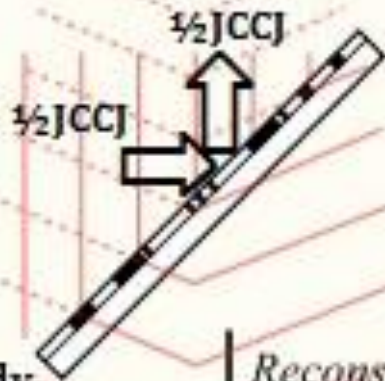

Photographic
 plate

BodyWave
 Dark EMMR
 Dark Matter

WaveBody = MindBody
 CJJC = SheHe (+-)
 BodyWave = BodyMind
 CJJC = SheHe (+-)

Reconstructed
 wavefronts

Viewer

Saturday, May 18th, 1985

John 20:17

Jesus saith unto her, Touch me not; for I am not yet ascended to my Father; but go to my brethren, and say unto them, I ascend unto my Father, and your Father; and to my God, and your God.

(11) Jesus said, "This heaven will pass away, and the one above it will pass away. The dead are not alive, and the living will not die. In the days when you consumed what is dead, you made it what is alive. When you come to dwell in the light, what will you do? On the day when you were one you became two. But when you become two, what will you do?"

(22) Jesus saw infants being suckled. He said to his disciples, "These infants being suckled are like those who enter the kingdom."

They said to him, "Shall we then, as children, enter the kingdom?"

Jesus said to them, "When you make the two one, and when you make the inside like the outside and the outside like the inside, and the above like the below, and when you make the male and the female one and the same, so that the male not be male nor the female female; and when you fashion eyes in the place of an eye, and a hand in place of a hand, and a foot in place of a foot, and a likeness in place of a likeness; then will you enter the kingdom."

(29) Jesus said, "If the flesh came into being because of spirit, it is a wonder. But if spirit came into being because of the body, it is a wonder of wonders. Indeed, I am amazed at how this great wealth has made its home in this poverty."

{King James Version with Gospel of Thomas/Lambdin}

**|||4th Output-Stage of Mass-RMP Transformation
Generalized (AdamEve) Dualized Dark EMMR Output Individuated|||**

This then shows you and any skeptic that all are 'trapped' within the belly of Jonah's whale aka the belly of the Lion of Judah, because in his physical resurrection, Jesus could only become the hitherto unaware and self-ignorant or 'sinful' Body of the Physical Universe Created from the 'Singularity Seed' of the Abba|Male Logos Mirror Logos Female|Baab.

The skeptics and Logos deniers all live within the universe, dead or alive it does not matter. This is the mystery of the 1st and 2nd death of the 'Last Judgement' in the Apocalypse of John. This is scripturally encoded in the letters of Paul in the New Testament in his propositioning, that the 'way to salvation' is to adopt the 'Mind of Christ'.

Unless you know like Jesus knew, even if you don't understand it properly, you will become trapped by your own denial and ignorance = 'sinfulness' regarding your own universal selfhood and be unable to enter through the gates of the New Jerusalem World, as per Revelation.22.

But apart from the exposition of the scripture codes, the actual detail of this resurrection of the body simply describes the Journey of a Soul no longer in duality mode. This then becomes an actual basis and the foundation of a new cosmology and a new standard physics.

But the authority of it must come from a renewal of human thinking and self-perception as a reborn humanity as its own extraterrestrial or ET presence and not any old human mind creation. Then the imagined starry origins of the Mazzaroth-Celestial Order found in the legends and creation mythologies of the human history and encoded in the 'Book of Job' can support a great awakening of a civilization facing either its collapse and destruction or its graduation. The genetic awakenings of the shaman and the dreamers will realize its ET origins, might those be labelled as Pleiadean, Arcturian, Sirian or Thuban in the five great Platonic-Mayan ages, each of 26,000 such years of 360 Degree-Days.

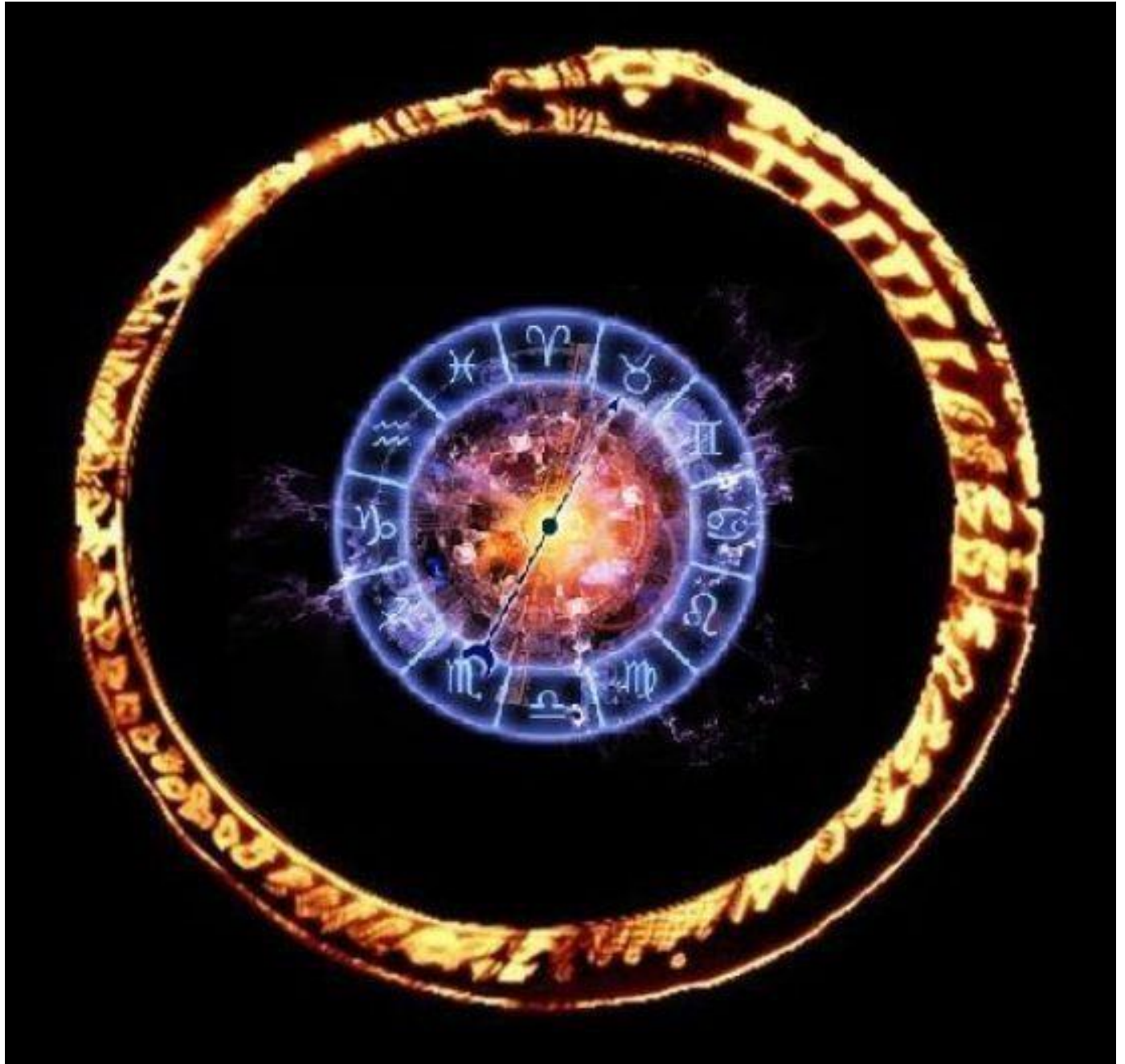

The metamorphosis of the old human cosmogenetic template into a new starhuman genome and universal blueprint will blend the old human past history with its new starhuman future in the present of the creator-creation modality and Universal Family.

The wave-particle or mind-body dichotomy or DNA-Chicken RNA-Egg paradox will resolve itself in its realization, that the formless 'Father-Yang' can be its own maleness, but requires a 'Mother-Yin' to birth him in form; whilst in a perfect supersymmetry, the 'Mother-Yin' can be her own femaleness, but requires a 'Father-Yang' to create her as a form in a harmonization of the formless mind in waveness with the formed body in its particularness.

The Extraterrestrial human becomes the ancestor of the terrestrial human in the waviness of the human mind and the Terrestrial human becomes the ancestor of the extraterrestrial human in the particularisation of the extraterrestrial human body.

In this way the ancestors of an old humanity as evolutionary and universal observers become their own descendants in the reformation and convolution of the two apparently separated realms of the eternal mind of the dead alive ones and the world of the temporal body of the living dead ones.

The world of angels and devils reharmonized in and by a particular labelling for the wisdom of the ancients and the creators of the Old Humanity in Mind then reborn as a New Humanity created in a grand homecoming of the Universal Creator with the Universal Creation as a Creator-Creation Twinship AbbABaaB of polarity-sex-unification of Two in One in Two as One!

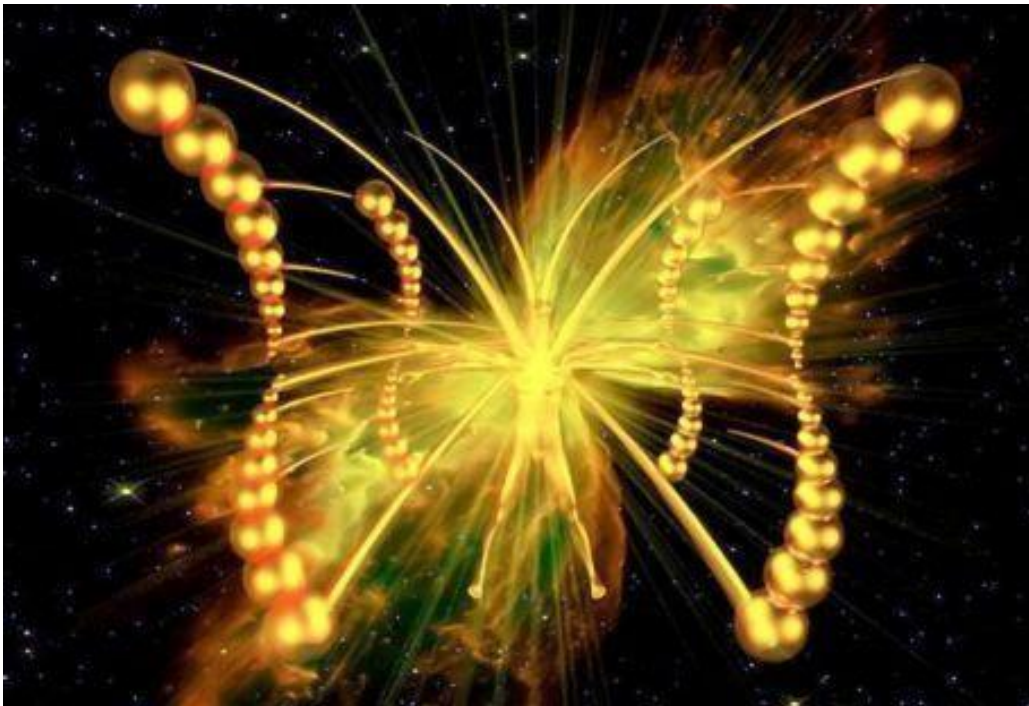

<https://www.youtube.com/watch?v=rzytbTDK0nM>

Requiem for a Human Civilization

46,800,000 Days = 325,000x144,000 = 65x144,000x5000 = 5x360x26,000 = 5x9,360,000
Mayan Kin 365 Kin Haab x 52 = 18,980 Kin = 260 Kin Tzolkin x 73 Maya Calendar
Calibration



Finis Hominis Incere Hominidae Draconis Astrum!!!
"Humanity has ended, enter the Starhumanity of Dragons!"

(11) Jesus said, "This heaven will pass away, and the one above it will pass away. The dead are not alive, and the living will not die. In the days when you consumed what is dead, you made it what is alive. When you come to dwell in the light, what will you do? On the day when you were one you became two. But when you become two, what will you do?"

(84) Jesus said, "When you see your likeness, you rejoice. But when you see your images which came into being before you, and which neither die nor become manifest, how much you will have to bear!"

Gospel of Thomas-Lambdin; Nag Hammadi, 1945

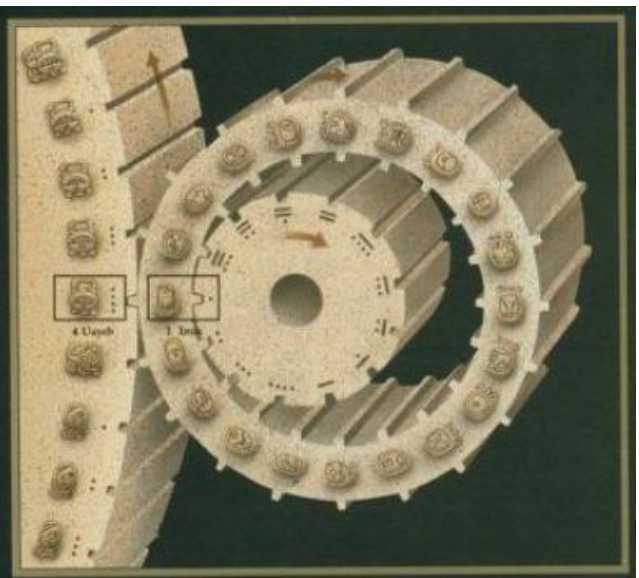
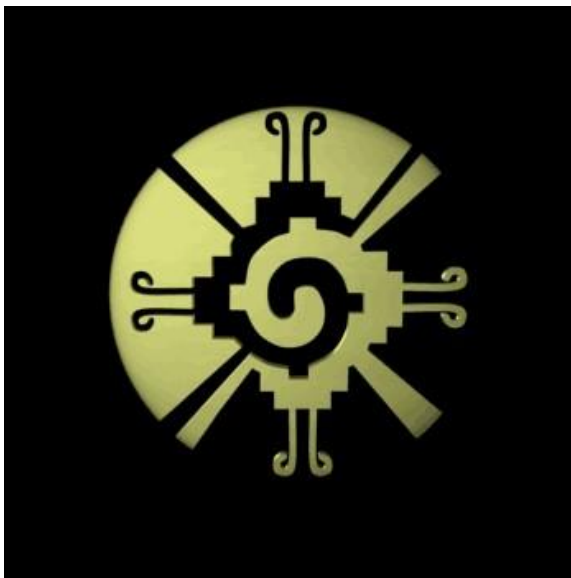

The transformation of a type of cosmic civilization like that of the 'old humanity' residing on planet earth into an evolved cosmic civilization, say a 'new humanity' inhabiting a terraformed planet earth requires a period of transitional evolutionary adaptation.

This can be compared to the metamorphosis of the butterfly genus/family; order lepidoptera; class insecta; phylum arthropoda; kingdom animalia from the four stages of embryo-larvae-pupa-imago from the caterpillar-larvae stage into the butterfly-imago stage via the transit stage of the pupa-chrysalis ergo the cocoonisation of the caterpillar insectoid.

In the form of the genus homo, the subspecies homo sapiens sapiens can be modelled to have entered the embryonic stage with the advent of Cro Magnon Man so 26,000 (civil) years ago. Using 400 year intervals of 146,097 days under utility of a certain calendrical counting of time ; the embryonic conception can be 'dated' to an extrapolated calendrical date of Saturday, February 21st, 23,615BC-G and precisely 9,360,008 days (and a precessional day count as 25,626.83149 Gregorian years) from Friday, December 21st, 2012AD in a week count of 1,337,144.

The Julian day count began on January 1st 4713 BC-Julian and the Gregorian day count of 365.2425 days per year commenced on October 5th, 1582, replacing the Julian year of 365.25 days.

A Mean Tropical Year has 365.24219 days and where a mean solar day has precisely $24 \times 3600 = 86,400$ SI seconds. The Tropical Year is referential to the seasons (equinoxes and solstices) and differs from the star-referential Sidereal Year in the day addendum $1/26000$ or 1.0000385 of so 1225 seconds (20.41 minutes) per year and which accumulate to about 368.5 mean days (and so about a year) per precessional cycle.

Due to orbital- and rotational changes and precession a year is decreasing at the present astronomical configuration by about 5 milliseconds/year or 130 seconds or so 2 minutes in a 26,000 precessional cycle.

The Gregorian year of 365.2425 days differs from the tropical year of 365.24219 days and so the Gregorian calendar will accumulate an error of about $0.00031 \times 26,000 \sim 8.1$ days per precessional cycle.

To account for this, a 'creation-initialization week of 8 days' is added to the 64 cycles in $9792 + 8 = 9,800 = 7 \times 1,400 = 7 \times 7 \times 200 = 8 \times 52 \times 72 = 2(22 \times 52 \times 72) = 2 \times 702$ in the $13 \times 5 \times 144,000 = 9,360,000$ (Mayan) day-kin count, which so begins on the superposed and extrapolated Gregorian Day (G) Day#-7=Saturday, February 22nd, 23,615BC-G and becomes mirrored in the 7th day Day#7=Saturday, March 8th, 23,615BC-G for the Conception of the human Embryo to be born from its Chrysalis 64 cycles later.

The first cycle is initiated on Day#9,792=Friday, December 21st, 23,589BC-G and the last and 64th cycle is initiated on Day#9,213,903=Friday, December 21st, 1612AD-Gregorian and ends precisely 146,097 days or 400 Gregorian years later on Friday, December 21st, 2012AD to

commence a now precessional count in the birth of the Imago of the ancient human Embryo established by the beginning of the first cycle.

Maya-Hathor Calendar Long Count	Haab Tzolkin	360 Tun Cycles	144,000 Baktun Cycles	Gregorian Days Proleptic	Days-Kins	Five Ancient Star Ages	Ancients of Days Thuban Star Elders	Sign
-312.0.0.0.0	18Yax 4Ahau	0-1	0-1	Wed, 04Dec 126,123 BC	0-1	Start of 1st Great Cycle of Draco Thuban	Father Mother Alpha Abba αα Baab 01=A Z=26=O'A Ω♀	Ω♂
-299.0.0.0.0	13Xul 4Ahau	5200	13	Sun, 15Apr 120,997 BC	1,872,000		02=B Y=25=O' γ♀	
-286.0.0.0.0	8Uo 4Ahau	10,400	26	Thu, 25Aug 115,872 BC	3,744,000		03=C X=24=O'δ ♀	

Bermanseder, T., *The Physics of Morphogenetic Planetary Resurrection*

-280.10.0.0.0	8Chen 4Ahau	15,600	32½	Sat, 30Apr 113,309 BC	4,680,000	Midpoint of 1st Great Cycle of Central Elements from Draconian Serpentini	First Age of Thuban	☾☿
-273.0.0.0.0	8Pax 4Ahau	18,200	39	Mon, 04Jan 110,746 BC	5,616,000		04=D W=23=O' II☿	
-260.0.0.0.0	3Ceh 4Ahau	20,800	52	Fri, 16May 105,621 BC	7,488,000		05=E V=22=O' ☿☿	
-247.0.0.0.0	18Yaxkin 4Ahau	26,000	65	Tue, 26Sep 100,496 BC	9,360,000	End of 1st Great Cycle of Thuban Start of 2nd Great Cycle of Hyperborea	06=F U=21=O' ☿☿	☾☿ ☿☿
-234.0.0.0.0	13Zip 4Ahau	31,200	78	Sat, 05Feb 95,370 BC	11,232,000		07=G T=20=O' ☿☿	
-221.0.0.0.0	13 Kayab 4Ahau	36,400	91	Wed, 16Jun 90,245 BC	13,104,000		08=H S=19=O' ☿☿	
-215.10.0.0.0	8Xul 4Ahau	41,600	97½	Fri, 21Feb 87,682 BC	14,040,000	Midpoint of 2nd Great Cycle of Northern Mountains from Arcturian Pachydermi	Second Age of Hyperborea	☾☿
-208.0.0.0.0	8Mac 4Ahau	44,200	104	Sun, 26Oct 85,120 BC	14,976,000		09=I R=18=O' ☿☿	
-195.0.0.0.0	3Chen 4Ahau	46,800	117	Thu, 08Mar 79,994 BC	16,848,000		10=J Q=17=O' /☿	
-182.0.0.0.0	18Zotz 4Ahau	52,000	130	Mon, 18Jul 74,869 BC	18,720,000	End of 2nd Great Cycle of Hyperborea Start of 3rd Great	11=K P=16=O' ☿☿	☾☿ ☿☿

Bermanseder, T., *The Physics of Morphogenetic Planetary Resurrection*

						Cycle of Lemuria		
-169.0.0.0.0	18 Cumku 4Ahau	57,200	143	Fri, 27Nov 69,744 BC	20,592,000		12=L O=15=O'	W9
-156.0.0.0.0	13Kan kin 4Ahau	62,400	156	Tue, 08Apr 64,618 BC	22,464,000		13=M N=14=O'	H9
-150.10.0.0.0	8Zip 4Ahau	65,000	162%	Thu, 13Dec 62,056 BC	23,400,000	Midpoint of 3rd Great Cycle of Southern Waters from Pleiadean Cetacini	Third Age of Lemuria	W9
-143.0.0.0.0	8Yax 4Ahau	67,600	169	Sat, 18Aug 59,493 BC	24,336,000		14=N M=13=9H	O'
-130.0.0.0.0	3Xul 4Ahau	72,800	182	Wed, 28Dec 54,368 BC	26,208,000		15=O L=12=9W	O'
-117.0.0.0.0	18Pop 4Ahau	78,000	195	Sun, 10May 49,242 BC	28,080,000	End of 3rd Great Cycle of Lemuria Start of 4th Great Cycle of Zep Tepi	16=P K=11=9E	O'
-104.0.0.0.0	18Muan 4Ahau	83,200	208	Thu, 18Sep 44,117 BC	29,952,000		17=Q J=10=9J	O'
-91.0.0.0.0	13Zac 4Ahau	88,400	221	Mon, 29Jan 38,991 BC	31,824,000		18=R I=09=9M	O'
-85.10.0.0.0	13Cumku 4Ahau	91,000	227%	Wed, 04Oct 36,429 BC	32,760,000	Midpoint of 4th Great Cycle of Eastern Fires from Andromedan Felini	Fourth Age of Zep Tepi	W9
-78.0.0.0.0	8Yaxin 4Ahau	93,600	234	Fri, 10Jun 33,866 BC	33,696,000		19=S H=08=9O	O'

Bermanseder, T., *The Physics of Morphogenetic Planetary Resurrection*

-65.0.0.0.0	3Zip 4Ahau	98,800	247	Tue, 19Oct 28,741 BC	35,568, 000		20=T G=07=9M O'	
-53.19.19.1 7.13	16Pax 10Ben	103,999 .98	259.99 995	Sat, 22Feb 23,615 BC	37,439, 993			
-52.0.0.0.0	3Kaya b 4Ahau	104,000	260	Sat, 01Mar 23,615 BC	37,440, 000	End of 4th Great Cycle of Zep Tepi Start of 5th Great Cycle of Atlantis	Aquarius of Joseph 21=U F=06=9-2 O'	W O M
-52.0.0.0.7	10Kay ab 11Man ik	104,000 .02	260.00 005	Sat, 08Mar 23,615 BC	37,440, 007		Aquarius of Joseph	W
-52.1.7.3.12	0Kanki n 7Eb	104,040 .8	260.10 2	Fri, 21Dec 23,589 BC 0x400=0 Civil Years CY	37,454, 688	Thuban Human Conception to Arcturian Human Embryo	Aquarius of Joseph Capricorn of Zebulon Sagittarius of Issachar	W C /
-39.0.0.0.0	18Ceh 4Ahau	109,200	273	Wed, 12Jul 18,490 BC	39,312, 000		Sagittarius of Issachar Ophiuchus of Hamid M, O, / Scorpio of Asher 22=V E=05=9@ O'	/ M
-36.6.0.7.4	12Cum ku 3Kan	110,534	276.33 5	Fri, 21Dec 17,189 BC 16x400=64 00 CY	39,792, 240	Arcturian Human Embryo to Pleiadean Human Larvae	Scorpio of Asher Libra of Naphtali	M Q
-26.0.0.0.0	13Mol 4Ahau	114,400	286	Sun, 20Nov 13,365 BC	41,184, 000		Libra of Naphtali Virgo of Gad	Q M

Bermanseder, T., *The Physics of Morphogenetic Planetary Resurrection*

							23=W D=04=9Π O'	
- 20.10.0.0.0	13Muan 4Ahau	117,000	292½	Tue, 27Jul 10,802 BC	42,120, 000	Midpoint of 5th Great Cycle of Western Winds from Sirian Canisi	Fifth Age of Atlantis Pharez-Leo- Zarah Manasseh of Ep hram Younger Dryas Comet Sphinx and Pyramids	⊗
- 20.10.13.1 0.16	19Zotz 12Cib	117,013 .6	292.53 4	Fri, 21Dec 10,789 BC 32x400=12, 800 CY	42,129, 792	Pleiadean Human Larvae to Sirian Human Pupa	Leo of Judah Cancer of Dan	⊗
-13.0.0.0.0	8Zotz 4Ahau	119,600	299	Thu, 01Apr 8239 BC	43,056, 000		Cancer of Dan Gemini of Levi δ/Θ/Π Arachne of Dinah 24=X C=03=9δ O'	⊗ Π δ
- 4.15.6.14.8	11Chen 8Lamat	123,520 .4	308.80 1	Fri, 21Dec 4389 BC 48x400=19, 200 CY	44,467, 344	Sirian Human Pupa to Thuban Starhuman Imago	Taurus of Simeon	δ
0.0.0.0.0	8Cumku 4Ahau	124,800	312	Mon, 11Aug 3114 BC	44,928, 000		Arachne of Dinah Taurus of Simeon 25=Y B=02=9Υ O'	δ
13.0.0.0.0	3Kankin 4Ahau	130,000	325	Fri, 21Dec 2012 64x400=25, 600 CY	46,800, 000	End of 5th Great Cycle of Atlantis Start of Starhumanity in Gestation	Aries of Reuben Pisces of Benjamin 26=Z A=01=9Ω AO'	δ Υ X Mo

Bermanseder, T., *The Physics of Morphogenetic Planetary Resurrection*

						as Human Imago	Baab ω Abba Omega Mother Father	
13.0.1.0.0	18Mac 13Aha u	01	1/400	Mon, 16Dec 2013	1-360		01=A Z=26=O' A Ω♀	☉♃ ♁
13.0.2.0.0	13Mac 9Aha u	02	1/200	Thu, 11Dec 2014	361-720		02=B Y=25=O' ♃♀	♃
13.0.3.0.0	8Mac 5Aha u	03	3/400	Sun, 06Dec 2015	721- 1080		03=C X=24=O' ♃♀	♃
13.0.4.0.0	3Mac 1Aha u	04	1/100	Wed, 30Nov 2016	1081- 1440		04=D W=23=O' ♃♀	♃
13.0.5.0.0	18Ceh 10Aha u	05	5/400	Sat, 25Nov 2017	1441- 1800		05=E V=22=O' ♃♀	♃
13.0.6.0.0	13Ceh 6Aha u	06	3/200	Tue, 20Nov 2018	1801- 2160		06=F U=21=O' ♃♀	♃
13.0.7.0.0	8Ceh 2Aha u	07	7/400	Fri, 15Nov 2019	2161- 2520		07=G T=20=O' ♃♀	♃
13.0.8.0.0	3Ceh 11Aha u	08	1/50	Mon, 09Nov 2020	2521- 2880		08=H S=19=O' ♃♀	♃
13.0.9.0.0	18Zac 7Aha u	09	9/400	Thu, 04Nov 2021	2881- 3240		09=I R=18=O' ♃ ♀	♃
13.0.10.0.0	13Zac 3Aha u	10	1/40	Sun, 30Oct 2022	3241- 3600		10=J Q=17=O' ♃ ♀	♃
13.0.11.0.0	8Zac 12Aha u	11	11/400	Wed, 25Oct 2023	3601- 3960		11=K P=16=O' ♃♀	♃
13.0.12.0.0	3Zac 8Aha u	12	3/100	Sat, 19Oct 2024	3961- 4320		12=L O=15=O' ♃♀	♃
13.0.13.0.0	18Yax 4Aha u	13	13/400	Tue, 14Oct 2025	4321- 4680		13=M N=14=O' ♃♀	♃
13.0.14.0.0	13Yax 13Aha u	14	7/200	Fri, 09Oct 2026	4681- 5040		14=N M=13=♀ ♃O'	♃
13.0.15.0.0	8Yax 9Aha u	15	3/80	Mon, 04Oct 2027	5041- 5400		15=O L=12=♀ ♃O'	♃
13.0.16.0.0	3Yax 5Aha u	16	1/25	Thu, 28Sep 2028	5401- 5760		16=P K=11=♀ ♃O'	♃





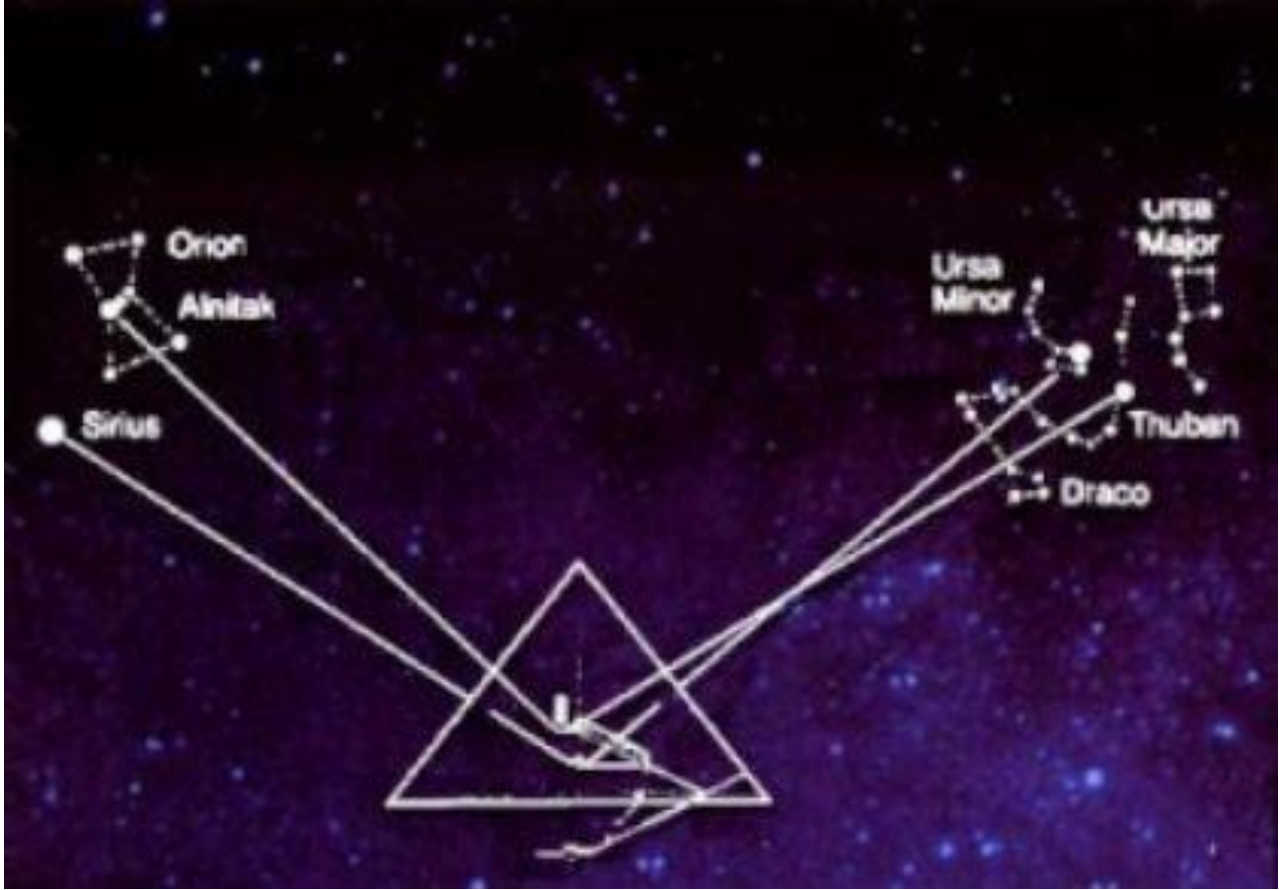

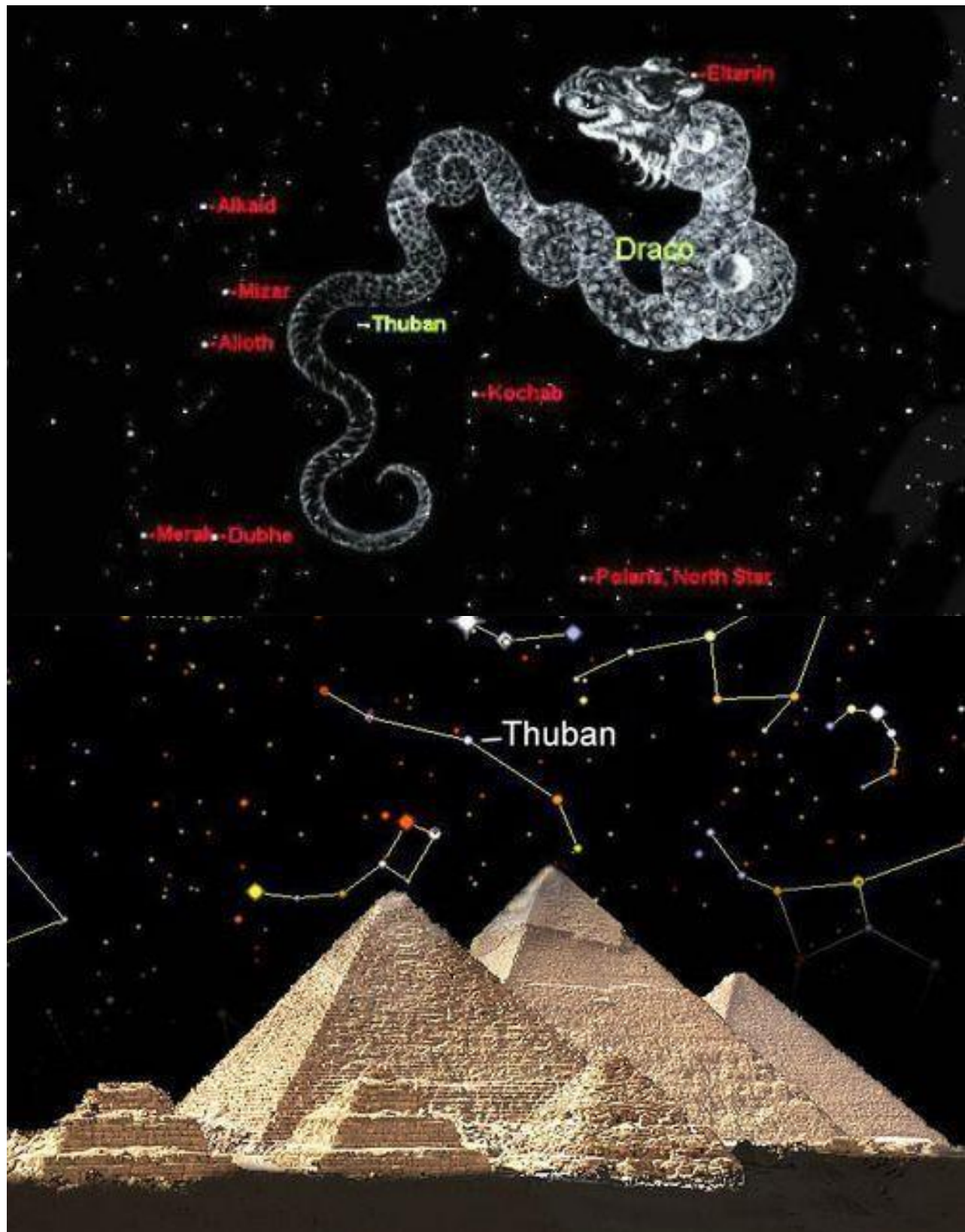



This treatise is a complement to the articles published on these and related links:

[https://www.academia.edu/39260931/Antigravity_in_Membrane-Space Time Encodings and the Mayan Calendar for a World in Transition](https://www.academia.edu/39260931/Antigravity_in_Membrane-Space_Time_Encodings_and_the_Mayan_Calendar_for_a_World_in_Transition)

[https://www.academia.edu/39277741/Radiation Mass and the Mind-Body WaveParticle Duality](https://www.academia.edu/39277741/Radiation_Mass_and_the_Mind-Body_WaveParticle_Duality)