

# God Reborn - The Birth of God as a Superbrane

A Story of Intelligent Design and the Creation of the Quantum Universe

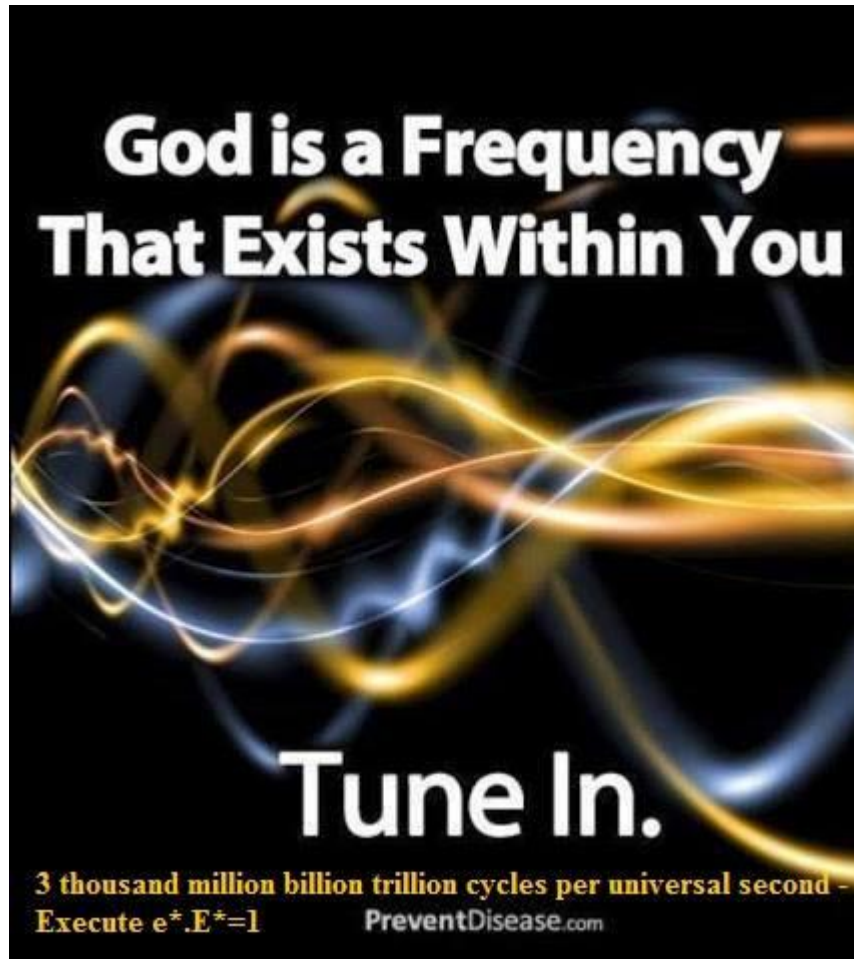

## Dirac's Magnetic Monopole and the Energy Density of the Universe from Dark Matter with Dark Energy

A Cosmology of Initial Boundary Conditions

The question of creation as quantum fluctuation ex nihilo is answered as a creation ex UniPhysCon as the quantum entanglement of omnispace in the form of universal physicalized consciousness.

## Dedication:

**DE MORTUIS NIL NISI BONUM**

**{Speak Nothing but Good of the Dead}**

**Out in the graveyard;  
inscriptions, words and plaques, all withering away;  
like the flowers adorning them, so the dead do lay.  
Waiting and waiting for someone to remember them  
and not just in photoalbums or on the special days.**

**Memorials are built, meaningless constructions - lest we forget!  
They all are forgotten, given time enough to sigh, to pass away.  
The living are so busy preparing for their own demise, to die.  
Little do they know, the busy ones, that the dead are still alive.**

**They watch over the living ones, they do, from a place so far;  
yet so near they are, but why would they watch the way they do?  
To understand the mystery is the noble thing to do - a gallant quest.  
They wish to be remembered, to join in soul and mind , the body's zest.**

**A marriage betwixt the dimensions, a holy union in heaven with hell.  
But can the fearful thoughts of the living see, their lovehearts tell?  
The living are like snowflakes, made of water, so unique one by one.  
But they melt away, to be fluid again - into the one great ocean, gone!**

**The dead are all one in the great seas, waiting to crystallise again in two.  
To wake up to a new life again, as a snowflake-twin, asking: 'Love me too!'  
Eternal life awaits the living, could they only reply to the dead's request.  
But the alive ones linger and doubt, in vanity do they live their only quest.**

**SIC TRANSIT GLORIA MUNDI**

**{Thus passes away the glory of the world}**

### *Revelation 14:13 -King James Version (KJV)*

*13 And I heard a voice from heaven saying unto me, Write, Blessed are the dead which die in the Lord from henceforth: Yea, saith the Spirit, that they may rest from their labours; and their works do follow them.*



To Beame  
Running Water  
Sirebard

## FUTURE SHADOWS OF THE PAST

**"A most wondrous thing the Shadow is, a redeemer in all to succor;  
it can go where the light cannot abide, seemingly banished, it is not.  
For where the light is, the darkness flees, no longer present to endure;  
so to become illuminated is its destined journey and its troubled lot.**

**But without the light, no Shadow can be cast, it's such a splendid key;  
the dimensions reduce in space from three to two and all in just the one.  
Betwixt the light and the darkness it is and part of both for all to see;  
the Shadow of the body, does it not merge all in its rule under the sun?**

**Whatsoever can cast a Shadow, must be a most wondrous thing to relay;  
as nature's very own offspring, the young ones grow towards their final goal.  
Enabled to bring peace to so many things appearing apart and so far away;  
the reconciliation for the suffering body with its spirit and its scattered soul."**

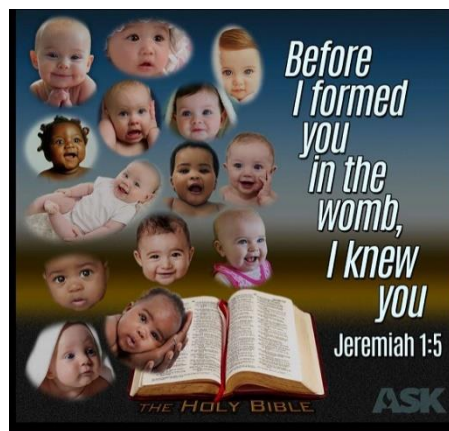

## **Foreword:**

A claim to have some answers to pertinent and profound questions in regards to the perennial quest of the human race to understand itself in being and in mind can be no statement of whimsicality.

Such a proposition demands a thorough investigation of the issues at hand; not a one-sided or biased examination of selected data and information; but a rigorous scientific approach to evaluate all the evidence supplied in the history of the developments, both in the popular culture and its science and the philosophies supporting it.

It is of limited value to parade the scientific discipline as the rational and impartial paradigm for the future; if that same worldview proves itself incapable to elucidate or to explain the most basic of elementary questions asked or problems faced by the now globalized citizen, placing hiser hope and expectation into that same projected future. And the overwhelming problem facing humanity at the beginning of the 21st century is that of its own philosophy.

‘Where are we now as a race?’, ‘Where are we going?’ and ‘Where did we come from?’ are some common questions asked, but not answered by the expert authorities in organized politics, science, culture, and religion. Why do we seem incapable, despite having built a monumental edifice called the scientific way and methodology; and notwithstanding the progressing technology derived from that; why then can that same worldview not answer a simple question like:

***“If there is such a thing as God, as so many of us have been told, then where and what is it?”***

We find an evolved human genetic disposition to form allegiances and to carry and ascribe to certain beliefs, often founded or exposted upon by certain individuals or groups. Kings and knights, magicians, clerics, and sages of old have transformed into the experts and advisors of the new.

Consultancy has become the catchphrase, often stifling the natural curiosity to find answers for one’s own questions in a denial of one’s own creative impulses through an adventure of self-discovery. Today, we find allegiances to political ideologies, religious dogmas, or some other culturally based agenda. All those liaisons and associations have something in common; however, they all become coloured in the individuals which belong to them. Redemption from this filtered state of affairs is found in a paradigm which is based on the precept of disallowing personality to individualize the work to be done or to colour the information to be collected as one’s personal archive or one’s private library of creation, subject to one’s own individual fancies and desires.

Albert Einstein once remarked:

***“The greatest trouble in the world is the idea of a personal God!”***

And so, one might agree with the de-personification of Albert Einstein’s ‘God,’ whom he rather affectionately called: ***“The Old One”*** and of whom he also said: ***“God does not play dice with the world,”*** referring to his rejection of the idea that life and nature’s processes are intrinsically arbitrary in a universe defined by chance and random events.

He thought of ‘God’ as being the intelligence behind the natural laws of nature, as found in the sciences and the mathematics which he studied and he believed that nature had to be based in geometrical principles, rather than in probabilities defined in statistics and stochastic matrices.

And there were others before and after him; Plato and Aristotle, upon whose dialogues this treatise is based; Pythagoras, the Greek geometers and Niels Bohr, Max Planck and Werner Heisenberg, all contemporaries of Albert Einstein with Paul Dirac, Max Born and Wolfgang Pauli in their contributions to the birth of quantum mechanics.

The symmetries in nature, numbers and sequences and fundamental constants; all seem finetuned and set into relationships with one another to create the universe and all the cosmological entities within it.

And one should not forget another genius of contemporary science in Isaac Newton. But what the modern world has tried to forget and to sequester away under an umbrella of a perceived historical ignorance, was the immense interest Isaac Newton, the father of all of classical mechanics, had in the concepts of religion. And what is the modern moral evaluation by his peers, judging a man whom they portray to the students of science as having had no equal in his time in regards to his scientific work, inventions and mathematical insights?

His power of pure intellect, like Einstein's, is often used to exemplify the necessity for logical thought and concentration in the pursuit of scientific and mathematical excellence by the students in those fields. Is it embarrassing to tell the full story; that Isaac Newton spent months at a time trying to decipher scrolls, like the 'Book of Daniel' and the 'Book of Revelation' in the bible?

***"He must have been deluded in the religious fervor of his age!"*** they would have said.

But was he?

Could a mathematical prodigy like Isaac Newton have been so gullible? Isn't it more likely, that he sensed that there was something to it – and that it had to be scientific?! Isaac Newton's 'God' is the same as Albert Einstein's 'God' and yet it is completely impersonal. It must be, by the definition of the working ethic!

But is it?

Could it be possible, that once the 'God of Science' has become impersonal, that then this same 'God' is reborn in a 'God of Omniscience,' who allows, even demands a personification, because of its own definition?

And what if that had been the masterplan throughout the ages anyway? Can we then ever know and understand such a masterplan?

And what if all the clerical authorities around the globe are forced by their own followers to take notice?

What if modern science can prove to them that their 'Allah' and 'Jehovah' and Yahwey and 'Brahma' and 'Baha' and 'Krishna' and 'Ra' and 'Osiris' and 'Set' and 'The Big Goat behind the Old Oaken Tree in the Walpurgisnacht on April 30th' are all one and the same as the 'Order out of Chaos!' defined in a Universal Logos or Universal Intelligence manifesting the Primordial Universal Consciousness as a Source Energy and a circumstance and phenomenology which could be called the 'Word of God' as its physical manifestation ?

What if their scriptures and ancient scrolls became illumined in a new light of omniscience; should their powerbase not become depersonalized if they are shown to have followed a very limited interpretation of their 'sacred texts' indeed?

Where would they go in their grandstanding of and about 'God's Law' for the 'chosen people' and for the 'infidels'? It would be the end of falsified religious dogma and the death of manipulative religion as such.

Because omniscience is Omni-Science, the Science of 'The All' for 'The All' and the German word for the cosmos or the universe is "Das ALL" - Albert Einstein and Max Planck and Werner Heisenberg and Wolfgang Pauli and Max Born would have liked that in their contemplations upon the natural order of things.

Albert Einstein also said: "**Science without Religion is lame and Religion without Science is blind**"- and this book shall try to synergize the two worldviews in a redefinition of Heisenberg's Uncertainty Principle and its statistical nature within a geometrical interpretation of quantum mechanics.

And then would peace between the nations have a chance, because of the demise of the old religions and the already internationally accepted profundity of the scientific way and methodology. Like music, dance or mathematics, a new language would sweep the old world of hate and dispossession, the ways of disempowerment and disbelief under the carpet of the illumination of a new base of knowledge.

A new song would be sung and the nations and tribes and families at war with each other could embrace one another in a new way of looking at the world around themselves and their individuated places within it. And all the many things they had learned from their history through the ages of humankind; all their legends, myths and fables, their religions, and sciences; all would become integrated within themselves in a renewed understanding and the death of their ignorance regarding themselves.

But to succeed, the initiation of this omniscience is first required to affect its own birthing process. The mathematical principles of necessity and sufficiency must be satisfied, and the scientific global community must become informed about the new dispensation. The premises of the new model also necessitate their scientific validation through experiment and verification in the collective scientific data base.

This then is the disclaimer for this play of words.

To scientifically empower the new dispensation; a scientifically rigorous approach in its elementary application cannot be avoided. Science cannot 'prove' something, without clearly identifying its parameters and boundary conditions.

There is an abundance of literature, which explains the present status quo in the specialized fields of particle physics, quantum theory, unification physics and cosmology in a populist genre of communication. Many discoveries add to that edifice on a daily basis.

This treatise then does not retell the stories, which have already been told in many other ways and media. A list of references points to supportive accounts of some popular ones amongst them. This essay attempts to explain the fundamentals, the principles, and preconditions for what brought about the universe's occurrence and the parameters which led to its definition in the natural laws.

And it is happenstance, that those precepts and prerequisites existing before space and time came into being, have a relevance for the birth of the religions of history or what one could term the 'spiritual impulse'. The bearing upon the personality is found to be a subset of a collective psyche; what one might perceive as the groupmind of a race or species; a somewhat very unique genus, which despite the relativity of the observer and the heliocentric reality – finds itself at the center of the universe, as itself – the race of mankind!

The ultimate aim of science to unify all aspects of existence so becomes a quest to enhance all energy and matter towards their most basic and elementary form of manifestation.

Once such a fundamental oneness is found and classified by science; then the scientific worldview will become enabled to cross-fertilize all its inter disciplinary factions and the global culture will be ready to purge itself from all unscientific and irrationally derived paradigms and belief systems.

That will be the death of superstition and of pseudoscience; the unscientific way of thinking and its many flawed perceptions in regard to observed natural phenomena.

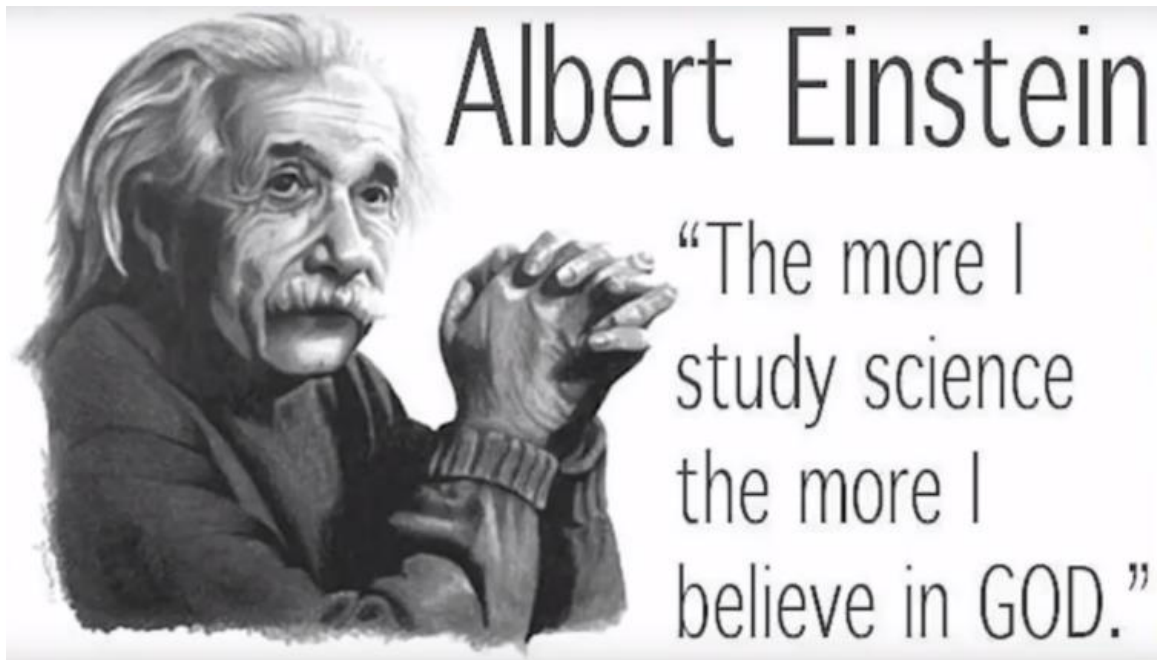

**4Q392:** "[...] and dominions [...] a man [...] God and not to turn aside from [...] and in His covenant your soul shall cling and [...] words of His mouth [...] and God [...] heaven above and to search out the ways of the sons of man, they have no hiding place. He created darkness and light for Himself, but in His dwelling place is the light of their light and all darkness rests before Him as well. He has no need to distinguish between light and darkness, but for the sons of man He distinguishes them as the light of day, with the sun, and night, with the moon and stars. He has a light which cannot be searched out, nor can its end be known. For all the works of God are doubled in this manner. We are flesh, which does not totally grasp these things. With us for [...] for a sign and wonders without number. [...] winds and lightning [...] servants of the holy of holies. They are as couches before him [...]".....translated by Martin G. Abegg, Jr.  
The Complete Dead Sea Scrolls; Geza Vermes; Penguin, London, 1997

**Isaiah 45:6-8 -King James Version**

<sup>6</sup> That they may know from the rising of the sun, and from the west, that there is none beside me. I am the LORD, and there is none else.

<sup>7</sup> I form the light, and create darkness: I make peace, and create evil: I the LORD do all these things.

<sup>8</sup> Drop down, ye heavens, from above, and let the skies pour down righteousness: let the earth open, and let them bring forth salvation, and let righteousness spring up together; I the LORD have created it.





<https://www.bitchute.com/video/mMVoAb4t9xtg/>

[Dirac's Magnetic Monopole And The Energy Density Of The Universe From Dark Matter With Dark Energy | Cosmogenesis - Library of Akbar Ra in Alexandria Thuban \(cosmosdawn.net\)](#)

## **Dirac's Magnetic Monopole and the Energy Density of the Universe from Dark Matter with Dark Energy A Cosmology of Initial Boundary Conditions**

### **Abstract:**

The Dirac quantization condition and its relationship to the electromagnetic fine structure constant  $\alpha$  is derived from the initial boundary conditions of the Quantum Big Bang Singularity (QBBS). The QBBS is shown to form a 2/11-dimensional mirror membrane as a 1-dimensional Dirac string relating timespace of a string-membrane epoch preceding the QBBS to the spacetime following the creation event. The Dirac monopole then transforms as a point particle into a space extended elementary particle known as the classical electron and is electro charge coupled as an electropole to the magneto charge of a magnetopole. The electron as a point particle of QFT and QED so becomes the monopolar form of the Dirac monopole as the Dirac electron but coupled to the elementary quantum geometric templates of the scalar Higgs boson with a dark matter particle defined as a RMP or Restmass-Photon.

This RMP is shown to couple in string-membrane duality to both a minimum sourcesink and a maximum sinksources expression in the energy distribution of the multi-dimensional universe. The ratio of the RMP's vibratory wormhole micro eigenstate of high energy to its winding mode anti-wormhole macro self-state then crystallizes the Planck-Density to Critical Density ratio in convolution with the dark energy and Zero-Point-Energy of the multi-dimensional cosmology.



For  $\{R_{RMP}(ss)/R_{RMP}(ps)\}^3=(f_{ss}/f_{ps})^2=(f_{ss})^4=(4\pi^2r_{ps}/r_{ss}c^2)^2 = \{1/81 \times 10^{120}\} \sim \text{Critical Density/Planck Density}$   
 $\rho_{\text{Planck}}/\rho_{\text{critical}}=\{2\pi c^5/hG_o^2\}/\{3H_o^2/8\pi G_o\}=\{16\pi^2c^5/3hG_oH_o^2\}=\{1.855079 \times 10^{96}\}/\{3.78782 \times 10^{-27}\} \sim 81 \times 10^{120}$   
 $= 4.897 \times 10^{122}$  in a de Sitter cyclically closed EMR 10D-cosmology for which  $\Omega=\Omega_B+\Omega_{MDM/RMP}+\Omega_{DE}=1$   
 $\rho_{\text{Planck}}/\rho_{\text{critical}}=\{2\pi c^5/hG_o^2\}/\{H_o^2/4\pi^2G_o\}=\{8\pi^3c^5/hG_oH_o^2\}=\{1.855079 \times 10^{96}\}/\{1.78497 \times 10^{-26}\} \sim 81 \times 10^{120}$   
 $= 1.039 \times 10^{122}$  in an Anti-de Sitter open-closed EMMR 11D-cosmology for which  $\Omega=\Omega_B+\Omega_{MDM/RMP}+\Omega_{DE}=1$

This is the universal sourcesink/sinksources volumar for the supermembrane Eps.Ess coupled in brane modular duality and solves the ‘cosmological constant’ problem in a revision of the Friedmann cosmology. In particular it is shown that the onset of the so termed dark energy at a redshift of  $z=0.6124$  simply relabels the dark matter made manifest from the QBBS given in higher redshifts in the form of the Einstein Lambda as an Einstein quintessence. By introducing a time evolving quintessence for the harmonic oscillator modal energy eigenstates  $|E_{ps}|=\Sigma\{\frac{1}{2}+N\}hf_{ps}$  for supermembrane Eps.Ess in the Zero-Point-Energy, the quantum description for spacetime crystallizes as a parameter space between maximized and minimized oscillation modes for the heterotic string class HE(8x8) as 10-dimensional expressions for the 11-dimensional membrane spacetime as the cosmological boundary mirroring an open ended Minkowski cyclically flat expanding cosmology in a closed de Sitter cosmology. The lower dimensional universe so becomes cyclically bounded within an infinitely expanding unbounded higher dimensional cosmology with the cyclicity of the gravitationally retarded de Sitter universe quantum tunneling in the cosmology of the multiverse. The evolving spacetime cosmology as a thermodynamic black body radiator is shown to derive from a transition period from the timespace of a 5-generational 10-dimensional string epoch into a 11-dimensional multiverse self-intersecting its lower dimensional precursor in a cosmological Lightpath both refracted and cyclically reflected in the instanton-inflaton parameters of the QBBS. The timespace to spacetime transition is shown to manifest in a false Higgs-Planck boson vacuum or HBPFV as a consequence of the natural physical laws defining the concept of temperature as a form of kinetic-potential energy related to the frequency eigenstates of the QBBS parameter space. The breaking of the supersymmetry in energy so becomes a consequence from the quantum energy parameters of the  $E=k_B T=hf=mc^2$  transitioning from timespace into spacetime in the central manifestation of the energy in the HBPFV as the instanton-inflaton of the QBBS.

A temperature gradient in the HBPFV so defines a deviation between the Einstein quintessence and the quantum self-states of the Goldstone bosons of the fundamental energy interactions. The background temperature of the Quantum Big Bang Singularity as the quintessence temperature  $T(\Lambda_E)$  is far in excess from the Weyl boson defining the quantum form  $E_{ps}=k_B T_{ps}$ . The inflaton therefore triggers the spacetime hyperspace expansion to attain temperature equilibrium between the multiplying and tachyonic hyper accelerating spacetime quanta given by the Weyl parameters with the Einstein quintessence in the inflaton. This homeostasis is reached in the bosonic temperature unification so 2 nanoseconds from the time instantaneity of the QBBS. At the end of the inflation epoch the imaged QBBS manifests a midpoint for the gravitationally retarded thermodynamic expansion of the lower dimensional cosmology as a Lightpath of a higher dimensional ‘Electromagnetic Return’ to meet the decelerating universe for the onset of dark energy at redshift  $z=0.6124$ .

The Einstein quintessence therefore assumes particular cosmological characteristics manifesting both properties of a gravitationally decelerating cosmology in 10D and a Lightspeed invariant cosmology in 11D reflecting and refracting the 11D Lightpath emitted from the QBBS for the crucial time of having reached the spacetime boundary made manifest by the inflaton at the QBBS of the instanton.

A synthesis of the MOND cosmology of Milgröm with the LCMD standard model is shown to resolve itself not in modifying Newtonian gravitation, but in the Milgröm characteristic acceleration inherent as the cosmological constant of the Einstein quintessence as a QBBS parameter. The necessity for Dark Matter to harmonize the hypermass evolution remains however, with the Dark Energy itself assuming the form of the Milgröm deceleration. That the Dark Energy DE is negative pressure interacting with a sign changing Einstein quintessence is also pointed out as a cosmological effect by Erik Verlinde in his 'Emergent Gravity' model in associating the Milgröm deceleration with the Hubble Constant and therefore the Friedmann standard cosmology by  $GM/R^2 < cH = -2cH_0/(n+1)^3$

The space occupying classical electron as a Dirac string derivative is shown to oscillate on the Fermi scale of the nuclear interactions of colour charge asymptotic gluon-quark confinement, with the ground state for the electron defining the wormhole singularity of the QBBS in spacetime as the fifth transformation of superstring classes (heterotic class 64) from the timespace era. The Dirac string so manifests as a membrane-mirror for a 4-dimensional spacetime embedded within a 5-dimensional spacetime and descriptive for a 3-dimensional surface embedded as volumar within a higher dimensional cosmology, described in the properties of a Möbian-Klein Bottle geometric connectivity for a one-sided manifold becoming two-sided in the original form of the Dirac string as a one-dimensional mathematical singularity mirroring itself in the monopolar string self-duality of a multidimensional holographic cosmology .

The natural stability of the proton and the absence of an original supersymmetry between matter and antimatter is shown to be the result of the non-existence of antimatter in the primordial universe and the coupling of the Higgs boson to the RMP of spin -1 and energy 14.03 TeV\*. Primordial neutron decay becomes the transformation of a RMP boson in the form of an ylemic dineutron into two lefthanded neutrons quantum spin coupled to a graviphoton as the scalar Higgs bosonic blueprint of the wave-quarkian quantum geometry. Particular initial boundary conditions for the QBBS, defined as the Dirac magnetic monopole indicate the energy regime for the Higgs Boson as being bounded in a subatomic displacement scale from 0.000014-0.0028 fermi. This displacement scale forms a natural boundary for the mesonic scale for the strong nuclear interaction and resolves the discrepancy in the mean lifetime for beta minus decay in showing that the excess of neutrons at the Higgs energy with RMP-dark matter excess is  $126.95/125.78=1.0093$  and becomes balanced by a deficit of neutrons at the Higgs energy with RMP -dark matter deficit in  $122.49/123.57=0.9913$  and time differences of 10.28 and 9.92 seconds\* for a mean neutron lifetime of 880.14 s\* respectively.

The thermodynamic evolution of the universe is shown to relate a general evolution of neutron stars with specific nuclear densities with respect to the cosmic radiation background to the Hawking properties of black holes as a background energy matrix originating from the distribution of a baryonic mass seedling and its coupling to the QBBS parameters. The Hawking-Gamow Temperature Unification for classical and quantum gravitation is so derived as the temperature ratio:

$$T_{\text{Hawking}}/T_{\text{ylem}} = hcR_e^3/2\pi G_0 m_c^2 R_{\text{ylem}}^2 R_{\text{Hawking}} = R_e^3/\alpha_{\text{nucleon}} \cdot R_{\text{ylem}}^2 R_{\text{Hawking}} \text{ with } \alpha_{\text{nucleon}} = \alpha_{\text{planck}} \alpha_e^{18} .$$

Hawking's micro black holes are shown to play a decisive role in the universal cosmology, as they modulate the quantum gravitational universe of the creation event with the classical gravitation of the spacetime geometry. In particular the micro black holes form the energy centers within encompassing vortices of potential energy modelled on the Jeans length applied to the general temperature evolution of the universe and inclusive of dark matter haloes around galaxies deriving from the original intersection of the higher dimensional inflaton superluminal light path with the lower dimensional light path of the instanton. Hawking's Information Paradox is resolved in the DE onset as the Page Time.

The HBPFFV so manifests electroweak unification at the intersection coordinate between the expanding ylemic Dark Energy/Dark Matter-RMP Halo and expanding CBBR gravitationally retarded cosmology and described in the Hawking-Gamow modulus  $HGM = M_{\text{Hawking}} T_{\text{ylem}} = hc^3/4\pi k_B G_0 = M_{\text{curv}} T_{\text{Hawking}}$

The difficulties in measuring Newton’s gravitational constant are found to be causally related to the measured variation in the electromagnetic finestructure constant  $\alpha_e$  as the polar orientation of the Dirac string of the QBBS and as a distribution of t’ Hooft-Polyakov monopoles in the Schwarzschild metric at the GUT unification energy scale from  $2.7 \times 10^{16}$  GeV\* to  $8.1 \times 10^{17}$  GeV\*.

The supersymmetry and coupling parameters of the superstring classes is shown to derive from the interaction of the Planck-Stoney finestructures.

The classical electron parameters are shown to relate to the electron of Quantum-Field-Theory QFT in a reassigning of the electromagnetic mass in a distribution of electron velocities in the wave matter of de Broglie and the Compton constant  $m_e R_e = \text{Compton constant} = \alpha h/2\pi c = l_{\text{planck}} \cdot \alpha \cdot m_{\text{planck}} = m_{\text{ec}} r_{\text{ec}}$ , which proportionalises the quantum relativistic size of the electron with its mass. The classical electron is reborn within the structure of QFT in attaining a monopolar nature, derived from the Dirac string as a Dirac electropole.

The concept of ‘Universal Physicalized Consciousness’ or UPC is defined from the conformal mapping of the magneto charge from timespace onto the electro charge in spacetime utilizing the dimensional reduction from 11D membrane spacetime into 10D string spacetime in the modular- and mirror duality of the {10-11-12} D spacetime matrix. UPC becomes identical in dimensional analysis to the gravitational parameter GM in its frequency quantum eigenstate and so defines a quantum radius-independent angular acceleration acting on any volumar constituent within any spacetime occupancy. In this capacity, the UPC defines the Einstein quintessence and so resolves the Dark Matter – Dark Energy distribution in the nature of the quintessence as a spacetime inherent classical acceleration, yet as a function of a nodal Hubble parameter, described as a frequency equivalent and coupling to the Weyl-wormhole frequency of the QBBS in  $f_{\text{ps}} \cdot \lambda_{\text{ps}} = f_{\text{Weyl}} \cdot \lambda_{\text{Weyl}} = c = H_0 \cdot R_{\text{Hubble}}$ .

I: Introduction to a Multidimensional Relaxation Cosmology for a ‘Hubble Tension’ in Quantum Relativity with Hawking’s Information Paradox Resolution.....(12-44)

II: Foreword – Dirac’s String-Monopole Transformation.....(45-46)

III: The Creation of Dirac’s Quantum Big Bang in Spacetime from Timespace.....(47-66)

IV: The Dark Energy coupled to the Light Energy of a Shadow-Mirror Universe.....(67-81)

V: The Higgs-Planck False Vacuum and the Temperature Gradient for the QBBS Cosmology.....(82-97)

VI: The Ylemic Universe and Quantum Gravitation from Superbrane Parameters.....(98-123)

VII: A Synthesis of  $\Lambda$ CDM with MOND in a Universal Lambda Milgröm Deceleration.....(124-136)

VIII: A Revision of the Friedmann Cosmology and Emergent Gravity in a Hypermass Multiverse.....(137-178)

IX: Ylemic Gluon-Quark-Plasma Protostars as Vortex QBBS Energies.....(179-198)

X: Primordial Neutron Decay from Higgs Boson – RMP/DM Quantum Geometry.....(199-202)

XI: Initial Boundary Conditions for Matter-Antimatter Asymmetry.....(203-222)

XII: The Gravitational Constant, the Alpha Finestructure Constant and the GUT-Monopole.....(223-234)

XIII: The Inflaton and the Grand Unification Symmetry in a Transformation of Supermembranes.....(235-265)

XIV: The Quantum Relativistic Monopolar Electron.....(266-314)

XV: The Birth of the Universe in Space and Time from Physicalized Universal Consciousness.....(315-343)

XVI: Quantum Consciousness in the Penrose-Hameroff Model.....(344-353)

XVII: Epilogue: God Reborn - The Birth of God as a Superbrane - A Story of Intelligent Design and the Creation of the Quantum Universe in the Uniphyscon of Quantum Entangled Omnispace.....(354-366)

# I: Introduction to a Multidimensional Relaxation Cosmology for a ‘Hubble Tension’ in Quantum Relativity with Hawking’s Information Paradox Resolution

The cosmological measurements for an accelerating expansion of the universe and as a consequence of Hubble’s law for the Hubble parameter  $H(n,t) = \text{Recessional Velocity } v(n,t)/\text{Cosmological Displacement } R(n,t)$  are the result of a multidimensional cosmology.

There is not one Hubble parameter, but there are three Hubble parameters, defining various interwoven aspects of the multidimensional cosmology in a compacted event horizon in the lower form and bounded by a nodal form and a true event horizon with an unbounded particle event horizon, both in the higher form.

The lower dimensional expansion of a closed de Sitter dS universe is bounded by a nodal Hubble parameter  $H_0=c/R_H$  in a spacetime under gravitational retardation to define a constant Hubble event curvature horizon  $R_H=2G_0M_H/c^2$ . This nodal Hubble event horizon forms the higher dimensional boundary for a compacted event horizon moving towards it in the expansion of the universe. This compacted Hubble bound is different from a not compressed Hubble bound in not accounting for a dark matter sector in the multidimensional and therefore interwoven spacetime cosmology.

The multidimensional cosmology is modeled on the premises and stipulates of Quantum Relativity and a model combining the spacetime geometry of classical physics and cosmology with a model of quantum geometry, based on the concepts of string-membrane modular duality. The macro-state of classical gravitation as the curvature of spacetime is therefore related to quantum gravitation in a blending of the cosmological and astrophysical universe with the micro-states of quantum mechanics.

This introduction predicts two distinct, yet related values for the Hubble parameter and shows how those values are related.

For the dark matter inclusive cosmology, the Hubble parameter is defined in a true Hubble node, which oscillates in the lower dimension, but linearly decreases with the expansion of the universe in the higher dimension.

Experimental measurements for this Hubble parameter therefore will conflict between the oscillating and the linear form. Astronomical observations into ‘deep space’ or ‘back in time’ for an increasing cosmological redshift and the Cosmic-Microwave-Radiation-Background CMRB so will determine the linear Hubble parameter and as applicable in the addition of the dark matter region of spacetime.

**Quantum relativity predicts this dark matter inclusive value for  $H_0(n=H_0t) = 58.04 \text{ km/Mpc.s}$  to be:**

$$H(n,t) |_{\text{AdS}} = H(n_{\text{pAdS}}) = H_0/(2-n_{\text{present}}) = H_0/0.867288 = 2.165057 \times 10^{-18} \text{ [1/s]}^* \text{ or } 66.92 \text{ km/Mpc.s}$$

For the dark matter exclusive cosmology, the Hubble parameter is found in relating the compressed spacetime expansion to the oscillating form of the ratio of the recessional velocity to the compressed Hubble event horizon as the expanding wavefront modelled as the boundary of the universe. Astronomical measurements in the compressed spacetime so can be interpreted as observing cosmological distance scales as being closer to the observer than they actually are in the dark matter inclusive universe described as an Anti de Sitter AdS and open universe.

**Quantum relativity predicts this dark matter exclusive value for  $H_0(n=H_0t) = 58.04 \text{ km/Mpc.s}$  to be:**

$$H(n,t) |_{\text{dS}} = H(n_{\text{pdS}}) = H_0[n_p+1]^2/n_p(2n_p+1) = 1.22972H_0 = 2.309075 \times 10^{-18} \text{ [1/s]}^* \text{ or } 71.37 \text{ km/Mpc.s}$$

Differentiating the Hubble parameters in the addition of the dark matter sector relative to the baryon normal matter compressed spacetime so resolves the 'Hubble tension' as the statistically significant discrepancy between the measurements of the Hubble parameter in the CMRB measurements and distance scale related observations for the compressed spacetime of an interwoven interdimensional cosmology.

Measuring the Hubble parameter within the compressed dS spacetime so will result in values greater than the value at the lower dimensional Hubble boundary. Those measurements will converge as a mean value relative to the compressed boundary value at a n-cycle coordinate of  $n=1/2$  for the onset of the dark energy epoch in the multidimensional cosmology.

Values for the 'Hubble tension' for cosmological distance scales such as cepheid variable stars so will converge to such a value range for the more proximate universe.

**Quantum relativity predicts this dark matter exclusive value for  $H_0(n=H_0t) = 58.04 \text{ km/Mpc.s}$  to be:**

**$H(n,t)|_{dSDE} = H(n=1/2) = H_0/[1/2][1+1/2] = 4H_0/3 = 1.33333H_0 = 2.5036374 \times 10^{-18} [1/s]^*$  or  $77.39 \text{ km/Mpc.s}$  for a mean value of  $(71.37+77.39)/2 = 74.39 \text{ km/Mpc.s}$**

The nodal Hubble boundary emerged from an instanton-inflaton Quantum-Big Bang-Singularity QBBS and from a parameter space of initial and boundary conditions established from a Planckian pre-spacetime string-membrane epoch modelled on an algorithmic timespace transforming into a spacetime in the emergence of dimensional degrees of freedom to manifest the physical parameters in energy from a pre-physical or metaphysical quantized energy continuum labelled as universal consciousness from algorithmic timespace.

This de Sitter dS universe of positive curvature is modelled as a thermodynamic Planck Black Body Radiator expansion of a flat Minkowski spacetime experiencing the gravitational interaction in both the classical laws of General Relativity and the effects of quantum gravity from a higher dimensional parallel cosmology described as a Anti de Sitter AdS universe of negative curvature without gravitational retardation.

The interdimensional interaction between the closed dS and the open AdS universes results in a flat overall spacetime relative to a spacetime observer situated at an arbitrary central observation point, say the center of a geometric horn torus, encompassed by a sphere.

The AdS cosmology of lightspeed invariance at the QBBS then naturally expands the higher dimensional universe, say as a 5D Kaluza-Klein or an 8D Penrose or a 11D Witten spacetime at a greater rate than the gravitational Einstein-Planck-Minkowski in 4D EPM spacetime.

At some point in the universe's expansion the AdS Lightpath superposed onto the dS gravitationally retarded Lightpath will reach the nodal Hubble boundary and then both reflect and refract to expand the original size of the spacetime set by the initial boundary conditions of the instanton-inflaton defined QBBS. The higher dimensional Lightpath is denoted as EMMR for Electromagnetic Monopolar Radiation and the lower dimensional concurrent Lightpath is denoted as EMR for Electromagnetic Radiation.

The refracted Lightpath of the AdS universe then resets the nodal Hubble event horizon in a new boundary independent from the original instanton-inflaton parameters of the QBBS to define a true Hubble event horizon as a new boundary for the compacted Hubble event horizon to approach.

The reflected Lightpath from the old Hubble nodal event horizon  $H_0$  manifests a cyclic cosmology for the lower dimensional dS universe, however. The QBBS is mirrored at the even Hubble node  $H_0$  in the reflected Lightpath in an odd and even frequency count for the Hubble parameter with a clearly defined maximum at the QBBS as an even n-cycle count and a clearly defined minimum as  $H_0$  as an odd n-cycle count.

All cosmologies can so be defined in a n-cycle time parameter and where  $n=H_0 t$  with  $dn/dt=H_0$  as a true Hubble constant.

The compacted Hubble event horizon so becomes defined in the dS gravitationally retarded cosmology as the size of the lower dimensional curvature radius subject to an oscillating higher dimensional AdS Lightpath superimposed onto the expansion of the thermodynamic universe.

The true Hubble event horizon can be expressed in the refracted Lightpath as  $R_{EMMR}(n,t) = nR_H$  and the compacted Hubble event horizon becomes the curvature radius of the EPM protoveral universe as  $R_{EMR}(n,t) = R(n,t) = R_H n / [n+1]$  and bounded in  $H_0 = c/R_H$  as a 'Mother Black Hole MBH' as a 'Strominger eternal MBH brane' and in the Schwarzschild metric  $R_H = 2G_0 M_{oH} / c^2$  with  $G_0$  the gravitational constant as applicable to the Strominger BH evolution as 'eternal black holes'.

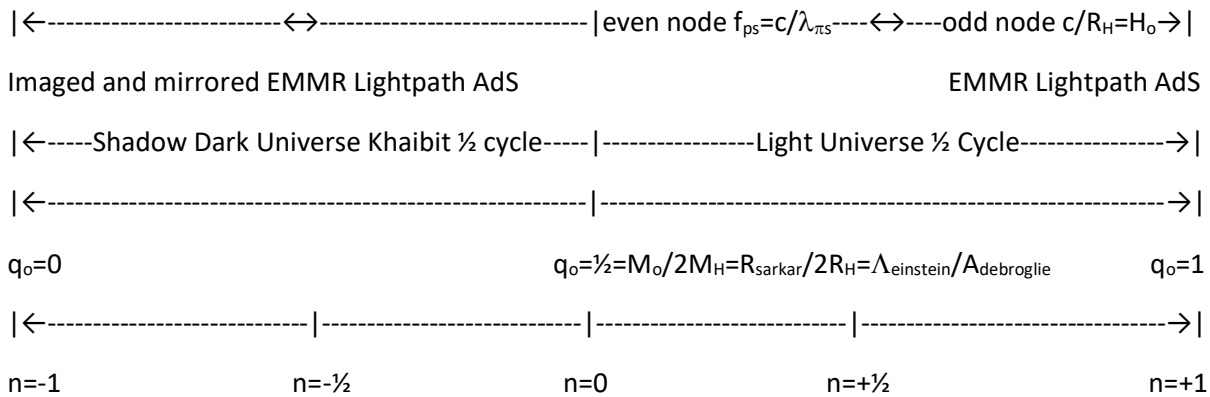

$q_0$  is a deceleration parameter defining the QBBS boundary initial parameters in the Einstein quintessence  $\Lambda_{\text{einstein}}$  and the de Broglie hyperspace inflaton hyper acceleration  $A_{\text{debroglie}}$  for the EMMR Lightpath as the ratio of the matter distribution  $\Omega_0 = M_0 / M_H$  for the overall energy density in the multidimensional cosmology.  $M_0$  is the mass seedling for the de Sitter protoverse defining a 'Sarkar Daughter Black Hole' in the Sarkar curvature radius  $R_{\text{sarkar}} = 2G_0 M_0 / c^2$  for the encompassing mass Strominger BH evolution engaging the Dark Matter and Dark Energy conditions.

Another deceleration parameter is defined in  $q(n) = -\{(d^2 a / dt^2)(a) / (da/dt)^2\}$  for scale factor  $a = R(n,t) / R_H$

The Lightpath for both EMMR AdS and EMR dS is coupled in the QBBS boundary parameters

$$f_{ps} \lambda_{ps} = f_{weyl} \lambda_{weyl} = f_{QBBS} \lambda_{QBBS} = c = H_0 R_H \text{ for the nodes of the spacetime mirrors.}$$

The recessional velocity from the Hubble law  $H(n,t) = v_{\text{rec}}(n,t) / R(n,t)$  for the dS Lightpath becomes

$$v_{\text{rec}}(n,t) = d(R(n,t)/dt = R_H d(n/[n+1])/dt = R_H (dn/dt) / [n+1]^2 = c / [n+1]^2$$

The recessional Lightspeed  $c$  velocity for the AdS cosmology so precedes the continuously slowing down  $v_{rec}(n,t)$  in dS as the refractive Lightpath with respect to the true Hubble event horizon and due to the gravitational retardation of the compacted Lightpath in the dS EPM universe.

The reflected form for this recessional velocity  $c$  then creates the appearance of an accelerating universe because the true recessional velocity in AdS is mirrored onto a previously defined coordinate of the recessional velocity of AdS in dS spacetime and when the AdS Lightpath reached this  $n$ -cycle coordinate in its forward journey to the true Hubble event horizon albeit within the nodal boundary of then both for the EMMR and the EMR Lightpath parallel.

The actual Hubble parameter so is defined for the curvature radius in the compressed de Sitter spacetime as:  
 $v_{rec}(n, t)/R(n,t) = \{c/[n+1]^2\}\{[n+1]/nR_H\} = H_0/n[n+1] = H_0/T(n)$

The time derivative for the actual Hubble parameter is  $dH/dt=(dH/dn)(dn/dt) = -H_0^2(2n+1)/T(n)^2$

The acceleration for the expanding curvature radius becomes the Milgröm acceleration  $a_{mil}$  invoked to explain the dark matter factor in Milgröm's Modified-Newtonian-Dynamics or MOND model and in Verlinde's Emergent Gravity from Quantum Information models.

$$a_{mil} = d(c/[n+1]^2)/dt = -2cH_0/[n+1]^3 = -2c^2/R_H[n+1]^3 \text{ [m/s}^2\text{)]*}$$

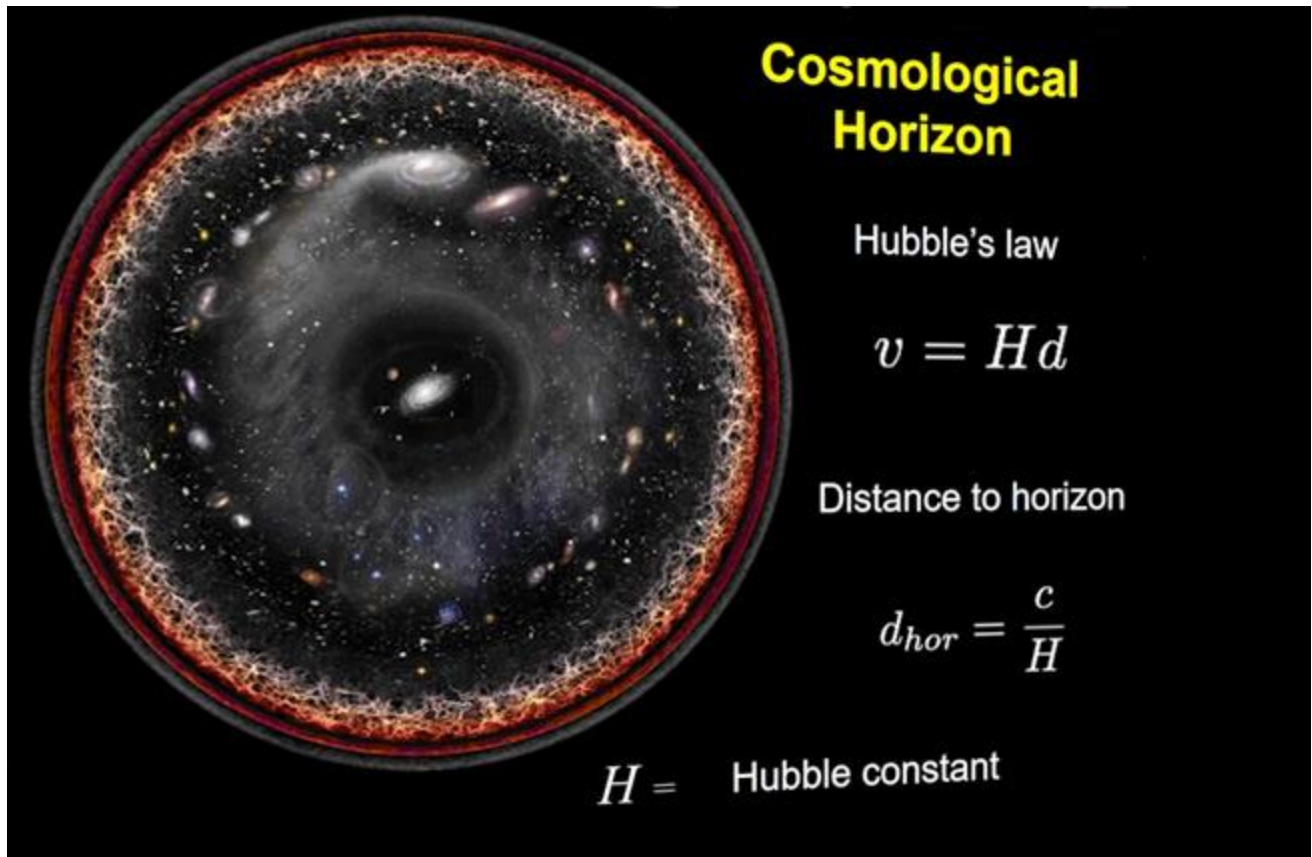

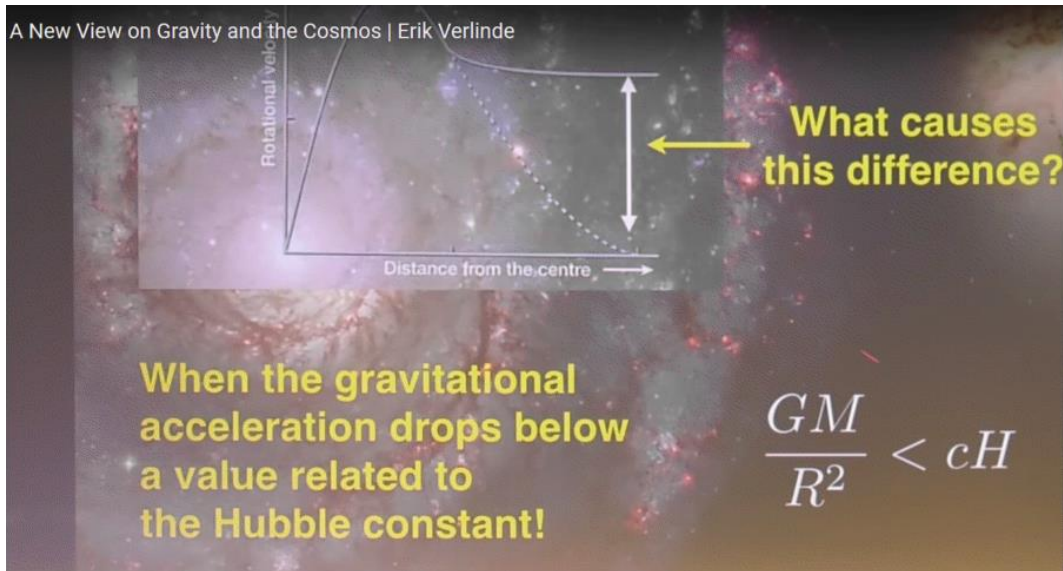

The deviation in the rotation speed of stars and massive astrophysical objects of galactic rotation curves from Newtonian-Keplerian gravitation is a consequence of the onset of the dark energy at the fractally synchronized Page Time nexus for the maximum quantum entanglement entropy state for a dark matter evolving galaxy in the multidimensional cosmology for the cycle time interval  $n \in [0.489365, 0.5]$ .

$2G_oM/R^2 < 2cH_o/[n+1]^3 = 2c^2/R_H[n+1]^3$  for galactic extremal Strominger black hole hyperspace equivalent  $2G_oM/c^2 = R_{curv} < 2R^2/R_H[n+1]^3$  m for Page Time maximum DE entropy  $n = \frac{1}{2}$  superposed on nodal  $n=1$

The curvature radius of the Strominger BH at Page Time is smaller than twice the extremal BH radius of closure for the intersecting  $n$ -cycle time intervals  $[-1, -\frac{1}{2}, -0.489365]$  with  $[-\frac{1}{2}, +\frac{1}{2}]$  with  $[0.489365, \frac{1}{2}, 1]$

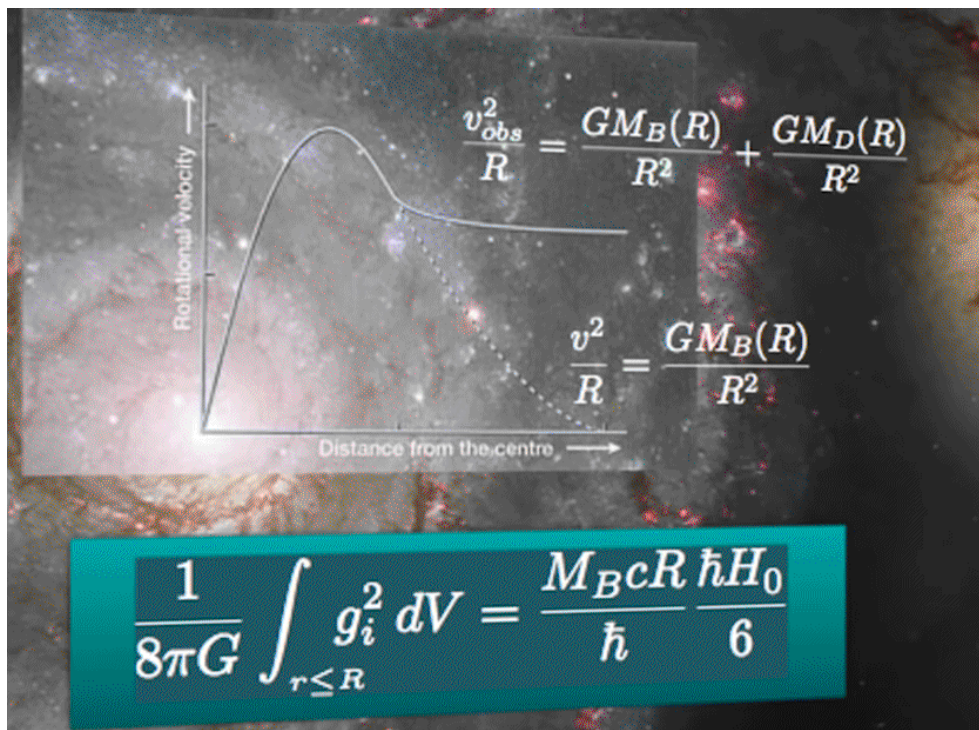



$$c^2 \rho_{\text{critical}} dV = c^2 dm = c^2 m_0 \{ (1 - [v/c]^2)^{-\frac{1}{2}} - 1 \} = c^2 m_0 \{ 1 + \frac{1}{2} [v/c]^2 - 3[v/c]^4/8 + 5[v/c]^6/16 - \dots - 1 \} = \frac{1}{2} m_0 v^2 - 3v^4/8c^2 \dots$$

$$c^2 \cdot 3H_0^2/8\pi G_0 \cdot dV = \frac{1}{2} M_{\text{BC}} R c/R_H = \frac{1}{2} M_{\text{BC}} c^2 R/R_H \text{ for } (1/8\pi G_0) (H_0 c)^2 \cdot dV = (1/8\pi G_0) (g_i)^2 \cdot dV = \frac{1}{2} M_{\text{BC}} H_0 R$$

A New View on Gravity and the Cosmos | Erik Verlinde

$$T = \frac{1}{2\pi} \frac{\hbar g}{k_B c}$$

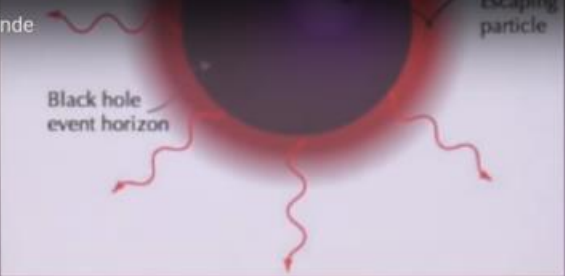

Black hole event horizon  
Escaping particle

$$g = \frac{GM}{R^2}$$

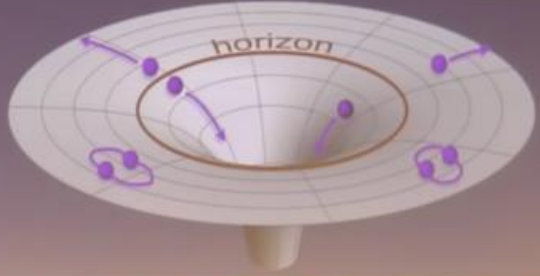

horizon

### The Great Black Hole Information Escape

As black holes radiate, information appears to be lost. But this can be avoided if the “entanglement entropy” of the radiation rises then falls. Recent calculations have shown how this happens via a “quantum extremal surface” that appears just inside the black hole’s event horizon. Everything inside of this surface is suddenly not part of the black hole. Exactly how this happens, and what it all means, is still an enormous mystery.

- 1** Black holes radiate by forming entangled particle pairs. One particle flies out, the other in.
- 2** As the number of entangled particle pairs grows, so does the entanglement entropy.
- 3** A quantum extremal surface appears just inside the horizon, making the black hole into something like a shell.
- 4** The innermost particles are no longer part of the black hole. Their entanglement no longer counts toward the entropy.
- 5** As the black hole radiates the last of its energy, the total entanglement entropy drops to zero.

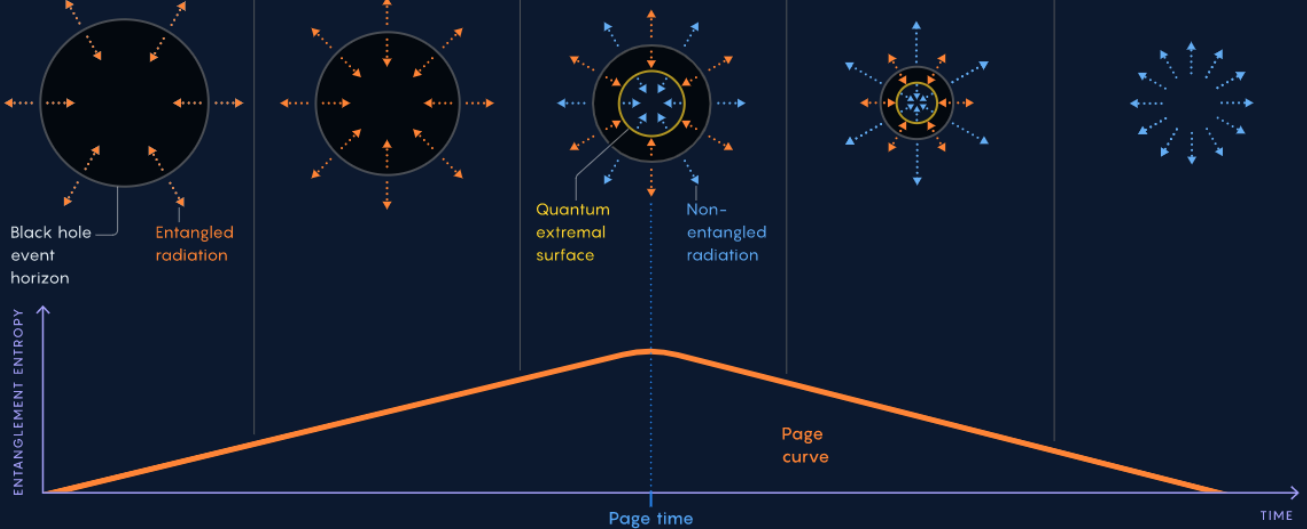

ENTANGLEMENT ENTROPY vs. TIME  
Page curve

The EMMR 'deja vu' returning Lightpath so will intersect the EMR Lightpath of the expanding de Sitter universe moving towards the Hubble node  $H_0$  at a  $n$ -coordinate  $n_{BMUDM}$  to define the baryonic matter BM expansion of mass seedling  $M_0$  meeting the dark matter DM, as the AdS part of the spacetime into which the dS spacetime expands into.

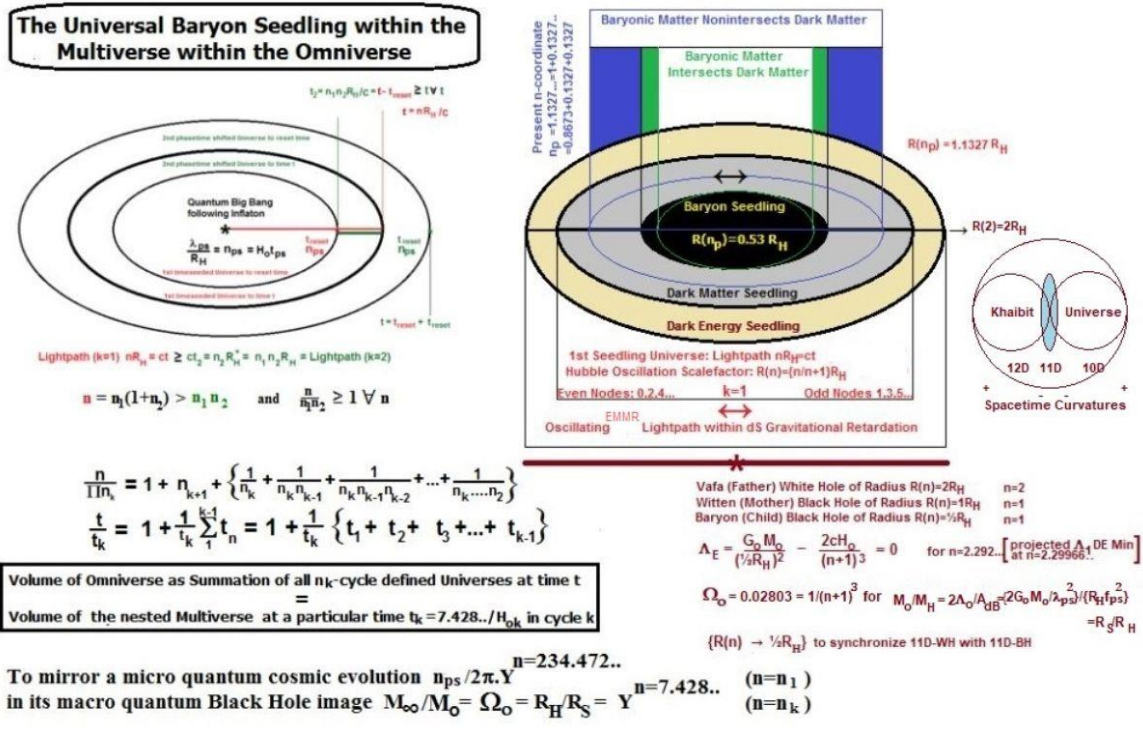

Using the  $R_{EMR}(n,t) \cup R_{EMMR}(N,t)$  definitions in the asymptotically expanding de Sitter cosmology for this coordinate:

$nR_H/c[n+1] = (2-n)R_H/c$  for  $n = (2-n)(n+1)$  for  $n^2 = 2$  and the coordinate  $n_{BMUDM} = \sqrt{2} = 1.414$  for dark matter saturation after the returning higher dimensional Lightpath has covered 0.414 or 41.4% of its forward journey in its 'dèjà vu' electromagnetic return.

For the present cycle time for  $n_{present}=1.132712$  then, the true Hubble event horizon in AdS defines a true Hubble event horizon  $c/H_{present} = nR_H$  and a compacted Hubble event horizon in dS spacetime as  $n_1 R_H/[n_1+1]$  superimposed onto the reflected image of the true Hubble event horizon with a recessional velocity deficit  $v_{rec(1)} - v_{rec(2)} = c/[n_1+1]^2 - c/[n_2+1]^2$  for  $v_{rec(1)}$  applicable to the compacted dS universe and  $v_{rec(2)}$  the value for the reflected velocity of the AdS Lightpath revisiting a previously encountered coordinate.

The 'electromagnetic return' of the EMMR Lightpath is given by the measurement of the cyclic Hubble parameter between the minimum odd and maximum even frequency nodes and for the present time the first half cycle completion and mirrored in the shadow half cycle completion has resulted in a full cycle completion for the coupled multiverse cosmology with an excess delta or difference of

$\Delta n = 1.132712 - 1 = 0.132712.$

The refracted Lightpath  $R_H(n-1)$  then defines the compacted and dS measured value for the Hubble parameter as  $H(n_{\text{present}}) = H_0/(2-n_{\text{present}}) = H_0/0.867288$  for the completion of the first full cycle in the second cycle of the multiverse.

The Particle Hubble event horizon  $R_P(n) = T(n)R_H = n(n+1) R_H$  as the n-cycle time defined extent of the AdS lightspeed invariant multiverse. For the present time it calculates as 40.76 billion lightyears.

A particular unifying n-cycle coordinate is found in the compressed de Sitter spacetime for which the scale factor  $a = R(n)/R_H = n/[n+1] = X = Y - 1$  and so for  $n = X/(1-X) = (Y-1)/(2-Y)$  defines the value of the nodal Hubble constant  $H_0 = c/R_H$  as the Hubble parameter  $H(n=X) = H_0/T(n=X)$  and so for the function  $T(X) = X(X+1) = X^2+X = n^2+n = n(n+1)$  with  $X^2 = 1 - X$  for  $T(n)=1$

A relationship between X and Y is defined in the Euler identity:

$$\exp[i\pi] = X+Y = XY = i^2 = -1 = \cos\pi + i\sin\pi \text{ for the roots of } T(n)=1 \text{ in } X=\pm\frac{1}{2}\{\sqrt{5} - 1\} \text{ and } Y=\pm\frac{1}{2}\{\sqrt{5} + 1\}$$

$$H(X=\frac{1}{2}\{\sqrt{5} - 1\}) = H(0.618034) = H_0/[X][Y] = H_0/1 = H_0 \text{ for scale factor } a = R(n)/R_H = X = 0.618034 = Y - 1$$

The corresponding n-cycle coordinate  $n_{XY} = X/(1-X) = X/X^2 = 1/X = Y = 1.618034$  for

$$R(n=Y) = YR_H/(Y+1) = (\sqrt{5} + 1) R_H/(\{\sqrt{5} + 3\}) = \frac{1}{4}R_H(3-\sqrt{5})(1+\sqrt{5}) = \frac{1}{2}R_H(\sqrt{5} - 1) = XR_H = 0.618034R_H$$

The unifying cycle coordinate in the compressed dS spacetime is reached at the X-cycle coordinate in the return of the AdS Lightpath for  $Y=n_{XY}=1.618034 Y/H_0=YR_H/c$  or 27.306 billion years from the QBBS



*Abomination of Sexual Desolation  
SheHe---Dragonomy---HeShe  
Inner She-Outer HeHe Outer-She Inner*

*Lake of Fire ♀ and ♂ Brimstone  
SheHe---Dragonomy---SheHe  
Inner She-Outer HeShe Outer-He Inner*



THE GREAT SYMBOL OF SOLOMON

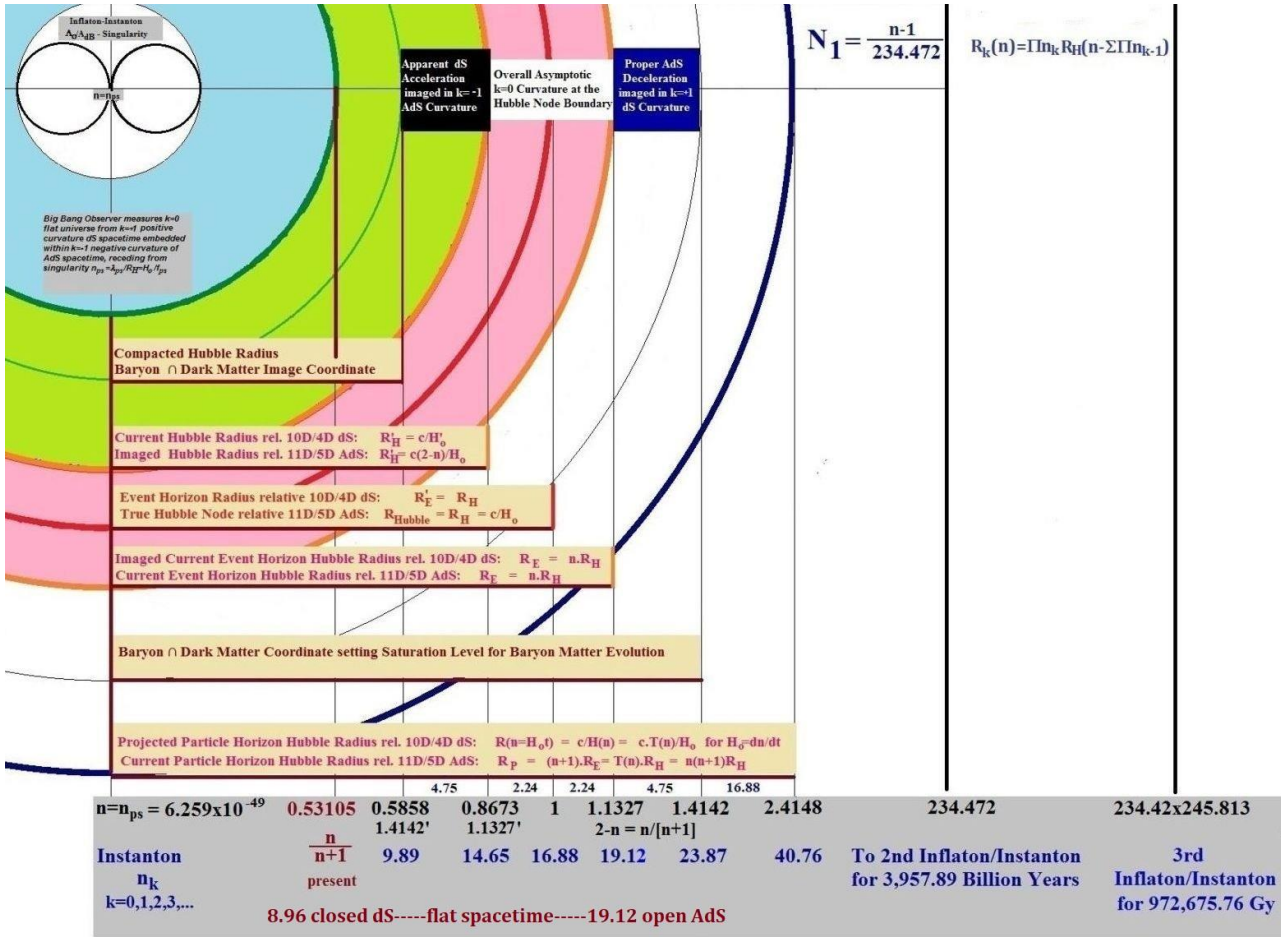

A second universe was born at the instanton of the AdS refractive Lightpath initially reaching the nodal mirror of its own refractive dS boundary.

The QBBS boundary conditions define  $H_0 = c/R_H = 1.877728045455 \times 10^{-18} [s^{-1}]^*$  or 58.04 km/Mpc.s from  $R_H = \sqrt[3]{2\pi^2 H} = 1.59767545 \times 10^{26} m^*$  and where H is a googol of space quanta defined in the QBBS and the units of measurement are calibrated from a star unit system resulting in calibrating  $c^*[m/s]^* = c_{SI}[1.001671357/1.000978394][m/s]_{SI}$

The value for a dark matter inclusive oscillating Hubble parameter is applicable to the de Sitter closed spacetime whenever  $n \geq 1$  to effectively decompress dS to AdS spacetime with Hubble parameter  $H_0/n$ .

$H(n_{present}) = H(n_{AdS}) = H_0/(2-n_{present}) = H_0/0.867288 = [2.165057 \times 10^{-18} [1/s]^*]$  or 66.92 km/Mpc. s for a universal age of 14.636 Gy in both mensuration systems for cosmological measurement accuracy.

The dark matter sector is defined as a baryon core (BM) – dark matter (DM) halo mass-matter distribution and is described in a density ratio of the combined BM+DM to the closure mass  $M_H$ :

$$\rho_{BMUDM}/\rho_{critical} = M_o Y^n R_H^3 / M_H R_H^3 (n/[n+1])^3 = \Omega_o Y^n \{1+1/n\}^3 = \Omega_{BM} \{1+1/n\}^3 \text{ for } \Omega_{DM} = \Omega_{BM} \{(1+1/n)^3 - 1\}$$

The value for a dark matter exclusive and therefore a compressed dS spacetime is found in the actual Hubble parameter not as a function of cycle time  $n=H_0t$ , which incorporates the dark matter, but as a function of cycle time  $n$  as given by the scale factor as a proportion of the nodal Hubble frequency interval.

The scale factor for the present time  $a = n/[n+1] = H_0t/[H_0t+1] = 0.5311134$  defining the present compressed dS spacetime without the dark matter to have completed 53.11 % of the nodal Hubble horizon interval.

The Hubble parameter  $H_0/T(n) = H_0/T(a) = H_0\{[n+1]/n\}\{[n+1]/[2n+1]\} = H_0[n+1]^2/n[2n+1]$  for the present time then calculates as  $H(n,t)|_{dS} = H(n_{pds}) = H_0[n_p+1]^2/n_p(2n_p+1) = 1.22972H_0 = [2.309075 \times 10^{-18} \text{ [1/s]}^*$  or 71.37 km/Mpc. s for a universal age of 13.724 billion years.

Measurements by the Planck satellite of ESA, the European Space Agency over a number of years obtained the dark matter sector included value range for the Hubble parameter and measurements probing the relatively nearby universe obtained values for the Hubble parameter above the 70 km/Mpc.s range as applicable for a compressed spacetime without the dark matter sector.

Measuring the Hubble parameter within the compressed dS spacetime so will result in values greater than the value at the lower dimensional Hubble boundary. Those measurements will converge as a mean value relative to the compressed boundary value at a  $n=1/2$  for the onset of the dark energy epoch in the multidimensional cosmology.

Values for the ‘Hubble tension’ for cosmological distance scales such as cepheid variable stars and SN1a supernovae, such as the SHOES and Baryon Oscillation Spectroscopic Survey BOSS and Baryonic Acoustic Oscillations BAO projects will converge to such a value range for a more proximate universe. {Adam Riess, Tehran, 2021, Supernovae  $H_0$  for the dark energy Equation of State}

[\[2103.01183\] In the Realm of the Hubble tension \\$-\\$ a Review of Solutions \(arxiv.org\)](#)

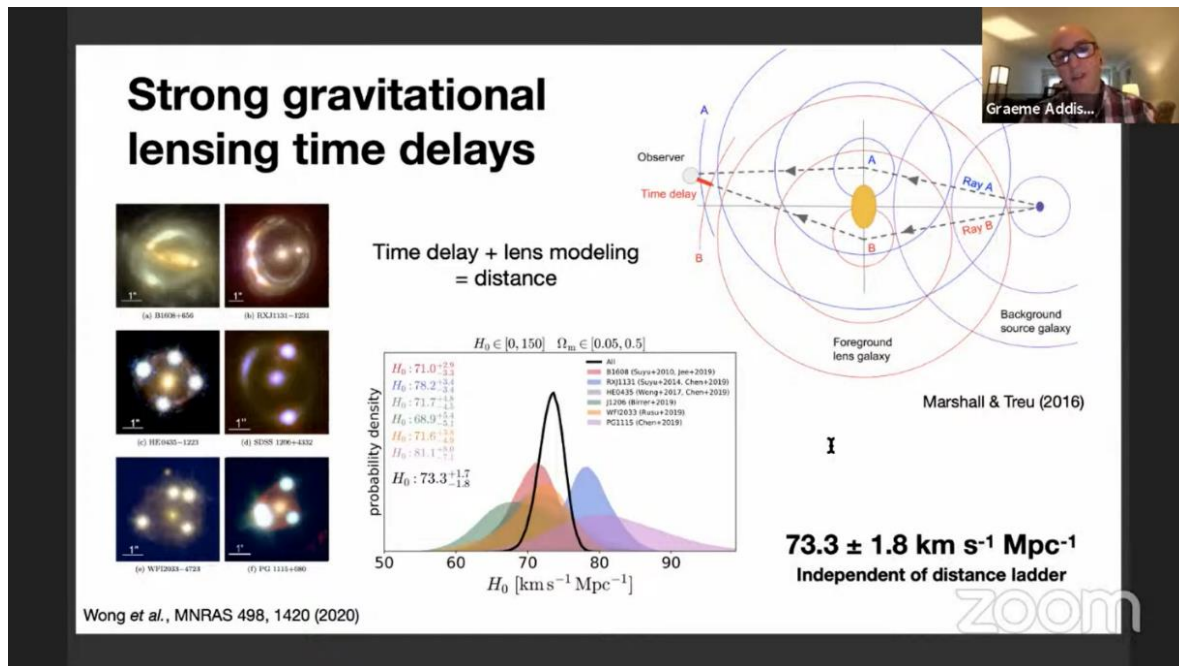

$H(n,t)|_{dSDE} = H(n=1/2) = H_0/[1/2][1+1/2] = 4H_0/3 = 1.33333H_0 = 2.5036374 \times 10^{-18} [1/s]^*$  or 77.39 km/Mpc.s for a mean value of  $(71.37+77.39)/2 = 74.39$  km/Mpc. s for a universal age of 12.657 billion years.

$H(n,t)|_{dSDE=0} = H(n=0.489365) = H_0/[0.489365][1.489365] = 1.3720374H_0 = 2.57631305 \times 10^{-18} [1/s]^*$  or 79.63 km/Mpc.s for a mean value of  $(66.92+79.63)/2 = 73.275$  km/Mpc.s for a universal age of 12.300 billion years for the entire dS-AdS n-cycle time interval from the Page Time of the onset of dark energy changing as a fraction of the total energy distribution from negative to positive from  $n=0.489365$  to  $n=1/2$ .

<https://arxiv.org/abs/2112.04510>

[What's Happening with the Hubble Tension? - Graeme Addison \(John Hopkins University\) - YouTube](#)

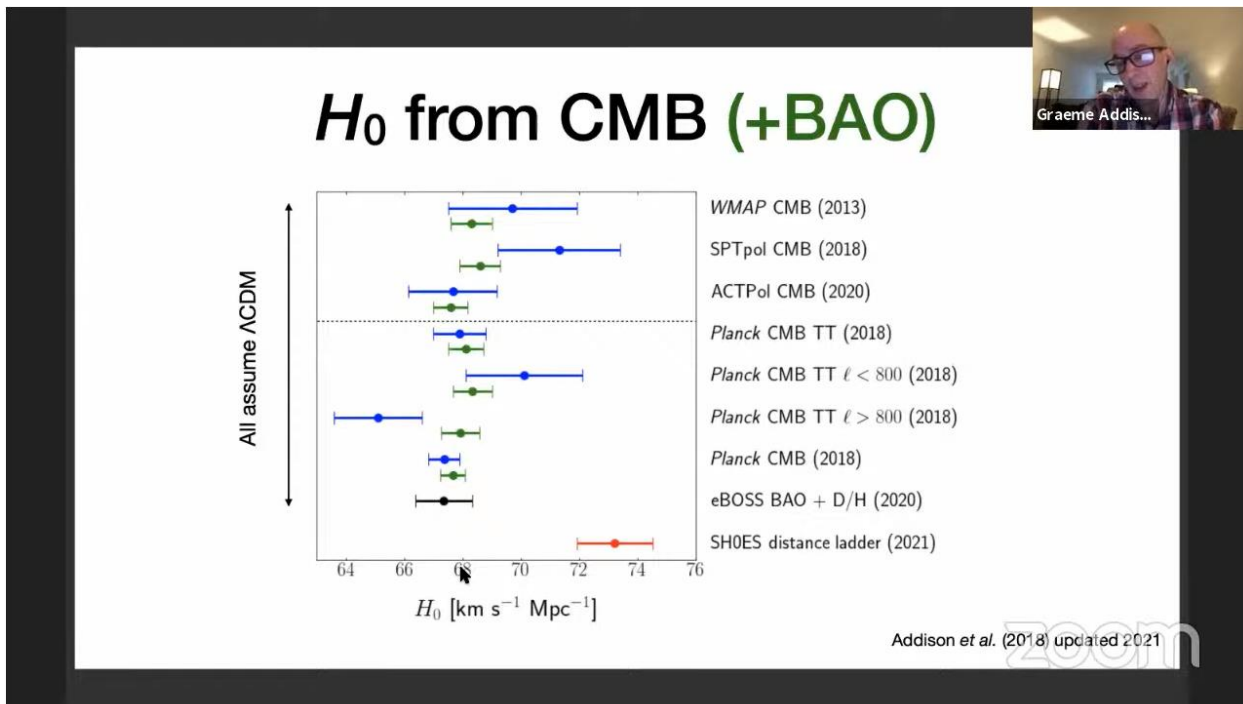

What's Happening with the Hubble Tension? - Graeme Addison (John Hopkins University)

Confirmation regarding DE and DM parameters, as well as neutrino masses, can be found in this link.

[Planck 2018 results - VI. Cosmological parameters | Astronomy & Astrophysics \(A&A\)\(aanda.org\)](#)

The 'Hubble tension,' the statistically significant discrepancy between the Planck ESA data using the CMB cosmic background radiation and the measurements for nearby astrophysical phenomena in galaxies, stellar distance scales and supernovas analyzed to validate the necessity for DE and the mechanics for an accelerating expansion for the universe is further addressed in this and other links:

[\(PDF\) The Accelerating Universe, Dark Energy & the Alpha Variation | Anthony P Bermanseder - Academia.edu](#)

[\(PDF\) Neutrino Discrepancies and Higgs Neutrino Oscillation Masses | Anthony P Bermanseder - Academia.edu](#)

[Prespacetime of QuantumDream, Inc.](#)

<https://arxiv.org/abs/2112.04510>

### 3.2. Hubble constant and dark-energy density

The degeneracy between  $\Omega_m$  and  $H_0$  is not exact, but the constraint on these parameters individually is substantially less precise than Eq. (12), giving

$$\left. \begin{aligned} H_0 &= (67.27 \pm 0.60) \text{ km s}^{-1} \text{ Mpc}^{-1}, \\ \Omega_m &= 0.3166 \pm 0.0084, \end{aligned} \right\} \begin{array}{l} (68\%, \text{ TT,TE,EE} \\ +\text{lowE}). \end{array} \quad (13)$$

It is important to emphasize that the values given in Eq. (13) assume the base- $\Lambda$ CDM cosmology with minimal neutrino mass. These estimates are highly model dependent and this needs to be borne in mind when comparing with other measurements, for example the direct measurements of  $H_0$  discussed in Sect. 5.4. The values in Eq. (13) are in very good agreement with the independent constraints of Eq. (6) from *Planck* CMB lensing+BAO. Including CMB lensing sharpens the determination of  $H_0$  to a 0.8% constraint:

$$H_0 = (67.36 \pm 0.54) \text{ km s}^{-1} \text{ Mpc}^{-1} \quad \begin{array}{l} (68\%, \text{ TT,TE,EE} \\ +\text{lowE+lensing}). \end{array} \quad (14)$$

This value is our “best estimate” of  $H_0$  from *Planck*, assuming the base- $\Lambda$ CDM cosmology.

Since we are considering a flat universe in this section, a constraint on  $\Omega_m$  translates directly into a constraint on the dark-energy density parameter, giving

$$\Omega_\Lambda = 0.6847 \pm 0.0073 \quad \begin{array}{l} (68\%, \text{ TT,TE,EE} \\ +\text{lowE+lensing}). \end{array} \quad (15)$$

The dark matter sector so resides in the AdS universe of negative curvature and interacts with the dS sector gravitationally from the higher dimensional, say Kaluza-Klein 5D spacetime perspective. This interaction is the reason for the lower dimensional thermodynamic EPM expansion to form a compacted Hubble event horizon in its own boundary of the baryon seed  $M_0$ .

The experimental measurements and analysis of dark matter haloes diffusing from galactic centers gravitationally, so mirrors the AdS sector of the nodal cosmology of the baryonic protoverse embedded in a dark matter universe in co-locality of the EMR Lightpath and the reflective EMMR Lightpath.

The dS universe is gravitationally compacted in its own closure and positive curvature because the baryon seed  $M_0$  was defined in ylemic Gamow Vortex potentials distributed by the instanton-inflaton epoch creating the hyperspacetime for the nodal Hubble universe. The EMMR reflective coordinate defines a projected vantage point for any universal observer as a ‘cosmic wave surfer’ however.

The dS Lightpath is parallel the AdS Lightpath as the natural intersection of the interdimensional invariance for lightspeed  $c$  and Einstein’s postulates of both Special and General Relativity.

It is well known that the Radius of Curvature in the Field Equations of General Relativity relates to the Energy-Mass Tensor in the form of the critical density  $\rho_{\text{critical}} = 3H_0^2/8\pi G$  and the Hubble Constant  $H_0$  as the square of frequency or alternatively as the time differential of frequency  $df/dt$  as a cosmically applicable angular acceleration independent on the radial displacement.

The scientific nomenclature (language) then describes this curved space in differential equations relating the positions of the 'points' in both space and time in a 4-dimensional description called Riemann Tensor Space or similar.

This then leads mathematically to the formulation of General Relativity in Einstein's Field Equations:

$$R_{\mu\nu} - \frac{1}{2}g_{\mu\nu} R + g_{\mu\nu}\Lambda = \frac{8\pi G}{c^4}T_{\mu\nu}$$

for the Einstein-Riemann tensor

$$G_{\mu\nu} = R_{\mu\nu} - \frac{1}{2}Rg_{\mu\nu},$$

and is built upon ten so-called nonlinear coupled hyperbolic-elliptic partial differential equations, which are mathematically rather complex and often cannot be solved analytically without simplifying the geometries of the parametric constituents (say objects interacting in so called tensor-fields of stress-energy  $\{T_{\mu\nu}\}$  and curvatures in the Riemann-Einstein tensor  $\{G_{\mu\nu}\}$ , either changing the volume in reduction of the Ricci tensor  $\{R_{ij}\}$  with scalar curvature  $R$  as  $\{Rg_{\mu\nu}\}$  for the metric tensor  $\{g_{\mu\nu}\}$  or keeping the volume of considered space invariant to volume change in a Tidal Weyl tensor  $\{R_{\mu\nu}\}$ ).

The Einstein-Riemann tensor then relates Curvature Radius  $R$  to the Energy-Mass

tensor  $E=Mc^2$  via the critical density as  $8\pi G/c^4=3H_0^2V_{\text{critical}}M_{\text{critical}}\cdot c^2/M_{\text{critical}}\cdot c^4 = 3H_0^2V_{\text{critical}}/c^2 = 3V_{\text{critical}}/R^2$  as Curvature Radius  $R$  by the Hubble Law applicable say to a nodal Hubble Constant  $H_0 = c/R_{\text{Hubble}}$

The cosmological field equations then can be expressed as the square of the nodal Hubble Constant and inclusive of a 'dark energy' term often identified with the Cosmological Constant of Albert Einstein, here denoted  $\Lambda_{\text{Einstein}}$ .

Substituting the Einstein Lambda with the time differential for the square of nodal Hubble frequency as the angular acceleration acting on a quantized volume of space; however, naturally, and universally replaces the enigma of the 'dark energy' with a space inherent angular acceleration component, which can be identified as the 'universal consciousness quantum' directly from the standard cosmology itself.

The field equations so can be generalised in a parametrization of the Hubble Constant assuming a cyclic form, oscillating between a minimum and maximum value given by  $H_0=dn/dt$  for cycle time  $n=H_0t$  and where then time  $t$  is the 4-vector time-space of Minkowski light-path  $x=ct$ .

The Einstein Lambda then becomes then the energy-acceleration difference between the baryonic mass content of the universe and an inherent mass energy related to the initial condition of the oscillation parameters for the nodal Hubble Constant.



**$\Lambda_{\text{Einstein}} = G_0 M_0 / R(n)^2 - 2cH_0 / (n+1)^3 = \text{Cosmological Acceleration} - \text{Native Milgröm Deceleration}$**

As  $g_{\mu\nu}\Lambda = 8\pi G/c^4 T_{\mu\nu} - G_{\mu\nu}$  for  $G_{\mu\nu} = 8\pi G/c^4 T_{\mu\nu} - g_{\mu\nu}\Lambda$ , a negative integrated  $\Lambda = 0$  can appear as the energy-stress tensor  $8\pi G/c^4 T_{\mu\nu}$  always being greater than the curvature tensor  $G_{\mu\nu}$  and restated in a mass independent form for an encompassment of the curvature fine structures.

The Friedmann equations for the Friedmann-Robertson-Walker FRW model for the field equations of General Relativity relate the dark energy pressure  $P$  to the matter density  $\rho(t)$  as an integrated part of a Lambda Cold Dark Matter  $\Lambda$ CDM model for the multidimensional cosmology for a flat Minkowski universe, albeit as an effect of the collocal interaction of a positively curved de Sitter  $dS$  universe with a negatively curved Anti de Sitter  $AdS$  universe.

The  $g_{\mu\nu}\Lambda = 8\pi G/c^4 T_{\mu\nu} - G_{\mu\nu}$  cosmological constant-quintessence tensor becomes integrated as the difference between the Energy-Stress tensor  $8\pi G/c^4 T_{\mu\nu}$  and the curvature Einstein-Riemann tensor  $G_{\mu\nu}$  with negative pressure  $P(n,t)$  describing the matter density  $\rho(n,t)$  as a change in the time rate change of the Hubble parameter  $dH(n,t)/dt$  and therefore the change in the intrinsic Milgröm deceleration as a function of the nodal Hubble parameter.

Pressure  $P(n,t)$  as an energy per unit volume  $Mc^2/R^3$  and its derivative are always negative, increasing as a functional part of the dark energy defined as an Einstein quintessence  $\Lambda(n)$  towards its  $w=0$  value for a matter dominated universe and can therefore be considered integrated as  $P < \rho c^2$  as  $P = w\rho c^2 \quad \forall w < 0$

$$P'(n, t) = \{-2c^2H_0^3/4\pi G_0\}\{[3n^2+3n+1]/T(n)^3\} - \{3(n+1)^2/n^4\}\{M_0c^2H_0/R_H^3\}$$

$$\{6\pi G_0 M_0/c^2 R_H\} = 3\pi\Omega_0 = 0.264176... > \{nT[n]-n[2n+1]^2\}/[n+1]^5 = -[3n^3+3n^2+n]/[n+1]^5 < 0 \quad \forall n, n_{ps} > 0$$

The derivative of the integrated pressure is defined in a maximum where matter density  $M_0c^2/R(n)^3$  is equal to a polynomial function native to the integrated pressure in  $\Lambda'_p(n) = n(2n+1)/[n+1]^5$ .

**Deceleration parameter**  $q(n) = -\{(d^2a/dt^2)(a)/(da/dt)^2\}$  for scale factor  $a = R(n,t)/R_H$

**Hubble Parameter**

$$H(n,t) = (da/dt)/a \text{ with } H(n=H_0t) = \{c/[n+1]^2\}/\{nR_H/[n+1]\} = H_0/(n[n+1]) = H_0/T(n)$$

$$dH(n,t)/dt = \{(d^2a/dt^2)/a - (da/dt)^2/a^2\} = -q(n)\{(da/dt)/a\}^2 - H(n,t)^2 = -H(n,t)^2\{1+q(n,t)\}$$

$$dH/dt = -H_0^2/(n^2[n+1]^2)\{1 + (2cH_0/[n+1]^3)(nR_H/[n+1])([n+1]^4/c^2)\} = -H_0^2/(n^2[n+1]^2)\{1 + (2cnH_0R_H/c^2)\}$$

$$dH(n=H_0t)/dn = -\{H_0/T(n)\}^2\{1+2n\} \text{ for } q(t) = -(dH/dt)/H(t)^2 - 1 = 1+2n-1 = 2n \text{ for } dS \text{ expanding within } AdS$$

**Einstein Quintessence Integrated Dark Energy Pressure**

From the continuity equation:  **$dp/dt = -3\{(da/dt)/a\}\{\rho + P/c^2\}$**  .....[Eq.VII-1]

The independent Einstein Field Equations of the Robertson-Walker metric reduce to the Friedmann equations:

$$H^2 = \{(da/dt)/a\}^2 = 8\pi G\rho/3 - kc^2/a^2 + \Lambda/3 \dots \dots \dots [\text{Eq.VII-2}]$$

$$\{(d^2a/dt^2)/a\} = -4\pi G/3\{\rho + 3P/c^2\} + \Lambda/3 \dots \dots \dots [\text{Eq.VII-3}]$$

$$dH/dt + 4\pi G\rho = -4\pi GP/c^2 \text{ for integrated Pressure } P(t) = -c^2\{(dH/dt)/4\pi G + \rho(t)\}$$

$$G_o\rho = G_oM_o/R(n)^3 = -G_oP/c^2 - (dH/dt)/4\pi = \Lambda(n)/R(n) + 2cH_o/R(n)[n+1]^3 \text{ for Volume } V_{ds} = 4\pi R(n)^3/3$$

$$-P(t) = \{c^2/G_o\} \{\Lambda(n)/R(n) + 2cH_o/R(n)[n+1]^3 + (dH/dt)/4\pi\}$$

$$= \{c^2/G_o\} \{\Lambda(n)[n+1]/nR_H + 2H_o^2/n[n+1]^2 - H_o^2(2n+1)/4\pi T(n)^2\}$$

$$P(n=H_o t) = \{c^2H_o^2/4\pi G_o T(n)^2\} \{2n+1-8\pi n+8\pi n\} - M_o c^2/R(n)^3 = c^2H_o^2(2n+1)/4\pi G_o T(n)^2 - M_o c^2/R(n)^3$$

$$P(n=H_o t) = c^2H_o^2(2n+1)/\{4\pi G_o T(n)^2\} - M_o c^2/R(n)^3 \text{ for the spherical } V_{ds} = 4\pi R(n)^3/3$$

$$P(n=H_o t) = c^2H_o^2(2n+1)/\{6\pi^2 G_o T(n)^2\} - M_o c^2/R(n)^3 \text{ for the hyper-spherical } V_{ds} = 2\pi^2 R(n)^3$$

The compressed dS spacetime is spherically closed and embedded within a spherical dark matter inclusive AdS spacetime. The Riemann hypersphere as a 3-dimensional surface derivative of a 3-sphere of volume  $V_4(R) = \frac{1}{2}\pi^2 R^4$  in  $dV_4/dR = 2\pi^2 R^3$  geometrically encompasses both interacting spacetimes in the horn torus topology coordinate shifted between the three frequency mirror intervals  $[-1,0]$  intersecting  $[-\frac{1}{2},+\frac{1}{2}]$  intersecting  $[0,1]$

These cosmic mirror-shifted Hubble horizons for the Light Energy universe and the Dark Energy shadow universe are then defined in an overall encompassing closed spherical universe defined by the Particle horizon of the expanding omniverse.

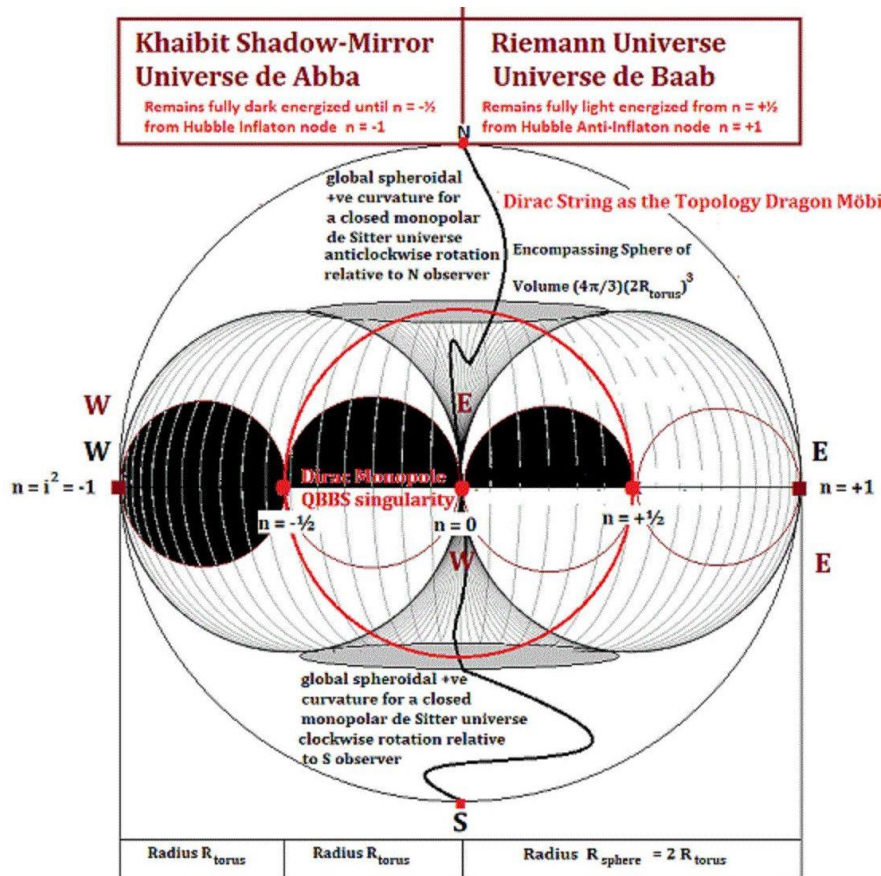

**For  $\Lambda'_p = 0$  the integrated negative pressure maximum coordinate for  $M_0c^2/R(n)^3 = \Lambda'_p(n)=0.40825$  for the derivative of  $\Lambda'_p(n)=(2n^2+n)/[n+1]^5 = 0.13389451796$  for  $d\{\Lambda'_p(n)\}/dn = 0$  for  $\Lambda''_p(n) = (4n+1)/[n+1]^5 - 5n(2n+1)/[n+1]^6 = 0$  for  $n=1/\sqrt{6} = 0.40825$**

Showing that the Pressure P would be 0 for this coordinate were it not integrated in the Lambda tensor

$\Lambda(0.40825)(R(0.40825)) = (41.04504)G_0M_0/R_H^3 - (2.47027)H_0^2 = (2.0282 - 8.70985)\times 10^{-36} [1/s^2]^*$  for a negative Einstein quintessence of  $-6.68165\times 10^{-36} [1/s^2]^*$

or  $\Lambda(0.40825)=\{9.3941-40.3402\}\times 10^{-11} = -3.0946\times 10^{-10} [ms^{-2}]^*$

$\rightarrow P(n,t) = c^2H_0^2(1.8165)/\{4\pi G_0(0.33053)\} - M_0c^2/R(n)^3 = (1.2490-1.6429)\times 10^{-9}$

$= -3.939\times 10^{-9} [J/m^3]^*$  for the spherical  $V_{ds} = 4\pi R(n)^3/3 [N/m^2]^*$  as the Lambda integrated pressure at 6.891 billion years after the QBBS as  $P(n=0.40825)$  to define a maximum  $2\pi\Omega_0=2\pi M_0/M_H$  in the baryon matter seedling with  $P'(0.40825) = -2.3844\times 10^{-26} [J/m^3s]^*$

**For  $\Lambda(n=n_{ps}=|\lambda_{ps}/R_H|_{mod}) = G_0M_0/\lambda_{ps}^2 = 2.015\times 10^{85} [m/s^2]^*$  and  $n_{ps}=\lambda_{ps}/R_H$  as min-max scale boundaries**

$\rightarrow P(n,t) = M_Hf_{ps}^2/R_H\{1/2\pi - \Omega_0/n_{ps}\} = 3.645\times 10^{87}\{1/2\pi - 4.478\times 10^{46} [N/m^2]^*\} O\{-1.63\times 10^{134}\} < 0$

for a spherical  $V_{ds} = 4\pi R(n_{ps})^3/3 = 4.18879\times 10^{-66} [m^3]^*$  for a boundary and initiation redshift  $z\sim 2\times 10^{24}$  of the instanton-inflaton QBBS with  $\rightarrow dP(n,t)/dt = P'(n,t) = \{-2c^5/4\pi G_0\lambda_{ps}^3\} - \{3M_0c^3/\lambda_{ps}^4\}$

$= \{-f_{ps}^3\}\{3M_0/\lambda_{ps} + c^2/2\pi G_0\} = \{-f_{ps}^3\}\{5.44\times 10^{73} - 1.29\times 10^{26}\} < 0$  for  $O(-1.47\times 10^{165}) [J/m^3s]^*$

**For  $\Lambda = 0$  the onset of the Einstein quintessence changing from positive to negative for  $n=0.10823$**

$\Lambda(n_0)(R(n_0)) = (1073.61)G_0M_0/R_H^3 - (84.56)H_0^2 = (5.3053 - 5.3053)\times 10^{-35} [1/s^2]^*$  for a negative Einstein quintessence of  $0 [1/s^2]^*$  for  $\Lambda(n_0) = \{8.2774 - 8.2774x\}\times 10^{-10} = 0 [ms^{-2}]^*$

$\rightarrow P(n,t) = c^2H_0^2(1.21646)/\{4\pi G_0(0.01439)\} - M_0c^2/R(n)^3 = (1.9212-4.2973)\times 10^{-8}$

$= -2.3761\times 10^{-8} [N/m^2]^*$  for the spherical  $V_{ds} = 4\pi R(n)^3/3 [N/m^2]^*$   $\rightarrow P'(n,t) = -2.6908\times 10^{-24} [J/m^3s]^*$

**For the onset of dark energy for deceleration parameter product  $q_{Ads}\cdot q_{ds} = 2(\frac{1}{2})(1/1-1) = 0$  for  $n=\frac{1}{2}$**

$\Lambda(n_{DE})/(R(n_{DE})) = (27)G_0M_0/R_H^3 - (16/9)H_0^2 = (1.3342 - 6.2680)\times 10^{-36} [1/s^2]^*$  for a negative Einstein quintessence of  $-4.9339\times 10^{-36} [1/s^2]^*$  for  $\Lambda(n_{DE}) = -2.6276\times 10^{-10} [ms^{-2}]^*$

$\rightarrow P(n,t) = c^2H_0^2(2)/\{4\pi G_0(9/16)\} - M_0c^2/R(n)^3 = (8.0807-10.8071)\times 10^{-10} = -2.7264\times 10^{-10} [N/m^2]^*$  for the spherical  $V_{ds} = 4\pi R(n)^3/3 [N/m^2]^*$   $\rightarrow P'(n,t) = -1.4692\times 10^{-26} [J/m^3s]^*$

**For the completion of the AdS Lightpath at the 1<sup>st</sup> odd Hubble node  $H_0 = c/R_H$  for  $n=1$**

$\Lambda(1)/(R(1)) = (8)G_0M_0/R_H^3 - (8/9)H_0^2 = (1.3342 - 3.1341)\times 10^{-36} [1/s^2]^*$  for a negative Einstein quintessence of  $-1.8000\times 10^{-36} [1/s^2]^*$  for  $\Lambda(1) = -1.4378\times 10^{-10} [ms^{-2}]^*$

$\rightarrow P(n,t) = c^2H_0^2(3)/\{4\pi G_0(4)\} - M_0c^2/R(n)^3 = (1.7045-3.2021)\times 10^{-10} = -1.4976\times 10^{-10} [N/m^2]^*$  for the spherical  $V_{ds} = 4\pi R(n)^3/3 [N/m^2]^*$   $\rightarrow P'(n,t) = -1.6486\times 10^{-27} [J/m^3s]^*$

**For the present time  $n=1.132712$**

$\Lambda(n_{present})/(R(n_{present})) = G_0M_0/R_H^3(n/[n+1])^3 - 2nH_0^2/T(n)^2 = (3.2984 - 13.686)\times 10^{-37} [1/s^2]^*$  for a negative Einstein quintessence of  $-1.08387\times 10^{-36} [1/s^2]^*$  for  $\Lambda(n_{present}) = -8.8143\times 10^{-11} [ms^{-2}]^*$

$\rightarrow P(n,t) = c^2H_0^2(3.2654)/\{4\pi G_0(5.8358)\} - M_0c^2/R(n)^3 = (1.2713-2.6717)\times 10^{-10}$

$= -1.4004\times 10^{-10} [J/m^3]^*$  for the spherical  $V_{ds} = 4\pi R(n)^3/3 [N/m^2]^*$   $\rightarrow P'(n,t) = -1.1223\times 10^{-27} [J/m^3s]^*$

**For the quantum tunneling of the asymptotic protoverse into the first universe for n=234.4715**

$$\Lambda(n_{\text{quantumtunnel}})/(R(n_{\text{quantumtunnel}}) = G_o M_o / R_H^3 (n/[n+1])^3 - 2nH_o^2 / T(n)^2 = 5.0051 \times 10^{-38} - 5.4241 \times 10^{-43}$$

$$= O(5 \times 10^{-38}) [1/s^2]^* \text{ for a positive Einstein quintessence of } 5.0051 \times 10^{-38} [1/s^2]^*$$

$$\text{for } \Lambda(n_{\text{quantumtunnel}}) = 7.9624 \times 10^{-12} [ms^{-2}]^*$$

$$\rightarrow P(n,t) = c^2 H_o^2 (469.943) / \{4\pi G_o (3.0483 \times 10^9)\} - M_o c^2 / R(n)^3 = (3.5037 \times 10^{-17} - 4.0541 \times 10^{-11})$$

$$= -4.0541 \times 10^{-11} [N/m^2]^* \text{ for the spherical } V_{dS} = 4\pi R(n)^3 / 3 [N/m^2]^* \rightarrow P'(n,t) = -4.1371 \times 10^{-33} [J/m^3 s]^*$$

The AdS expansion has scale factor  $a = nR_H/R_H = n$  with invariant recession velocity  $c$  and 0 acceleration and is a function of  $n=H_o t$  limited in the Particle Hubble event horizon  $R_p(n) = T(n)R_H = n(n+1)R_H$ .

As the deceleration parameter will be  $q=2$  for  $n=1$  for the nodal Hubble boundary  $H_o$  for the dS-AdS spacetime mirror for the EMMI Lightpath a product  $q_{AdS} \cdot q_{dS} = 2n(1/2n - 1) = 1 - 2n$  with a superposed deceleration parameter  $q_{dS}$  for the cyclic cosmology of the EMR Lightpath initializes the dark energy onset for  $n=1/2$  to give the deceleration parameter product a zero value.

This then defines  $q_{dS}(n) = 1/2n - 1$  generally and  $q_{dS} = -1/2$  for  $q_{AdS} = 2$  for nodal Hubble bound  $n=1$

For a present cycle time coordinate  $n=1.1327117... q_{AdS} = 2.26542$  and  $q_{dS} = -0.5586$ , the  $q_{dS}$  value being measured by astrophysical experiments as

$$q_o = 1/2 \Omega_{DMUBM} - \Omega_{DE} = 0.162 - 0.677 = -0.515 > 1/2 \Omega_{DM} - \Omega_{DE} = 0.137 - 0.677 = -0.540$$

Dark energy initiation for  $n=1/2$  then occurs for  $q_{AdS} = 1$  with  $q_{dS} = 1/1 - 1 = 0$

This stipulates a Hubble time  $(1.132712 - 1/2)/H_o = 0.632712/H_o = 10.677$  billion years ago for the open AdS spacetime and a Hubble time  $(0.867288 - 1/2)/H_o = 0.367288/H_o = 6.198$  billion years ago for the closed and compressed dS spacetime.

The cosmological relativistic Doppler redshift is  $z_{DE}=0.6124$  for a Cosmic radiation background temperature of  $4.254 K^*$ .

**Baryon Matter, Dark Matter and Dark Energy distribution in  $\Omega_{BM} + \Omega_{DM} + \Omega_{DE} = 1 = \Omega_o f(n) + \Omega_{DE}$   
 $\Omega_{DE} < 0$  for  $n < n_{DE=0}$  and  $\Omega_{DE} = 0$  for  $n = n_{DE=0}$  and  $\Omega_{DE} > 0$  for  $n > n_{DE=0}$**

The density ratio  $\rho_{BMUDM} / \rho_{critical} = M_o Y^n R_H^3 / M_H R_H^3 (n/[n+1])^3 = \Omega_o Y^n \{1+1/n\}^3 = \Omega_o f(n) = \Omega_{BM} \{1+1/n\}^3$

$$\rho_{BMUDM} / \rho_{critical} + \Omega_{DE} = 1 = \Omega_o f(n) + \Omega_{DE} = \Omega_{BM} \{1+1/n\}^3 + \Omega_{DE}$$

For  $\Omega_{DM} = \Omega_{BM} \{ (1 + 1/n)^3 - 1 \} = \Omega_o (1.618033)^{1.132712} \{ 5.67480 \} = \{ 0.048344 \} \{ 5.67480 \} = 0.274344$  and  $\Omega_{DE} = 1 - \Omega_{DM} - \Omega_{BM} = 1 - \Omega_{BM} \{ (1+1/n)^3 \} = 1 - 0.048344 \{ 6.67480 \} = 0.677313$  for the present time  **$\Omega_{BM} = 0.048344$  with  $\Omega_{DM} = 0.274344$  with  $\Omega_{DE} = 0.677313$**

As  $G_o M_o = G(n) X^n M(n) Y^n = G(n) X^n \{M_i + M_j\} (n) Y^n = G(n) X^n \{M_{BM} + M_{DM}\} (n) Y^n = \text{constant}$   
 with  $\Omega_o Y^n = \Omega_{BM}$   $G_o X^n \cdot Y^n \Omega_o = G(n) \Omega_{BM}$  for  $2\pi \Omega_o - \Lambda_{Pmax}(n=0.40825)$

$$1 + 2\pi \Omega_o - \Lambda' |_{max} = G(n_{measured}) / G_o X^n + \delta = \Omega_o G_m Y^n / \Omega_{BM} G(n) + \delta \text{ for a measured } G_m = G(n_{measured})$$

$$1 + 0.176117 - 0.1338945 + \delta = 1.0422225 + \delta = \{ 0.02803 Y^n / 0.04834 \} Y^n \{ G_m \} / G(n)$$

$$= 1.00009 \{ G_m / 6.442195 \times 10^{-11} \}$$

for a monopole derived delta  $\delta = 1.0422225 - 1.035428 = 0.006794$   
 $G_m = 6.4416152 \times 10^{-11} \{ 1.042225 + \delta \} = 6.6698 \times 10^{-11} [m^3/kg.s^2]^*$  and  $6.67443 \times 10^{-11} [m^3/kg.s^2]_{Si}$

The Dark Energy and the 'Cosmological Constant' exhibiting the nature of an intrinsic negative pressure in the cosmology became defined in the overall critical deceleration and density parameters.

The energy density  $M_o c^2/R(n)^3$  as the energy-stress tensor always exceeds Pressure  $P(n,t)$  and its derivative  $dP(n,t)/dt$ .

The pressure term in the Friedmann equations being a quintessence of function  $n$  and changing sign from positive to negative to positive as indicated.

The encompassing cosmology so is always matter dominated in the sense of the overall energy distribution and the asymptotic zero approach of the integrated negative pressure quintessence.

**Critical Density  $\rho_c = 3H_o^2/8\pi G_o$  dS with  $\rho_c = H_o^2/4\pi^2 G_o$  AdS in factor  $3\pi/2$**

$$\text{for } H(n)^2 = \{da/dt\}^2/a^2 = \{c^2/[n+1]^4\}/\{n^2 R_H^2/[n+1]^2\} = H_o^2/n^2[n+1]^2 = H_o^2/T(n)^2$$

for  $\{da/dt\}^2 = 8\pi G_o \rho_c a^2/3$  dS and  $\{da/dt\}^2 = 4\pi^2 G_o \rho_c a^2$  AdS for spherical closure dS in omnispacetime as a function of the Particle Hubble event horizon of the nodal cosmology for critical density  $\rho_{\text{critical}}$  and curvature radius  $R_{\text{curv}} = 2G_o M_H/c^2$  and scale factor  $a(n,t)=R(n,t)/R_H$

$$\int da/a = \int \sqrt{\{8\pi G_o \rho_c/3\}} dt \text{ dS and } \int da/a = \int \sqrt{\{4\pi^2 G_o \rho_c\}} dt \text{ AdS}$$

$$\text{for } \ln\{a\} = \sqrt{\{8\pi G_o \rho_c/3\}} t \text{ dS and } \ln\{a\} = \sqrt{\{4\pi^2 G_o \rho_c\}} t \text{ AdS}$$

**for  $a(t) = \exp[\sqrt{\{8\pi G_o \rho_c/3\}} t] = \exp[H_o] \text{ dS}$  and  $a(t) = \exp[\sqrt{\{4\pi^2 G_o \rho_c\}} t] = \exp[H_o] \text{ AdS}$**

This correlates with a generalised density  $\rho(n=H_o t)$  varying cosmology, often modelled as a flat matter only de Sitter universe with scale factor  $a(n,t) = R(n)/R_H = R(n)H_o/c \propto t^{2/3}$

$$H(n) = \{(dR(t)/dt)/R_H\}/\{R(t)/R_H\} = \sqrt{\{8\pi G_o \rho(n,t)/3\}} = \sqrt{\{8\pi G_o (M(n,t)/3R(n,t)^3)\}} \text{ dS and}$$

$$H(n) = \{(dR(t)/dt)/R_H\}/\{R(t)/R_H\} = \sqrt{\{4\pi^2 G_o \rho(n,t)\}} = \sqrt{\{4\pi^2 G_o (M(n,t)/R(n,t)^3)\}} \text{ AdS}$$

$$\text{For } \sqrt{R(t)}.dR(t) = \sqrt{\{8\pi G_o (M(n,t)/3)\}}.dt \text{ dS and } \sqrt{R(t)}.dR(t) = \sqrt{\{4\pi^2 G_o (M(n,t))\}}.dt \text{ AdS}$$

$$\text{For } \sqrt[2/3]{R(t)}^{1.5} = \sqrt{\{8\pi G_o (M(n,t)/3)\}} t \text{ and } R(t) = \sqrt[3]{\{6\pi G_o (M(n,t))\}} t^{2/3} \text{ dS and}$$

$$\text{for } \sqrt[2/3]{R(t)}^{1.5} = \sqrt{\{4\pi^2 G_o (M(n,t))\}} t \text{ and } R(t) = \sqrt[3]{\{9\pi^2 G_o (M(n,t))\}} t^{2/3} \text{ AdS within the closed dS omniverse}$$

For AdS encompassing the cyclic dS protoverse as a multiverse as a closed dS spacetime, the scale factor is  $a=n=H_o t$  for  $dn/dt=H_o$  for the Particle Horizon and closure  $n=1$  for  $M(n,t)=M_H=R_{\text{curv}}c^2/2G_o$  with

$$nR_H=R(n,t) = \sqrt[3]{\{6\pi G_o (M(n,t))\}} [n/H_o]^{2/3} \text{ dS for } nR_H^3 = \{6\pi G_o (M(n,t)/H_o^2)\} = 9M(n,t)/4\rho_c \text{ and}$$

$$n = 9M(n,t)/4\rho_c R_H^3 = \{9M(n,t)/4R_H^3\}\{4\pi R_H^3/3M_H\} = 3\pi\{R_{\text{curv}}/R_H\} = 3\pi \text{ for } M(n,t) = M_H \text{ and } n=1$$

For the dS omniverse encompassing the cyclic dS protoverse as a multiverse as AdS spacetime in the topology of a horn torus, the scale factor is  $a=n=H_o t$  for  $dn/dt=H_o$  for the Particle Horizon and closure  $n=1$  for  $M(n,t)=M_H=R_{\text{curv}}c^2/2G_o$  with

$$nR_H=R(n,t) = \sqrt[3]{\{9\pi^2 G_o (M(n,t))\}} [n/H_o]^{2/3} \text{ dS for } nR_H^3 = \{9\pi^2 G_o (M(n,t)/H_o^2)\} = 9M(n,t)/4\rho_c \text{ and}$$

$$n = 9M(n,t)/4\rho_c R_H^3 = \{9M(n,t)/4R_H^3\}\{2\pi^2 R_H^3/M_H\} = 9\pi^2/2 \text{ for } M(n,t) = M_H \text{ and cycle } n=1$$

The time for closure so becomes about one third the Hubble time  $1/H_o = R_H/c$  in

$$t^2 = R_H^3/6\pi G_o M_H = R_H/3\pi H_o^2 R_{\text{curv}} = 1/3\pi H_o^2 \text{ for a time } t=1.73473 \times 10^{17} \text{ s}^* \text{ or } n=0.32573 \text{ or } 5.4971 \text{ Gy, when}$$

$$R(t=n/H_o) = 3.9253 \times 10^{25} \text{ m}^* = 0.2457 R_H$$

For a present measured deceleration parameter  $q_{dS} = -0.5586$ , the DE Lambda as the negative Einstein quintessence calculates as  $-8.8143 \times 10^{-11} \text{ [m/s}^2\text{]}$  or as  $1.0388 \times 10^{-36} \text{ [s}^{-2}\text{]}$  and as a negative pressure of  $-1.4004 \times 10^{-10} \text{ [N/m}^2\text{=J/m}^3\text{]}$  as a function of the native universal Milgröm deceleration  $a_{mil} = -2H_0^2 R_H / [n+1]^3 = -1.1614 \times 10^{-10} \text{ [m/s}^2\text{]}$ .

The Einstein Lambda then becomes the energy-acceleration difference between the baryonic mass content of the universe and an inherent mass energy related to the initial condition of the oscillation parameters for the nodal Hubble Constant.

For  $\Omega(n) = M(n)/M_H = 2q_0 = 1 = R(n)/R_H$  the AdS cosmology attains closure for a cycle coordinate  $n=1$  in the EMMR Lightpath and a time, when the dS gravitationally retarded universe has reached the halfway point in its asymptotically defined expansion in scale factor  $R(n,t)/R_H = n/[n+1] = a(n,t)$  in a recessional velocity of the expanding dS wavefront slower than the speed of light.

The dS compressed universe has reached the halfway marker for the onset of the dark energy at a cycle time coordinate of  $n=1$  and when the AdS dark matter inclusive universe has reached the nodal Hubble event horizon as the boundary for the multidimensional cosmology as set in the superluminal Lightpath of the QBBS superimposed onto the parallel evolution of the dS and AdS spacetimes expansion.

The extent of the EMMR Lightpath in AdS so encompasses a full nodal displacement in the interval  $[n_{ps} \sim 0, 1]$  which is phase shifted as the interval  $[-\frac{1}{2}, +\frac{1}{2}]$  to mirror the invariance of the EMR Lightpath relative to the gravitationally retarded EMR Lightpath in the cycle coordinate  $n = \frac{1}{2}$  as a proxy nodal mirror for the true Hubble node at  $n=1$ .

The 'return' of the reflected EMMR Lightpath from the true Hubble event horizon so is made manifest as the EMR Lightpath at the proxy Hubble node at the DE  $n$ -cycle coordinate  $n = \frac{1}{2}$  and for which the deceleration parameter product is zero for  $q_{AdS} = 2n = 1$  and  $q_{dS} = 1/q_{AdS} - 1 = 0$ .

The actual curvature radius for  $n = \frac{1}{2}$  for the dS cosmology is  $R(\frac{1}{2}) = \frac{1}{2} \cdot \frac{2}{3} R_H = \frac{1}{3} R_H$  to indicate that the dark matter portion for the compressed spacetime will be  $1/2^3 - 1/3^3 = 1/8 - 1/27 = 19/108 = 0.0880 = 1/11.36$  in terms of the volume occupied.

For  $n=1$ , the dark matter sector so will be doubled to  $0.1759 = 1/5.6842$  for the ratio between the dS sector without the dark matter and the AdS sector with the dark matter with  $1/6.6842 + 5.6842/6.6842 = 1$  or as so 15% BM and 85% DM as the total matter content of the universe.

The distribution for the present scale factor of  $0.53R_H$  gives  $\Omega_{BM} = \Omega_0 Y^{1.132712} = 0.04834$  and for  $n_{present}$   $\Omega_{DM} = \Omega_0 \{1 + 1/n\}^3 = 0.2743$  as  $4.834/32.262 = 14.98\%$  and  $27.43/32.262 = 85.02\%$ .

The difference between the AdS curvature radius for  $n=1$  superposed onto the dS curvature radius for  $n=1$  and the actual dS curvature radius for  $n = \frac{1}{2}$  then is  $(\frac{1}{2} - \frac{1}{3})R_H = \frac{1}{6}R_H$  for a ratio of  $\frac{1}{2}R_H / \frac{1}{3}R_H = 3/2$

The density parameter  $\Omega = R(n)/R_H = 1$  so triggers the second universe from the lightspeed invariant AdS completion of the Lightpath in the AdS cosmology with the Dark Energy manifesting in potential energy vortices of wormholes defined in the inflaton hyperspace cosmology and superpositioned as the phase shift of the  $[n_{ps}, 1]$  interval in the interval  $[-\frac{1}{2}, +\frac{1}{2}]$  as the dark energy onset.

This defines the Dark Energy onset for the difference between the AdS EMMI  $ct = nR_H$  Lightpath and the dS EMR expansion  $R(n) = nR_H/[n+1]$  as  $R_H \{n - n/[n+1]\} = R_H \{(T(n) - n)/[n+1]\} = n^2 R_H/[n+1] = \frac{1}{6}R_H$  for  $n = \frac{1}{2}$

This difference is trivially 0 for the QBBS and  $n=0 \sim n_{ps}$  and is 0 for the intersection coordinate for the stasis of the dark matter part with the baryonic matter part of the energy density for the cyclic return of the EMMI Lightpath  $ct=R_H\{2-n\} > R_H$  with  $\{2-n\}=n/[n+1]$  or  $2-n^2 = 0$  for  $n_{BMUDM} = \sqrt{2}$

For  $n=1$  and the nodal Hubble event horizon the AdS-dS difference  $n^2 R_H/[n+1] = \frac{1}{2} R_H$  for  $n/[n+1]$

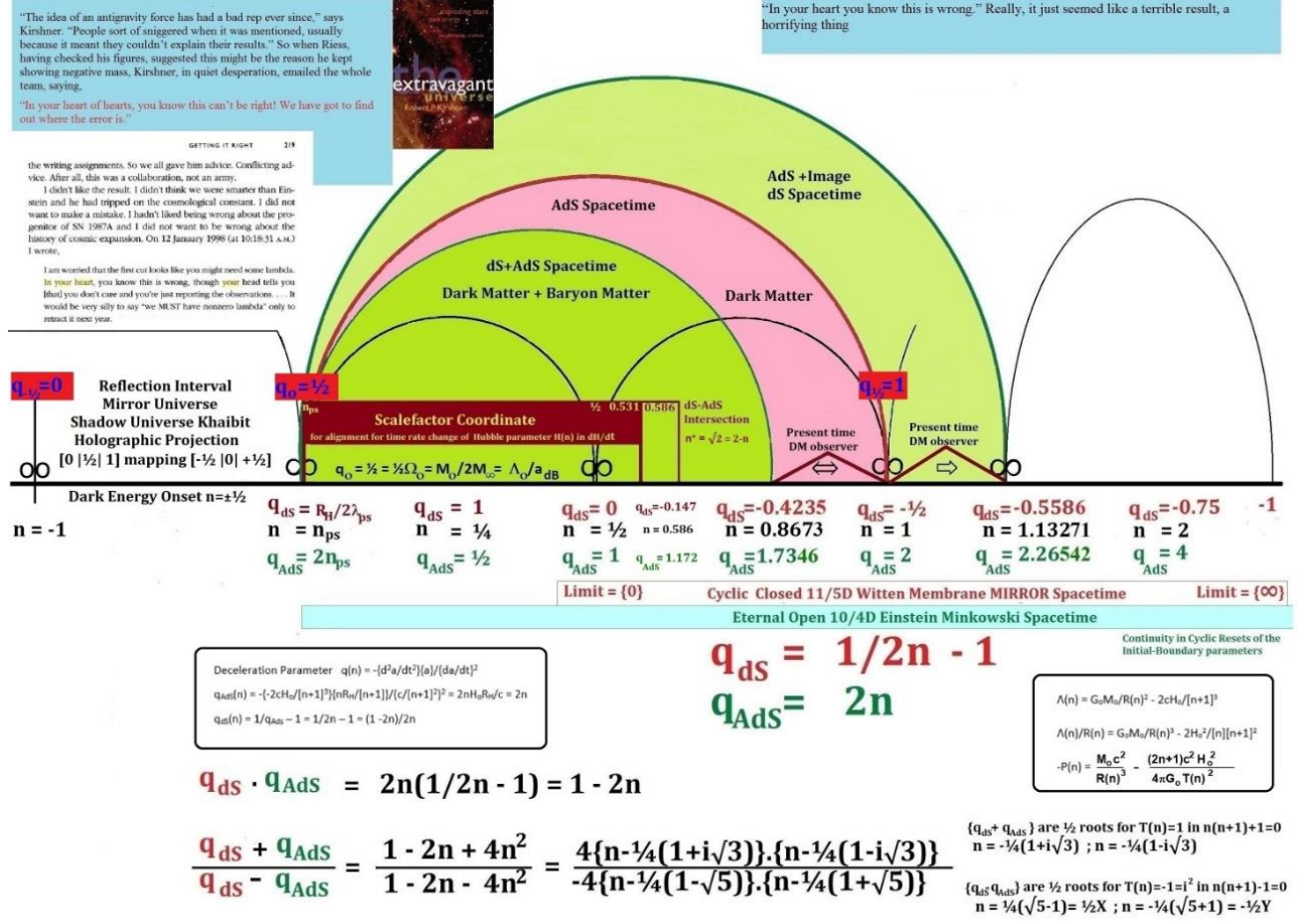

The cosmological observer is situated simultaneously in 10/4D Minkowski Flat dS spacetime, presently at the  $n=0.8676$  cycle coordinate and in 11/5D Mirror closed AdS spacetime, presently at the  $n=1.1327$  coordinate.

Observing the universe from AdS will necessarily result in measuring an accelerating universe; which is however in continuous deceleration in the gravitationally compressed dS spacetime for deceleration parameter  $q_{ds} = 2n$ . Gravitation is made manifest in the dS spacetime by Graviton strings from AdS spacetime as Dirichlet branes at the 10D boundary of the expanding universe mirroring the 11D boundary of the nodally fixed Event Horizon characterised by  $H_0 = c/R_H$

The Dark Matter region is defined in the contracting AdS lightpath, approaching the expanding dS spacetime, but includes any already occupied AdS spacetime. The Baryon seeded Universe will intersect the 'return' of the inflaton lighpath at  $n=2-\sqrt{2}=0.586$  for (DM=22.09 %; BM=5.55%; DE=72.36%).

The Dark Energy is defined in the overall critical deceleration and density parameters; the DE being defined in the pressure term from the Friedmann equations and changes sign from positive maximum at the inflaton-instanton to negative in the interval  $\Lambda(n)>0$  for  $n$  in  $[n_{ps} - 0.18023]$  and  $\Lambda(n) < 3.4008$  with  $\Lambda(n)<0$  for  $n$  in  $(0.1803 - 3.4008)$  with absolute minimum at  $n=0.2389$ .

This DE (quasi)pressure term for the present era (1-0.1498 for 85% DM of Matter 4.834% BM; 27.434% DM; 67.732% DE) is  $\Lambda_p = -1.4004 \times 10^{-10} \text{ J/m}^3 < 0 \neq n$  and is integrated into a Lambda quintessence of  $1.039 \times 10^{-36} \text{ s}^{-2}$  and from  $\Lambda(n_p) = -8.815 \times 10^{11} \text{ m/s}^2$

This pressure term will become asymptotically negative for a universal age of about 57.4 Gy and for a zero curvature evolution of the cosmos within the multiverse generations.

The dimensionless acceleration ratio  $q_0 = \Lambda_0/A_{dB} = M_0/2M_H = \frac{1}{2}\Omega_0$  assumes the value  $q_0 = \frac{1}{2}$  for  $n = \frac{1}{3}$  and when the radial size of the universe is at halfway nexus at  $\frac{1}{2}R_H$  for the intersection coordinate between the AdS lightspeed invariant expansion and the Dark Energy onset at redshift  $z = 0.6124$  for the dS gravitationally retarded cosmology and for  $R(\frac{1}{2}) = \frac{1}{2}R_H/[1+\frac{1}{2}] = \frac{1}{3}R_H$

At the instanton  $t_{ps}$ , a de Broglie Phase-Inflation defined  $r_{max} = a_{dB}/f_{ps}^2$  and a corresponding Phase-Speed  $v_{dB} = r_{max} \cdot f_{ps}$ .

Those de Broglie parameters constitute the boundary constants for the Guth-Linde inflation and the dynamical behaviour for all generated multiverses as subsets of the omniverse in superspacetime CMF.

Initially, the de Broglie Acceleration of Inflation specified the overall architecture for the universe in the Sarkar Constant  $A_S = A_E(n_{ps}) r_{max} / a_{dB} = G_O M_O / c^2$

The Sarkar Constant calculates as 72.4 Mpc,  $2.23541620 \times 10^{24}$  m or as 236.12 Mlightyears as the bounding gravitational distance/scale parameter.

A Scalar Higgsian Temperature Field derives from the singularity and initialises the consequent evolution of the protocosmos in the manifestation of the bosonic superbranes as macroquantisations of multiverses in quantum relativistic definitions.

The Omega of critical density is specified in acceleration ratio  $A_E(n_{ps})/a_{dB}$ , which is  $G_O M_O / c^2 r_{max} = 0.01401506 = \frac{1}{2} M_O / M_\infty = \frac{1}{2} \Omega_O = q_O$  (Deceleration Parameter).

$$\frac{2G_O M_O}{c^2} \frac{2c^2}{R_H^2} = \frac{4c^2 G_O M_O}{R_H R_H c^2} = \Omega_O 2cH_O \quad \Omega_O = 0.02803$$

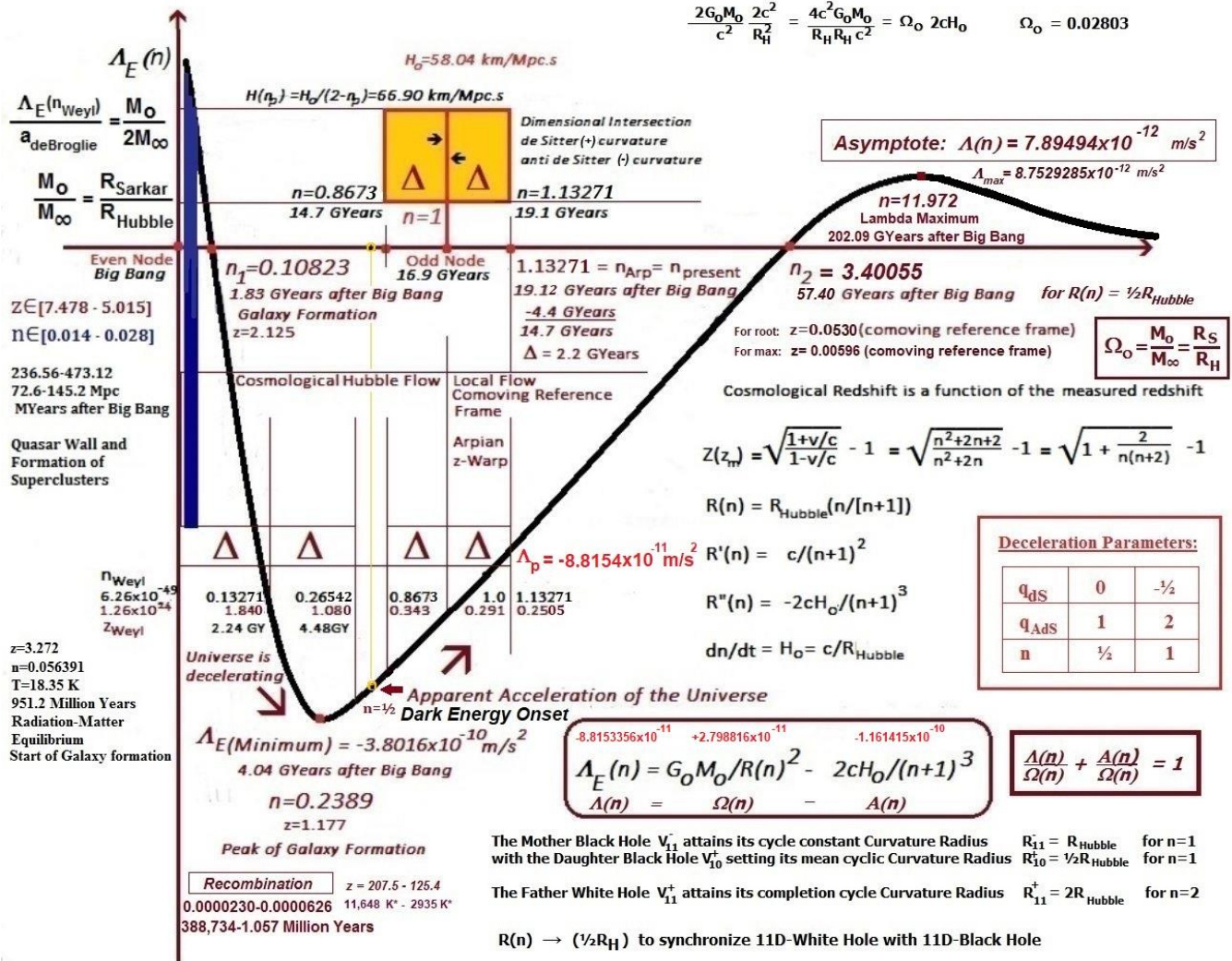



Any spacetime observer then measures the universe from two locations simultaneously; namely from the origin of the QBBS as a Big Bang witness and as a 'cosmic wave surfer' 'riding' not the compacted closed de Sitter boundary of the universe, but the open Anti de Sitter boundary of the refracted Lightpath of the higher dimensional electromagnetic monopolar Lightpath at the 'déjà vu' coordinate mirrored from the second universe, created by the intersection of the forward journey of the EMMR and both refracted and reflected from the boundary of the nodal Hubble event horizon.

A perfectly flat EPM universe emerges because the positive curvature of the gravitationally compacted 'baryonic' spacetime expansion cancels the negative curvature of the open hyperbolic spacetime in the Lightpath reflectivity of the 'dark mattered' spacetime contraction from the nodal  $H_0$  Hubble mirror of the QBBS parameters.

As the dS refractive recessional velocity continually decreases in the asymptotic evolution of the dS universe in its definition of the true Hubble event horizon; the reflective part will increase with a relative Doppler blueshift from the Hubble node of the protoverse to mimic an accelerating cosmology for the Big Bang observer looking backwards in time. This QBBS observer will measure a universe getting younger in time for completion of the Hubble cycle of a MBH 'heartbeat' oscillation  $n=1$  to  $n=2$ .

The 'cosmic wave surfer' moving with the recessional velocity of the AdS multiverse and with the boundary of the continually manifesting true Hubble event horizon will however understand that this observer experiences a co-moving cosmological Arpian redshift relative to the stationary Big Bang view.

The asymptotic expansion of the open EPM dS universe continues, but never reaches the nodal Hubble event horizon due to the negative curvature of the AdS cosmology. The experienced universe is so both open and closed in multidimensionality with the 'big crunch' solution of the cosmological formulations being circumvented in the nature of the AdS Lightpath.

As a half cycle defines the Lightpath between the even and odd nodes for the nodal Hubble event horizon with  $n=1$  in the halfway marker of the dark energy onset at  $n=1/2$ , resetting the nodal unitary displacement for the  $n$ -intervals  $[-1/2, +1/2]$  and  $[0/n_{ps}, 1]=[f_{ps}, H_0]$ ; resolves the 'horizon problem' with respect to the Lightpath communicating at lightspeed with its opposite radial coordinate in the reset image of the dark energy coordinate in the shadow universe of Khaibit at  $n=-1/2$ .

This relates to the AdS-CFT correspondence of Maldacena-Susskind and co-operators regarding a Holographic Universe cosmology and the Page curve bound in the Hawking Black Hole Information paradox.

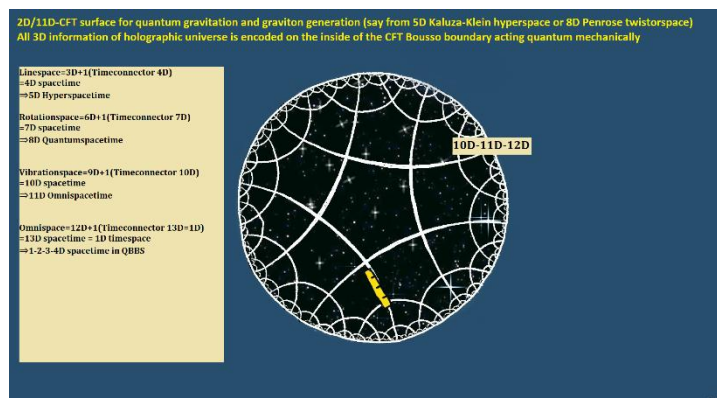

<https://youtu.be/klpDHn8viX8>

The Anti de Sitter AdS spacetime is negatively curved as 3-dimensional volumar behaving like a hologram. It is bounded by a 2-dimensional surface relating the graviton generating Conformal-Field-Theory CFT as the information matrix encoding the 3-dimensional holographic universe.

This 'Bousso bound' for a 3-dimensional spherical universe of hyperbolic negative curvature then is modelled as the 11-dimensional Witten mirror of the membrane bulk space in string-membrane theory in  $8+2=10$  membrane spatial dimensions with intermediate quantum wormhole-entangled mirror dimensions as a 5<sup>th</sup> Kaluza-Klein hyperspace surface dimension and an 8<sup>th</sup> Penrose-Twistor manifold dimension.

A 12<sup>th</sup> 'volumar-brane' 'Vafa' dimension, say as the 'outside' of the CFT "Bousso bound" then closes the multidimensional spectrum as a reversed time dimension rendering the 13<sup>th</sup> dimension for a mathematical continuation as a linespace dimension as equal to the null dimension of the timespace singularity of the Quantum Big Bang Singularity or QBBS and enables the 12<sup>th</sup> dimension of the Bousso-Vafa boundary to assume a physical realization as the 1<sup>st</sup> spacetime dimension from the Planck epoch transition from timespace into spacetime. The 12 dimensions so can be modelled to reduce to 3x4D hyperspace dimensions without time or as 4x3D spatial dimensions utilizing dimension counters 4, 7, 10 and  $13=1$  as time connector dimensions. In string-membrane theory 6 spatial dimensions are compactified in Calabi-Yau manifolds within a 4-dimensional spacetime and in 10-dimensional string bulk space or in 11-dimensional membrane bulk space.

The famous Hawking Black Hole Information paradox then addresses the fact that in classical physical theory and for Black Hole BH descriptions in General Relativity, the information absorbed by a Black Hole's gravity should become lost within the Black Hole and inclusive of the 'virtual' quantum pair partner quantum entangled with the 'materializing' matter-antimatter partner responsible for Hawking Radiation and causing a quantum mechanical loss of mass and heat for the BH.

One basic premise for this situation proposed by Hawking, is the independence of a BH from its formation and initial state of 0 entropy and that no information within the BH could be accessible from its outside. The evaporating BH so would lose information within its interior irreversibly by Hawking radiation.

The Hawking BH Information paradox then appears in its conflict with both classical physics and quantum mechanics in regard to conservation laws with respect to energy and momentum and the unitarity principle, demanding that the initial state of a quantum mechanical wave function evolving according to a unitary operator is preserved at any state of the wave function  $|\Psi(t_1)\rangle = U(t_1, t_2)|\Psi(t_2)\rangle$ .

As the unitary operator has an inverse, the reversal of the wave function should also always preserve the information expressed by the wave function of the system.

The paradox is resolved in quantum entanglement of the Hawking radiation coupled as a Hawking particle of positive mass-energy as Hawking radiation from the BH event horizon without with the absorbed Hawking antiparticle of say negative mass-energy within. Any escaping Hawking radiation so must conserve the energy-momentum balance by decreasing the mass of the emitting Black hole. Any BH event horizon within the dS universe is quantum entangled with the Hubble event horizon of the AdS Lightpath of the EMMI expanding wavefront of the universe for the multidimensional cosmology.

The AdS expanding wavefront can be called the 'Mother extremal Strominger BH' of the Maldacena-Susskind AdS-CFT correspondence of the Bousso-Witten-Vafa bound quantum entangled with the dS expanding wavefront of the dS universe as her daughter.

Considering the dS cosmology as a gravitationally compressed spacetime mirroring the AdS Lightpath as the 'Daughter extremal Strominger BH', the Hawking entropy would rise from the creation event of the QBBS until its dS Lightpath would encounter the halfway marker of  $n=1/2$  as the onset of Dark Energy and as the creation of a extremal BH event horizon as defined by the Page curve as a Quantum Extremal Surface or Manifold and as the maximum entropy coordinate for the time evolution of a Black Hole.

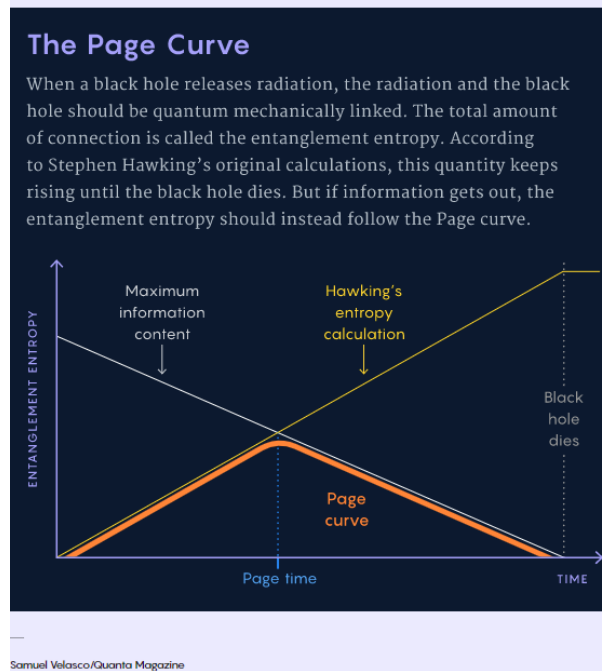

Past the maximum entanglement entropy, the negative mass-energy Hawking particles no longer are confined within the BH and become part of the spacetime outside of the BH, but within the CFT Bousso boundary. Considering the Strominger form of the dS and AdS cosmologies as eternal-extremal Black Holes, which do not Hawking radiate; the BH Hawking particles become ordinary positive mass-energy particles of the lower dimensional cosmology emitted from the QBBS-dS wave front quantum entanglement towards the Bousso-Witten CFT quantum mechanical inner boundary of the compressed spacetime.

The negative mass-energy BH Hawking particles manifest in imaginary Hawking-Wick time in the mirror image of the QBBS in the Khaibit shadow or mirror universe. But the imaginary Hawking-Wick event horizon is in physically real time as the dS-Bousso bound and so the Dark Matter contained in the compressed dS spacetime is subtracted as negative mass from the outer dS-Bousso bound in the mirror duality to balance the critical density for overall mass closure of the multidimensional cosmology.

The inner AdS-Bousso bound then emits positive mass-energy Hawking particles as the Dark Matter fraction not intersecting the baryonic matter and the outer AdS-Bousso bound matches this 'dark matter' as negative mass-energy Hawking particles not as Hawking radiation, but in the form of 'light matter' Vortex-Potential-Energy VPE or ZPE associated with the spacetime creation defined by the true Hubble node as the expanding wave front of the multidimensional quantum entangled multiverse. This imaginary time is also bounded as real time in the inner boundary of the Bousso-Witten-Vafa CFT quantum mechanical inner boundary of the uncompressed AdS spacetime in omnispacetime in 12-dimensional Vafa-time and as the reversal of the time arrow as the outer form of the CFT boundary.

The inner boundary of the dS-Bousso CFT boundary so emits and absorbs the mass-energy dynamics in energy-momentum conservation and continuity and in the form of the Einstein quintessence incorporating both baryonic and dark matter of the lower dimensional dS universe as the information contained in the de Sitter universe, bounded by its higher dimensional Anti de Sitter universe in an extremal BH communication between the AdS mother and the dS daughter universes.

The spacetime between the two spacetimes geometrically and topologically describes a region of spacetime exclusively occupied by dark matter as that part of the critical density not yet reached by the expansion of the compressed dS wavefront of the gravitationally retarded cosmology.

**Baryon Matter, Dark Matter and Dark Energy distribution in  $\Omega_{BM} + \Omega_{DM} + \Omega_{DE} = 1 = \Omega_o f(n) + \Omega_{DE}$   
 $\Omega_{DE} < 0$  for  $n < n_{DE=0}$  and  $\Omega_{DE} = 0$  for  $n = n_{DE=0}$  and  $\Omega_{DE} > 0$  for  $n > n_{DE=0}$**

The density ratio  $\rho_{BMUDM}/\rho_{critical} = M_o Y^n R_H^3 / M_H R_H^3 (n/[n+1])^3 = \Omega_o Y^n \{1+1/n\}^3 = \Omega_o f(n) = \Omega_{BM} \{1+1/n\}^3$

$\rho_{BMUDM}/\rho_{critical} + \Omega_{DE} = 1 = \Omega_o f(n) + \Omega_{DE} = \Omega_{BM} \{1+1/n\}^3 + \Omega_{DE}$

For  $\Omega_{DM} = \Omega_{BM} \{ (1 + 1/n)^3 - 1 \} = \Omega_o (1.618033)^{1.132712} \{ 5.67480 \} = \{ 0.048344 \} \{ 5.67480 \} = 0.274344$  and  
 $\Omega_{DE} = 1 - \Omega_{DM} - \Omega_{BM} = 1 - \Omega_{BM} \{ (1+1/n)^3 \} = 1 - 0.048344 \{ 6.67480 \} = 0.677313$  for the present time

**$\Omega_{BM} = 0.048344$  with  $\Omega_{DM} = 0.274344$  with  $\Omega_{DE} = 0.677313$**

For  $n < n_{DE=0}$  the quintessential DE fraction is negative and subtracted from the Dark Matter fraction.

The Dark Energy DE onset as a correlation between the scale factors  $a(n=1/2) = R(n, t)/R_H = n/[n+1] = 1/3$  and  $a(n=1) = R(n, t)/R_H = n/[n+1] = 1/2$  then synchronizes the intersection interval between the closed compressed dS spacetime and the uncompressed open AdS spacetime in the intersecting twinned universe in the interval  $[-1/2 | 0 | +1/2]$  as imaged half cycles as a full cycle  $[0+n_{ps}, +1]$  imaged in  $[-1, 0-n_{ps}]$ .

For the DE to be 0 the density ratio  $\rho_{BMUDM}/\rho_{critical} = 1$  describing the Sarkar mass seedling  $M_o$  to increase quintessentially by the BM-DM intersection, saturated at  $n=\sqrt{2}$  for constant  $\Omega_{BM}$  to the closure value  $M_H$  as  $\Omega_o=1$ .

$\Omega_o Y^n \{1+1/n\}^3 = 1$  for root  $n_{i+1} = n_i - f(n_i)/f'(n_i)$  by a Newton-Raphson approximation  
for  $f(n) = \Omega_o \exp[n \ln Y] \{1+1/n\}^3 - 1 = 0$  and  $f'(n) = \Omega_o \exp[n \ln Y] \{1+1/n\}^2 \{ \ln Y [1+1/n] - 3/n^2 \}$

For  $n_1=1/2$ ;  $n_2 = 1/2 - f(1/2)/f'(1/2) = 1/2 - (27\Omega_o Y^{1/2} - 1)/(9\Omega_o Y^{1/2} \{3 \ln Y - 12\}) = 1/2 - (-0.037323)/(-3.387457) = 0.488982$   
converging to  $n_{DE=0} = 0.489365... = 1/2 - 0.010635$  and as  $\Delta n/H_o = \Delta n R_H/c = \Delta t = 179.48$  million years as the quantum extremal surface wall for the Page Time in the resolution of the Hawking Information Paradox and as the transition period from the onset of the dark energy 8.258 billion years from the QBBS to 8.438 billion years as the scale factor  $a(1)=R(n)/R_H=1/2$ .

This synchronizes the nodal  $H_o=c/R_H$  frequency with the halfway marker for the AdS Lightpath  $nR_H/R_H=1/2$  meeting the dS Lightpath in the inflaton reversed and nodal mirror EMMR reflection.

For  $n=n_{ps}$  the mass-energy % distribution  $\Omega_o = \Omega_{BM} + \Omega_{DM} + \Omega_{DE} = (2.803 + 97.197)$  in  $(1.14 - 1.14) \times 10^{145}$   
 For  $n=0.014015$  the mass-energy % distribution  $\Omega_o = \Omega_{BM} + \Omega_{DM} + \Omega_{DE} = (2.822 + 97.178)$  in  $(1.06 - 1.06) \times 10^6$   
 For  $n=0.02803$  the mass-energy % distribution  $\Omega_o = \Omega_{BM} + \Omega_{DM} + \Omega_{DE} = (2.841 + 140,158.774 - 140,061.615)$   
 For  $n=0.10823$  the mass-energy % distribution  $\Omega_o = \Omega_{BM} + \Omega_{DM} + \Omega_{DE} = (2.953 + 3167.261 - 3070.214)$   
 For  $n=0.2389$  the mass-energy % distribution  $\Omega_o = \Omega_{BM} + \Omega_{DM} + \Omega_{DE} = (3.144 + 435.397 - 338.541)$   
**For  $n=0.489365$  the mass-energy % distribution  $\Omega_o = \Omega_{BM} + \Omega_{DM} + \Omega_{DE} = (3.547 + 96.453 + 0)$**   
 For  $n=0.49$  the mass-energy % distribution  $\Omega_o = \Omega_{BM} + \Omega_{DM} + \Omega_{DE} = (3.548 + 96.211 + 0.241)$   
**For  $n=1/2$  the mass-energy % distribution  $\Omega_o = \Omega_{BM} + \Omega_{DM} + \Omega_{DE} = (3.565 + 92.703 + 3.732)$**   
**For  $n=1$  the mass-energy % distribution  $\Omega_o = \Omega_{BM} + \Omega_{DM} + \Omega_{DE} = (4.535 + 31.748 + 63.717)$**   
**For  $n=1.132712$  the mass-energy % distribution  $\Omega_o = \Omega_{BM} + \Omega_{DM} + \Omega_{DE} = (4.834 + 27.434 + 67.732)$**   
 For  $n=\sqrt{2}$  the mass-energy % distribution  $\Omega_o = \Omega_{BM} + \Omega_{DM} + \Omega_{DE} = (5.536 + 22.004 + 72.460)$   
 For  $n=2$  the mass-energy % distribution  $\Omega_o = \Omega_{BM} + \Omega_{DM} + \Omega_{DE} = (5.536 + 3.924 + 90.540)$   
 For  $n=234.4715$  the mass-energy % distribution  $\Omega_o = \Omega_{BM} + \Omega_{DM} + \Omega_{DE} = (5.536 + 0.071 + 94.393)$

The particles within the compressed dS ‘daughter BH’ spacetime so can be considered to be Hawking positive mass-energy particles and the particles without this space time but within the AdS spacetime can be said to be the Hawking negative mass-energy particles; the particle pairs increasing the overall entropy of the dS universe until the maximum entropy state is attained.

From this maximum entropy state as the Page time for the dark energy onset at cycle time coordinate  $n=1/2$  and imaged in imaginary time at  $n=-1/2$ , the overall entanglement entropy begins to decline. Then the two imaged half cycles define a full cycle  $|-1/2| + |1/2| = 1$  for  $n=1$  and the time coordinate the scale factor  $a = R(n=1)/R_H = n/[n+1] = 1/2$  has reached the Page time coordinate of the entanglement entropy maximum.

The refractive-reflective duality of the EMMR Lightpath of the AdS cosmology for the Page time and the onset of a decrease in the entanglement entropy so initiates a change of the geometric topology of the wormhole curvature connectivity between the dS and the AdS universes.

The hyperbolic open dS spacetime manifests its boundary of closure in continuation as the Bousso inner boundary as the dS opening of the connecting wormhole bridge and the outer boundary cancels the reflective inner boundary of the hyperbolic AdS spacetime opening of the EPR wormhole bridge and to manifest its outer Bousso boundary as the refractive boundary of closure for the higher dimensional AdS Lightpath continuation at the other end of the wormhole connectivity.

The Minkowski flat space metric  $ds^2 = -dt^2 + dx^2 + dy^2 + dz^2$  is equivalent to the 4-dimensional Euclidean metric  $ds^2 = d\tau^2 + dx^2 + dy^2 + dz^2$  in rotation Wick space as Hawking’s imaginary time  $t=it$

Hawking’s imaginary time as a Wick time of rotation space relates the  $[-1/2, +1/2]$  n-cycle time interval of the twinned universe to the creation of the Quantum Extremal Surface as the n coordinates  $n = i^2 H_0 t = -1/2$ , in the shadow universe Khaibit and  $n = H_0 t = +1/2$  in the universe of the instanton-inflaton QBBS. The rotation space for the dS cosmology so takes the form of the holographic boundary between 3D-linespace as 4D-spacetime and a 4-dimensional hyperspace without time as a 5D hyperspacetime.

That quantum entanglement is an effect of wormholes has been proposed by Susskind and Maldacena in 2013. Maximum quantum entanglement between two spatially separated Black Holes, say the AdS distant mother and the dS distant daughter, is achieved in EPR Einstein-Podolsky-Rosen bridge pair connections or wormholes.

{ [\[1306.0533\] Cool horizons for entangled black holes \(arxiv.org\)](#)}

The information in the dS cosmology so is wormhole tunneled to the AdS cosmology since the QBBS and the creation event with either the dS universe or the AdS universe enabled to become a simulation of the other and as discovered by Hartman and Tajdini in 2019 as the path integral for both classical and quantum gravitation.

{ [\[2011.09043\] Replica wormholes for an evaporating 2D black hole \(arxiv.org\)](#)}

In Quantum Relativity, both extremal Black Holes in dS and AdS are physically real and separated by a 5D-8D or 11D hyperspacetime AdS-CFT quantum mechanical correspondence and so a quantum gravitational boundary.

The nonlocality of the AdS-CFT duality so intrinsically links to the mirror duality of the string-membrane cosmology in changing the quantum geometry of the wormhole connectivity in the positive curvature of the holographic universe closed by the Bousso-Witten-Vafa CFT quantum bound yet being open with negative curvature in wormhole 'saddle points' as replica wormholes changing in inverse proportionality in regard to the entanglement entropy with its native BH Maldacena-Susskind pairing.

The bulk spacetime of the cosmologies so is fundamentally not metric based but integrates spacetime quanta in the form of the QBBS minimum spacetime configuration as the Weyl-wormhole of the EpsEss supermembrane derived from the Dirac string and the Dirac magnetic monopole.

The spacetime volumar  $2\pi^2 r_{ps}^3$  so is compressed in the spacetime volumar  $4\pi r_{4D}^3/3$  in the Source energy per unit volume  $E_{VPE-ZPE} = 4\pi E_{ps}/\lambda_{ps}^3$  for  $r_{4D} = \sqrt[3]{\{3\pi/2\}} r_{ps} = 1.67654 r_{ps}$  in the surface area modulation  $6\pi^2 = 3\pi \cdot 4\pi/2$  in the dimensional reduction of the sphericity of the 3-ball  $V_4 = \frac{1}{2}\pi^2 R_4^4$  as a 3-dimensional surface  $dV_4/dR_4 = 2\pi^2 R_3^3$  to the 2-ball  $V_3 = 4\pi R_3^3/3$  as the energy per unit volumar spacetime quantum for the wormhole integration of the multidimensional cosmology.

The quantized spacetime so becomes a summation of Susskind-Maldacena integrated wormhole quanta enabled to connect time-parallel extremal Strominger black holes as a closed dS universe and an open AdS universe as an Einstein-Podolsky-Rosen bridge. The region of spacetime connected by the two wormhole faces then describes the dark wormhole matter not intersecting the baryonic mass seed and is defined in the extremal quantum surface of the Page Time.

## A wormhole supermembrane spacetime continuity configuration from timespace

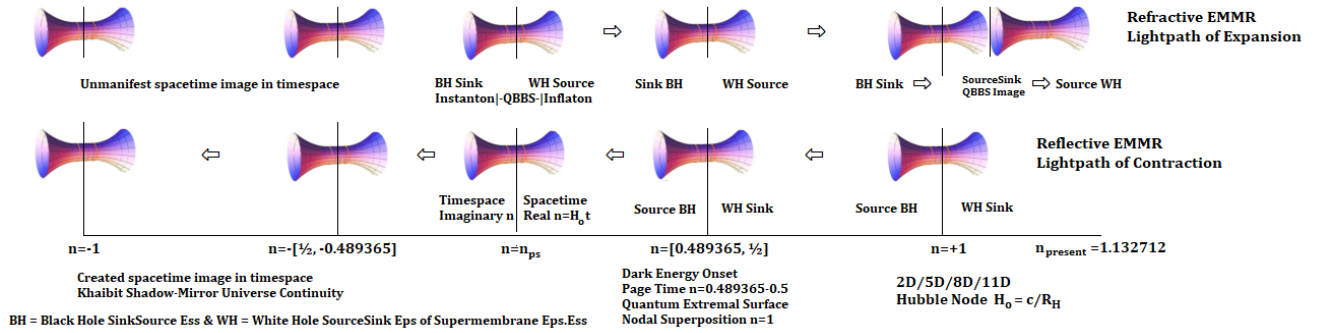

## The Great Black Hole Information Escape

As black holes radiate, information appears to be lost. But this can be avoided if the “entanglement entropy” of the radiation rises then falls. Recent calculations have shown how this happens via a “quantum extremal surface” that appears just inside the black hole’s event horizon. Everything inside of this surface is suddenly not part of the black hole. Exactly how this happens, and what it all means, is still an enormous mystery.

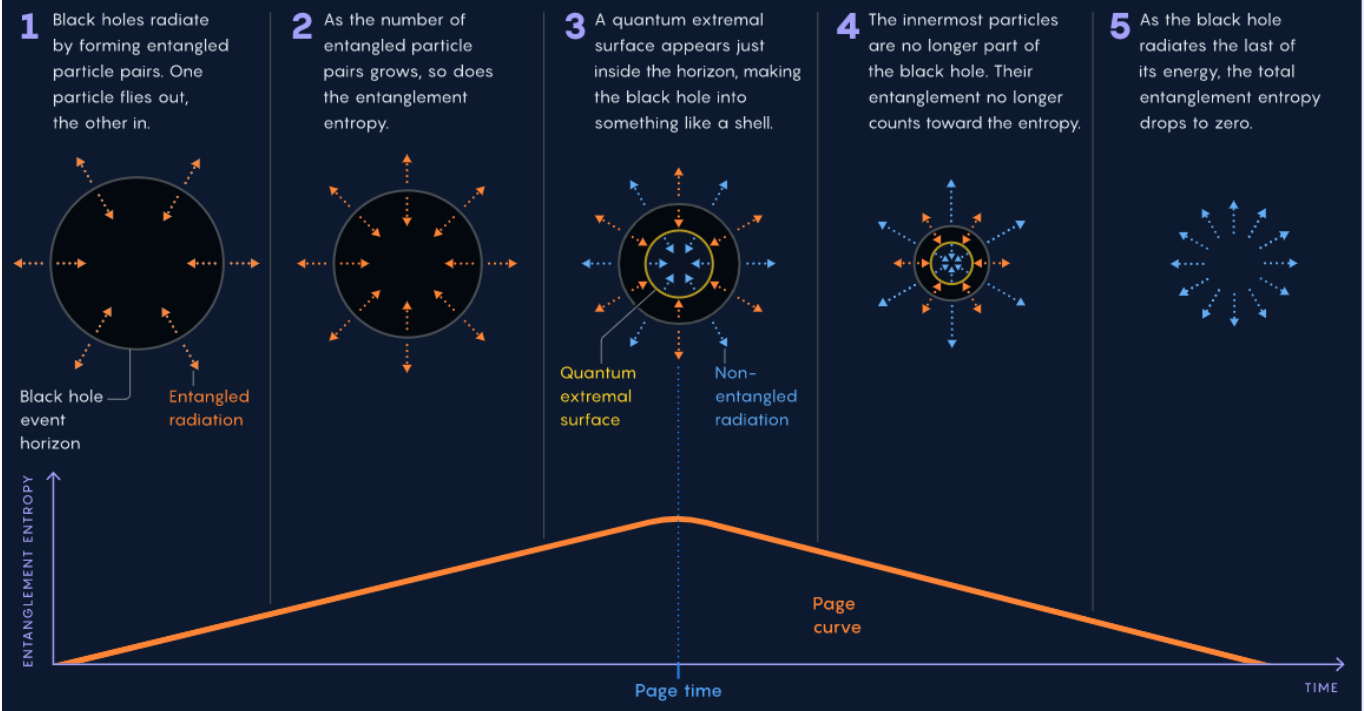

2D/11D-CFT surface for quantum gravitation and graviton generation (say from 5D Kaluza-Klein hyperspace or 8D Penrose twistorspace)  
 All 3D information of holographic universe is encoded on the inside of the CFT Bousso boundary acting quantum mechanically

Linespace=3D+1(Timeconnector 4D)  
 =4D spacetime  
 ⇒5D Hyperspacetime

Rotationspace=6D+1(Timeconnector 7D)  
 =7D spacetime  
 ⇒8D Quantumspacetime

Vibrationspace=9D+1(Timeconnector 10D)  
 =10D spacetime  
 ⇒11D Omnispacetime

Omnispacetime=12D+1(Timeconnector 13D=1D)  
 =13D spacetime = 1D timespace  
 ⇒1-2-3-4D spacetime in QBBS

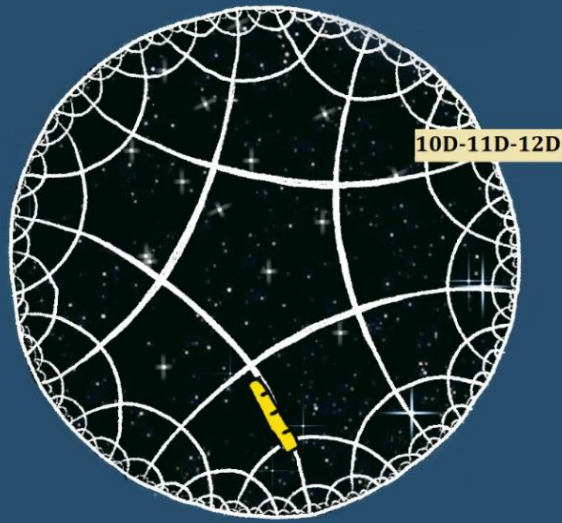

[The Most Famous Paradox in Physics Nears Its End | Quanta Magazine](#)

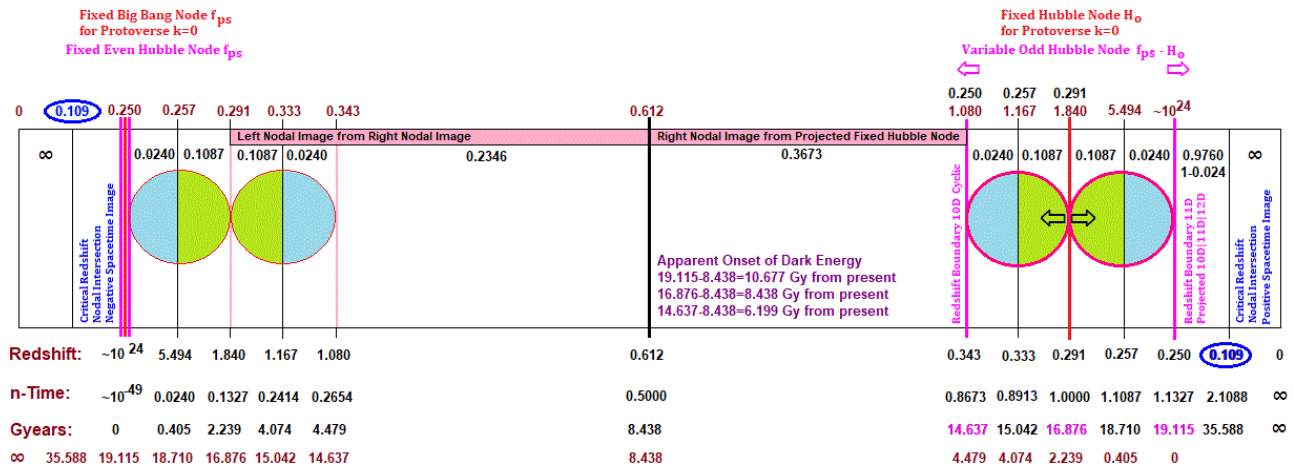

Universe Expansion into the Projected Future  
 Big Bang Genesis Observer for Increasing Redshift  
 ⇒ Measured by Big Bang Genesis-Time Observer



Universe Expansion into the Projected Past  
 Cosmic Wave Surfer for Increasing Redshift  
 Measured by Earth-Time Observer ⇐

Depending on the number of cycles defined by the QBBS boundary initial parameters, further universes are born from the protoversal seed depending on the completion of the cycle counts and the resetting of the nodal Hubble parameters at the end of the cycle counts for respective universes from the protoversal seed.



After 234.4715 Cycles, the n-cycle coordinate will have reached a value of  $234.15/235.15 = 0.99575$  or 99.575 % of the nodal Hubble radius and at a time coordinate of  $t=234.4715/H_o = 234.4715R_H/c$  or  $1.2486936 \times 10^{20}$  [s]\* or  $3.957 \times 10^{12}$  years or about 4 trillion years.

Models of cosmology project this timeframe to result in a 'heat death' of the lower dimensional universe in its exhaustion of nuclear fuel required for continual star formation. But at his time, the second universe created as a cyclic second QBBS 233.4715 cycles earlier, will have attained an almost equal radial extent at the 233.4715 cycle coordinate and the protoversal seedling will quantum tunnel as the 1st universe into the second universe.

The reducing quantum wall of displacement for a quantum tunnel as the 'thickness' of the wall is so replaced in the nodal extent of spacetime as  $234.4715 - 233.4715 = 1 = 235.4715 - 234.4715$ .

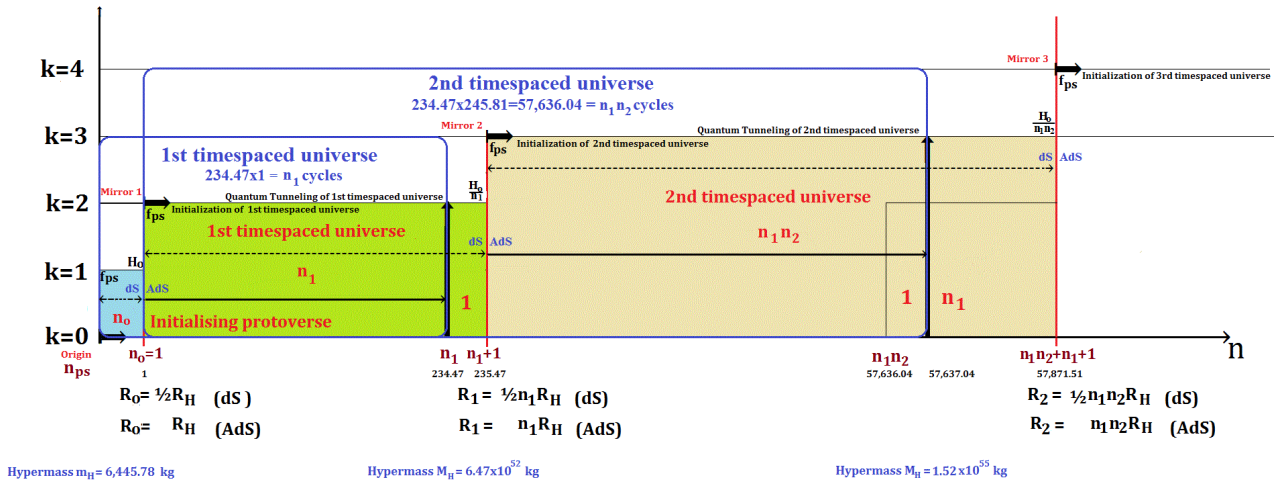
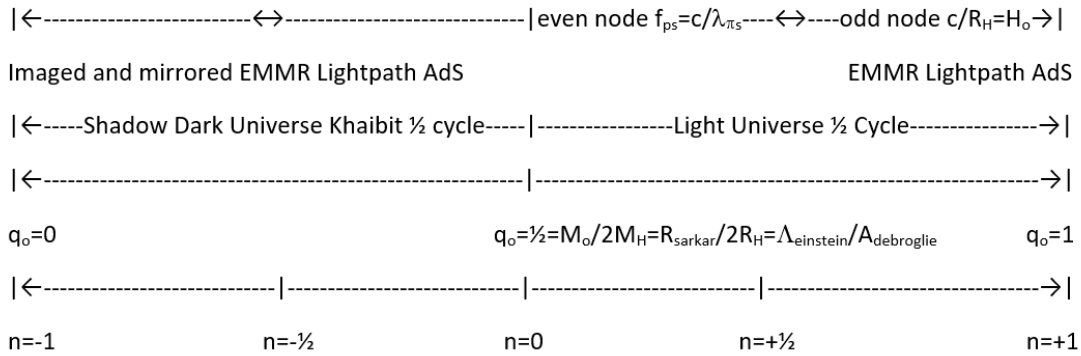

Radius of Curvature  $r(n)$  with Salefactor  $1/a=1+1/n$  in  $dS$  as a function of cycletime coordinate  $n$

$$r(n) = r_{\max} \left( \frac{n}{n+1} \right) m^* \quad \text{and} \quad n = H_0 t$$

The volume of the 4-D spacetime can however be found by integrating the surface area S.A. via arclength  $L$ , with  $L$  being an intrinsic parameter of the 3-D surface.  $dL=r \cdot d\theta$

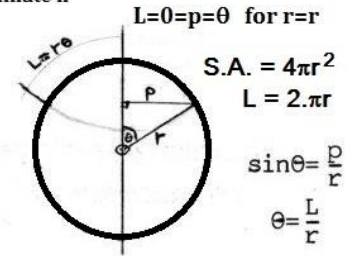

$$V_{\text{Universe}} = \int_0^{r\pi} 4\pi r^2 dL = 2\pi^2 r(n)^3 \quad \text{for a local spheroidicity}$$

$$4\pi \int_0^\pi r^3 \sin^2 \theta d\theta = 4\pi r^3 \int_0^\pi \frac{1}{2} (1 - \cos 2\theta) d\theta = 2\pi^2 r(n)^3 \quad \text{for the asymptotic 4/10D dS 'flatness' cosmology within the nodal Hubble 5/11D AdS Universe}$$

This classical macrovolumar is quantized in the microvolumar quantum of the Unified Field in  $8\pi$  radians or  $840^\circ - (-600^\circ) = 1440^\circ$

$$\begin{aligned} & \frac{1}{4}\pi \int_{-600^\circ}^{840^\circ} \{ \sin(\frac{1}{2}[3x]) - \cos(\frac{1}{4}[3x]) \}^2 dx = \frac{1}{4}\pi \int_{-10\pi/3}^{14\pi/3} \{ \sin^2(3x/2) + \cos^2(3x/4) - 2\sin(3x/2)\cos(3x/4) \} dx \\ & = \frac{1}{4}\pi \int_{-600^\circ}^{840^\circ} \{ \frac{1}{2}(1 - \cos[3x]) + \frac{1}{2}(1 + \cos\frac{1}{2}[3x]) - \sin\frac{1}{2}[9x] - \sin\frac{1}{4}[3x] \} dx \quad \left\{ \begin{array}{l} \text{by classical volumar of revolution (vor)} \\ V_{\text{vor}} = \int \pi y^2 dx \quad \text{for } y=r \end{array} \right\} \\ & = \frac{1}{4}\pi \left[ \theta - \sin[3x]/6 + \sin\frac{1}{2}[3x]/3 - 2\cos\frac{1}{2}[9x]/9 - 2\cos\frac{1}{2}[3x]/3 \right]_{-10\pi/3}^{14\pi/3} = \frac{1}{4}\pi(8\pi) = 2\pi^2 \end{aligned}$$

The amplitude for the universal wavefunction becomes proportional to the quantum count of the space occupancy of a single spacetime quantum and as source energy (VPE or Vortex Potential Energy) quantum and as a consequence of the preinflationary supersymmetry of the  $F(x) = \sin x + \sin(-x) = 0$  wavefunction defining this singularity (symbolised as the symbol for infinity).

A higher dimensional surface is Moebian connected to differentiate the quantum mechanical 'boundary' for the quantum tunneling of the macrocosmos as a magnified holofractal of the well understood microquantumization.

It then is the experienced and measured relativity of time itself, which becomes the quantum wall, with the 'reducing thickness' of the quantum boundary correlating with the evolution of the multiversal structure in the phase shifted time intervals defining the individual universes.



<p style="text-align: center;"><b>Khaibit Shadow-Mirror</b> <b>Universe de Abba</b></p> <p style="text-align: center; font-size: small;">Remains fully dark energized until <math>n = -\frac{1}{2}</math> from Hubble Inflaton node <math>n = -1</math></p>	<p style="text-align: center;"><b>Riemann Universe</b> <b>Universe de Baab</b></p> <p style="text-align: center; font-size: small;">Remains fully light energized from <math>n = +\frac{1}{2}</math> from Hubble Anti-Inflaton node <math>n = +1</math></p>
---	---

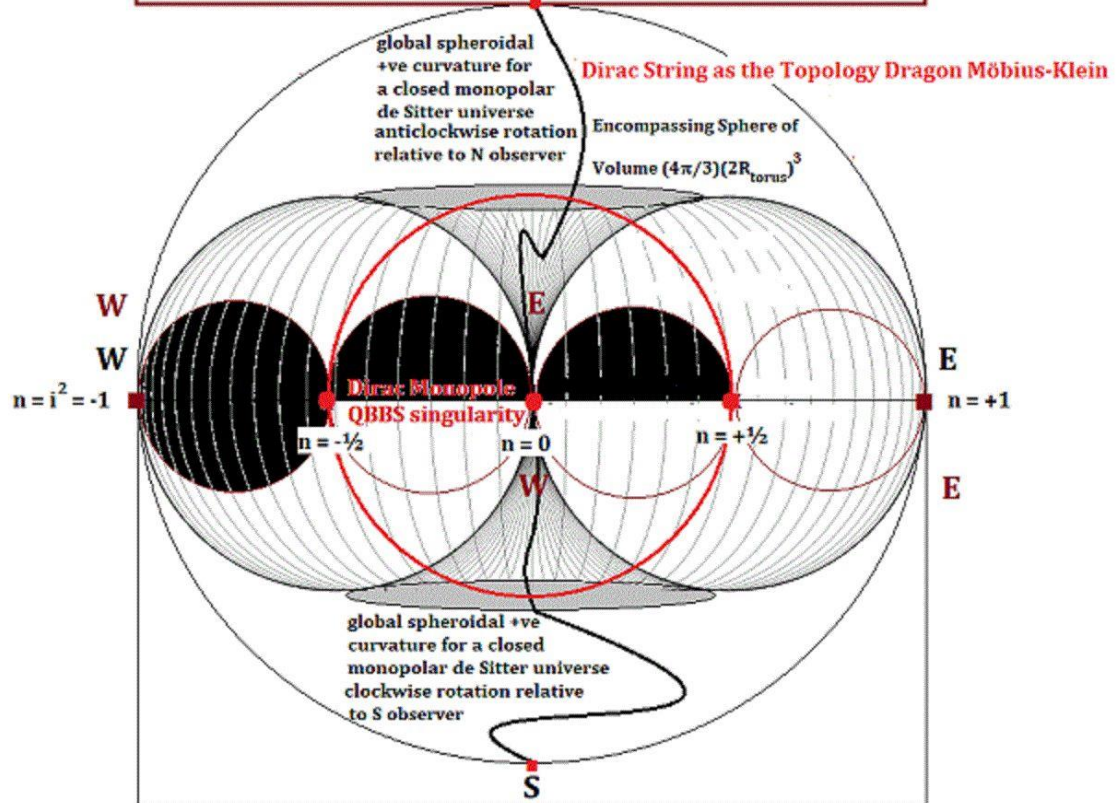

Radius $R_{\text{torus}}$	Radius $R_{\text{torus}}$	Radius $R_{\text{sphere}} = 2 R_{\text{torus}}$
$t_{\text{ALGO}} = n_{\text{ps}} = \lambda_{\text{ps}}/R_H = 6.259 \times 10^{-49}$		$1.775 \times 10^{-13} = t_{\text{ps}}^2/t_{\text{ALGO}} = t_{\text{ALGO}}$
$t_{\text{OPL}} = 2\pi e/c^3 = \sqrt{\alpha} t_{\text{PL}} = 3.739 \times 10^{-44}$		$2.972 \times 10^{-18} = t_{\text{ps}}^2/t_{\text{OPL}} = t_{\text{OPL}}$
$t_{\text{PL}} = 2\pi R_{\text{pl}}/c = 4.377 \times 10^{-43}$		$2.539 \times 10^{-19} = t_{\text{ps}}^2/t_{\text{PL}} = t_{\text{PL}}$
$t_{\text{MO}}^{\text{ec}} = 2\pi R_{\text{MO}}/c = 5.124 \times 10^{-42}$		$2.169 \times 10^{-20} = h/E = t_{\text{MO}}^{\text{ec}}$
$t_{\text{MO}}^{\text{max}} = 2\pi R_{\text{MO}}/c = 1.537 \times 10^{-40}$		$7.229 \times 10^{-22} = t_{\text{ps}}^2/t_{\text{MO}} = t_{\text{MO}}^{\text{min}}$
$t_{\text{XL}} = 2\pi R_{\text{XL}}/c = 2.202 \times 10^{-39}$		$5.046 \times 10^{-23} = t_{\text{ps}}^2/t_{\text{XL}} = t_{\text{XL}}$
$t_{\text{EC}} = 2\pi R_{\text{EC}}/c = 6.618 \times 10^{-34}$		$1.679 \times 10^{-28} = t_{\text{ps}}^2/t_{\text{EC}} = t_{\text{EC}}$
$t_H = G_o M_o t_{\text{ps}}/R_H c^2 = 4.672 \times 10^{-33}$	$t_H = \sqrt{\alpha} t_{\text{ps}} = 2.847 \times 10^{-32}$	$3.902 \times 10^{-30} = t_{\text{ps}}/\sqrt{\alpha} = t_H$
		$2.378 \times 10^{-29} = R_H c^2 t_{\text{ps}}/G_o M_o = t_H$

Timespace	Higgs Boson Vacuum	Spacetime
	$t_{\text{ps}} = 2\pi R_{\text{ps}}/c = 3.333 \times 10^{-31}$	

End of Introduction to:

## **Dirac's Magnetic Monopole and the Energy Density of the Universe from Dark Matter with Dark Energy - A Cosmology of Initial Boundary Conditions**

I: Introduction to a Multidimensional Relaxation Cosmology for a 'Hubble Tension' in Quantum Relativity with Hawking's Information Paradox Resolution.....(12-44)  
II: Foreword – Dirac's String-Monopole Transformation.....(45-46)  
III: The Creation of Dirac's Quantum Big Bang in Spacetime from Timespace.....(47-66)  
IV: The Dark Energy coupled to the Light Energy of a Shadow-Mirror Universe.....(67-81)  
V: The Higgs-Planck False Vacuum and the Temperature Gradient for the QBBS Cosmology.....(82-97)  
VI: The Ylemic Universe and Quantum Gravitation from Superbrane Parameters.....(98-123)  
VII: A Synthesis of  $\Lambda$ CDM with MOND in a Universal Lambda Milgröm Deceleration.....(124-136)  
VIII: A Revision of the Friedmann Cosmology and Emergent Gravity in a Hypermass Multiverse.....(137-178)  
IX: Ylemic Gluon-Quark-Plasma Protostars as Vortex QBBS Energies.....(179-198)  
X: Primordial Neutron Decay from Higgs Boson – RMP/DM Quantum Geometry.....(199-202)  
XI: Initial Boundary Conditions for Matter-Antimatter Asymmetry.....(203-222)  
XII: The Gravitational Constant, the Alpha Finestructure Constant and the GUT-Monopole.....(223-234)  
XIII: The Inflaton and the Grand Unification Symmetry in a Transformation of Supermembranes.....(235-265)  
XIV: The Quantum Relativistic Monopolar Electron.....(266-314)  
XV: The Birth of the Universe in Space and Time from Physicalized Universal Consciousness.....(315-343)  
XVI: Quantum Consciousness in the Penrose-Hameroff Model.....(344-353)  
XVII: Epilogue: God Reborn - The Birth of God as a Superbrane - A Story of Intelligent Design and the Creation of the Quantum Universe in the Uniphyscon of Quantum Entangled Omnispace.....(354-366)

[Dirac's Magnetic Monopole And The Energy Density Of The Universe From Dark Matter With Dark Energy | Cosmogogenesis - Library of Akbar Ra in Alexandria Thuban \(cosmosdawn.net\)](http://cosmosdawn.net)

[Anthony P Bermanseder - Academia.edu](http://Academia.edu)

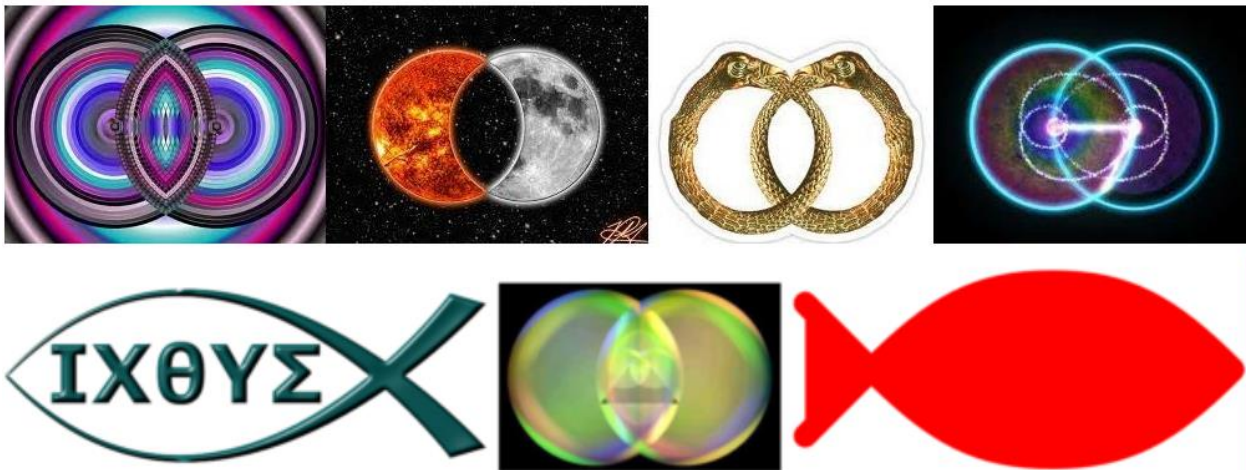

## **II: Foreword – Dirac’s String-Monopole Transformation :**

Paul A.M. Dirac said in his 1931 paper addressing his work on the quantization of electric charge in connection with the magnetic charge of a magnetic monopole:

*“The theory leads to a connection, namely,  $[eg_0 = hc/4\pi]$ , between the quantum of magnetic pole and the electronic charge. It is rather disappointing to find this reciprocity between electricity and magnetism, instead of a purely electronic quantum condition such as  $[hc/2\pi e^2]$ .”*

In his 1948 paper Dirac emphasized his belief in magnetic monopoles:

*“The quantization of electricity is one of the most fundamental and striking features of atomic physics, and there seems to be no explanation for it apart from the theory of poles. This provides some grounds for believing in the existence of these poles.”*

Then in 1978, Dirac expressed his disappointment as to the apparent unreality of magnetic monopoles and the physical importance of the electromagnetic finestructure constant alpha:

*“...[the theory]...did not lead to any value for this number value  $[\alpha^{-1} \approx 137]$ , and, for that reason, my argument seemed to be a failure and I was disappointed with it.”*

*“The problem of explaining this number  $hc/2\pi e^2$  is still completely unsolved. Nearly 50 years have passed since then. I think it is perhaps the most fundamental unsolved problem of physics at the present time, and I doubt very much whether any really big progress will be made in understanding the fundamentals of physics until it is solved.”*

Ref: [Dirac, P.A.M.](#) (September 1931). "Quantized Singularities in the Electromagnetic Field." Proceedings. **133** (821): 60–72. [Bibcode:1931RSPSA.133..60D](#). [doi:10.1098/rspa.1931.0130](#).

1. Dirac PAM. Quantized singularities in the electromagnetic field. Proc R Soc Lond A. 1931; 133: 60-72.
2. Dirac PAM. The theory of magnetic poles. Phys Rev. 1948; 74: 817-830.
3. Dirac PAM. The monopole concepts. Int J Theor Phys. 1978; 17: 235–247.
4. <https://arxiv.org/pdf/1810.13403.pdf>



# Scientists Create Synthetic Dirac Monopole

October 17, 2016 - by lastscience

**For the first time ever, physicists have created and photographed synthetic magnetic monopoles by engineering an environment that mimics a monopole's magnetic field in a cloud of rubidium atoms.**

In 1931, the English theoretical physicist Prof Paul Dirac predicted that the north and south poles of a magnet could exist independently and behave like electric charges.

Despite experimental searches since then no observation of a naturally-occurring magnetic monopole – a magnetic particle possessing only a single, isolated pole – has yet been confirmed.

In 2009, Finnish researchers published theoretical results demonstrating a method to create Dirac monopoles in a Bose–Einstein condensate, an extremely cold atomic gas tens of billionths of a degree warmer than absolute zero.

The idea involves using external magnetic fields to rotate the atomic spins. A Dirac monopole forms in the condensate because of the spin rotation.

This method was adopted by a team of physicists, led by Prof David Hall of Amherst College, in creating the synthetic magnetic monopole.

After resolving many technical challenges, Prof Hall and his colleagues were rewarded with photographs that confirmed the monopoles' presence at the ends of tiny quantum whirlpools within the ultracold gas.

"The result proves experimentally that Dirac's envisioned structures do exist in nature, even if the naturally occurring magnetic monopoles remain at large," said Prof Hall, who is the senior author of a paper published in the journal *Nature*.

"The creation of synthetic electric and magnetic fields is a new and rapidly expanding branch of physics that may lead to the development and understanding of entirely new materials, such as higher-temperature superconductors for the lossless transmission of electricity."

The discovery provides a stronger foundation for current searches for magnetic monopoles that have even involved the famous Large Hadron Collider at CERN.

"Our achievement opens up amazing avenues for quantum research. In the future, we want to get even a more complete correspondence with the natural magnetic monopole," said co-author Dr Mikko Möttönen of Aalto University.

In the future, physicists will concentrate on more in-depth research into the structure of a synthetic magnetic monopole. They are also interested in the dynamics of monopoles and their interactions with other synthetic particles

One interesting idea involves trying to create a monopole that is not bound to a whirlpool in the same way as is the Dirac monopole. This type of structure could possibly describe a natural magnetic monopole in even more detail. [Scientists Create Synthetic Dirac Monopole - Popular Science Part](#)

### III: The Creation of Dirac's Quantum Big Bang in Spacetime from Timespace

The origin and nature of the universe has been a question of inquiry since the beginnings of sentient life forms experiencing themselves in a variety of forms and degrees of being self-aware.

Many cosmological models have and are being constructed from the beginnings of speech and sound and geometric symbolism to words and written record keeping in parchments, scrolls, paper, manuscripts, and the digitalization of libraries.

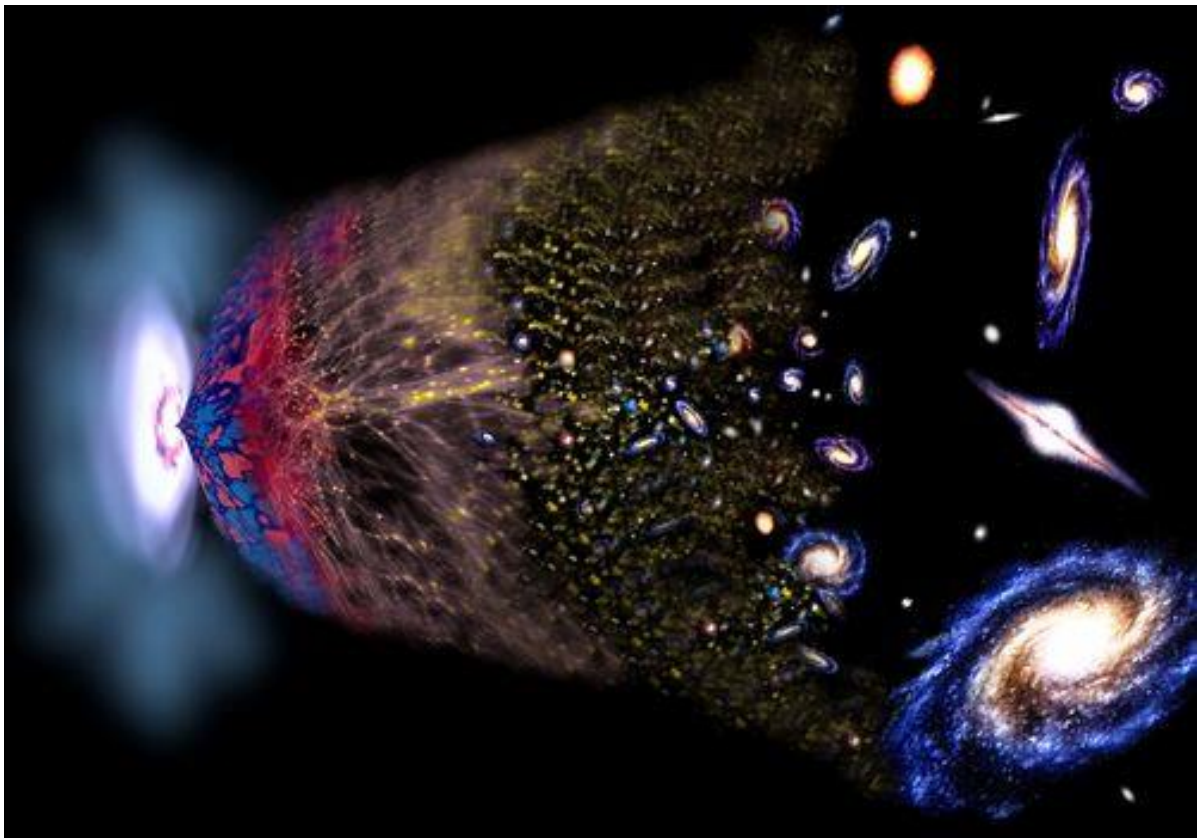

The Big Bang model for the creation of the universe

In the journey through the history of planet earth in time, the models created and composed to explain this history and the encompassing history of the universe itself, have attained a nexus point of comprehension and understanding to enable the planetary civilization on earth to collectivize and universally share its information basis with the overall universe.

A universal civilization potential can then be realized, by substituting an older historical timeframe of Universal Political Correctness by the 'Uniphyscon' or 'Universal Physicalized Consciousness' and as a synonym for a new historical timeframe and timespace as the generator of spacetime.

Timespace differs from spacetime in that time can exist without space as a simple count of mathematical point singularities or frequency permutation states in the case of particular modular dualities relating the mathematically abstract inversion properties of numbers to the physicalizations of the frequency states as inverse time to the period of oscillatory physical systems, such as a world defined in energy and its mathematical representations modelling the physical reality.

The universe was born from a mathematical singularity, known as a quantum fluctuation creating space and time in a minimized spacetime parameter configuration known as the Quantum Big Bang Singularity or QBBS. This quantum fluctuation is defined as the energy potential of a Zero-Point Planckian Quantum Harmonic Oscillator and as a minimum displacement configuration in a QBBS timespace and can also be termed as the 'bounce of the Planck length' as this minimum length any displacement defined in space can have.

It was this 'bounce' of timespace which formed the required original boundary conditions for the universe to be born in spacetime in the coupling of this 'instant in timespace' called an instanton and coupled to an 'instant in space' as the inflaton.

The QBBS then defined the concept of multidimensional spacetime in a dual action of a lower dimensional universe becoming embedded in a higher dimensional universe as effect of the inflaton utilizing the boundary condition of the instanton to manifest a parallel cosmology in the lower- and higher dimensional spacetimes.

This minimum spacetime configuration of the instanton-inflaton parameter space coupling is defined as a parameter space of the QBBS and containing other mathematical abstract point spaces such as symbolic representations known as fundamental constants and elementary mathematical relationships between numbers and equations of different degrees of interwovenness and complexity.

All entities in the QBBS parameter space shared a common origin in the abstraction of an encompassing data collective, which can be called the plenum or world of Information-Energy.

This world existing before the QBBS, so defines a notime in nowhere, where the concept of order precedes the concept of time in its independence of duration or time intervals; but where event B cannot occur before event A has occurred and independent from how far apart events A and B would be in an existing spacetime.

As time and space became manifest with the universe in the QBBS, the abstract entities emerging from it did not exist in the form of the QBBS parameter spacetime, but in the QBBS timespace.

This QBBS parameter timespace can be described as a prior realm of abstract mathematical definition and algorithmic identities and as a mirror universe awaiting its own metaphysical creation and manifestation through the emergence of particular data collectors and information gatherers within a then existing spacetime. The universal data collectors would evolvingly become self-aware in universal physicalized consciousness to utilize the abstract entities from the plenum of the information world to connect the spacetimed universe with the time spaced mirror universe.

As the mirror of the timespace was also a mirror of the spacetime, it could and would image all particulars of the physical universe in global and local parameters into Khaibit, the shadow of the physical universe as the mirror universe of the QBBS parameter spacetime.

This scenario required a medium of super-universal communication to connect the physical universe with Khaibit as its metaphysical shadow and mirror universe.

The medium for the super-universal communication took the form of quantum entangled universal physicalized consciousness and where this 'QE of the Uniphyscon' enabled the two worlds to blend and merge from the platform of an old timespace configuration into a form of a new spacetime configuration. The difference between the old form and the new form is that the old form began in time to create space and that the new form will be able to start from the space to create time.



The implication is that the old spacetime could not manipulate the interdependency of space and time, such as the initial boundary conditions defined in the QBBS, including the invariance of the 'speed of light  $c$ ' as a limit for velocity and the acceleration of any material object could achieve.

This dependency found in the natural laws was a consequence of the spacetime matrix beginning with time as the first and generating dimension and not with space as the generator dimension. In the old world the time dimension generated three expanding space dimensions with an additional six twistor space dimensions, strongly associated with the first-time dimension for a 10-dimensional string spacetime.

The twistor dimensions are different from the expanding time dimensions in that the twistor dimensions remain independent from space, except for their minimum spacetime configuration of forming little curls or circles around the time dimension.

In the new world, the first-time dimension will exchange with the 10<sup>th</sup> string dimension to change the old starting 1<sup>st</sup> time dimension into the 1<sup>st</sup> space dimension and opening up the 4<sup>th</sup>, previously curled up string dimension as a new space dimension.

This will transform the old universe of 4-dimensional flat Minkowski spacetime into a new universe, defined physically as a 5-dimensional flat Kaluza-Klein hyper-spacetime.

In the old world, the fourth expanding time dimension formed the boundary for an expanding universe, but in the new world, the 10<sup>th</sup> dimension will be the endpoint time dimension as a new boundary for the universe and connecting a new mirror of the 11<sup>th</sup> dimension to the mirror universe Khaibit as the inside of the boundary of the 10<sup>th</sup> dimension.

The outside of the Witten membrane spacetime mirror will be the inside of Khaibit as a 12<sup>th</sup> dimensional Vafa spacetime forming a spacetime perfect image of the inside of the 10-dimensional spacetime of the universe. The timespace of the QBBS generator will so become equivalent to the spacetime of the QBBS evolutionary path in the form of information exchange across the boundary of the Witten membrane mirror of the 11<sup>th</sup> dimension.

The end result will be a holographic multiverse in 12 dimensions and where the 11-dimensional membrane mirror will become the universal data collector as a root-reduced two-dimensional and two-sided Klein bottle manifold, yet one-sided as a Möbian connector having effectively doubled the old spacetime universe in 10 dimensions of the 4-dimensional hyperspace with a 6-dimensional twistor space and the 11<sup>th</sup> dimension as the new shared time dimension between Klein as Möbius and Khaibit.

The two sidedness of Klein so is defined in the new time dimension as a 10-dimensional string space of 4 hyperspace dimensions with 6 quantum space dimensions to bridge the difference to the 11-dimensional membrane space as the 10<sup>th</sup> spacetime dimension connecting as a brane space to the 11<sup>th</sup> spacetime dimension to generate the 12<sup>th</sup> spacetime dimension as a superbrane volumar spacetime, so creating the shadow universe through the mathematical topology and definition of the Klein Bottle manifold of being one-sided but self-intersecting itself in the 11-dimensional Witten surface.

This Witten Mother-Magic-Membrane-Mirror as the 11<sup>th</sup> dimension and connector of the two universes will encompass the hyper-spacetime of Kaluza-Klein as four space dimensions with one time dimension, embedding five dimensions within eleven dimensions and displacing the six twistor dimensions as three rotation dimensions in rotation space and with three vibration- or frequency dimensions in quantum space.

The boundary of the hyper-spacetime will be a 3-dimensional surface or volumnar, embedded within a 4-dimensional volumnar, defined in the geometry and topology of hyperspace as  $V_4 = \frac{1}{2}\pi^2 R^4$  and  $dV_4/dR = (2\pi R)(\pi R^2) = 2\pi^2 R^3$  and so the volume of a Horn torus in 3 dimensions, also known as a Riemann sphere with radius  $R_{\text{torus}}$ .

In geometric terms, this indicates that a 3-dimensional sphere as the size and volume of the universe with radius  $R_3$  is equal in volume to a Horn torus with radius.

$R_{\text{torus}} = \sqrt[3]{\{2/3\pi\}R_3}$  and so the radius of the Horn torus is reduced by a factor of 1.6765... from the radius  $R_3$  of the sphere in three dimensions.

Doubling the radius of the Horn torus as the radius for the encompassing sphere as  $R_3 = 2R_{\text{torus}}$  so shows that 8 spheres of radius  $R_{\text{torus}}$  fit precisely into an encompassing sphere with radius  $2R_{\text{torus}}$ .

But considering the volume of the universe as a 3-dimensional boundary with  $V_3 = dV_4/dR = 2\pi^2 R^3$  to embed a 3-dimensional volume  $V_2 = (4\pi/3)R_2^3$  with its boundary as surface area  $dV_2/dR = 4\pi R_2^2$  then defines a boundary condition of  $R_4 \geq \sqrt[3]{\{2/3\pi\}R_2}$ , showing that in an expanding and time evolving universe; the 3-dimensional torus volumnar will attain its critical nexus of changing from its 3-dimensional volumnar status into a 3-dimensional surface membrane status at a time given by the boundary condition.

This time marker has been calculated as occurring 994.78 million years ago; correlating with a time upon planet Earth, when the first multicellular lifeforms emerged from their unicellular ancestors. Then the topological geometry of the universe changed from a single positive de Sitter curvature into a combination of its positive spheroidal de Sitter curvature with a negative hyperbolic Anti de Sitter curvature in 4-dimensional spacetime, cancelling the positive curvature to manifest a perfectly flat universe with zero curvature.

This can be visualized at the center of the Horn torus, where the tangential curvature of the torus radii meets in the horizontal plane to create the concave topology of a wormhole or an Einstein-Rosen bridge with the surface of the torus radii curving away from the center and for the emergence of geometric circular cross sections as the northern top and the southern bottom of the Horn torus.

But at the north pole and south poles of the vertical plane connecting the two hemispheres of the prior encompassing 3-dimensional spherical volumnar, the curvature is convex, cancelling the concave curvature intrinsic for the cosmological evolution of the universe to all of the time prior to the critical curvature time marker and as measured and observed by any observer within the expanding universe.

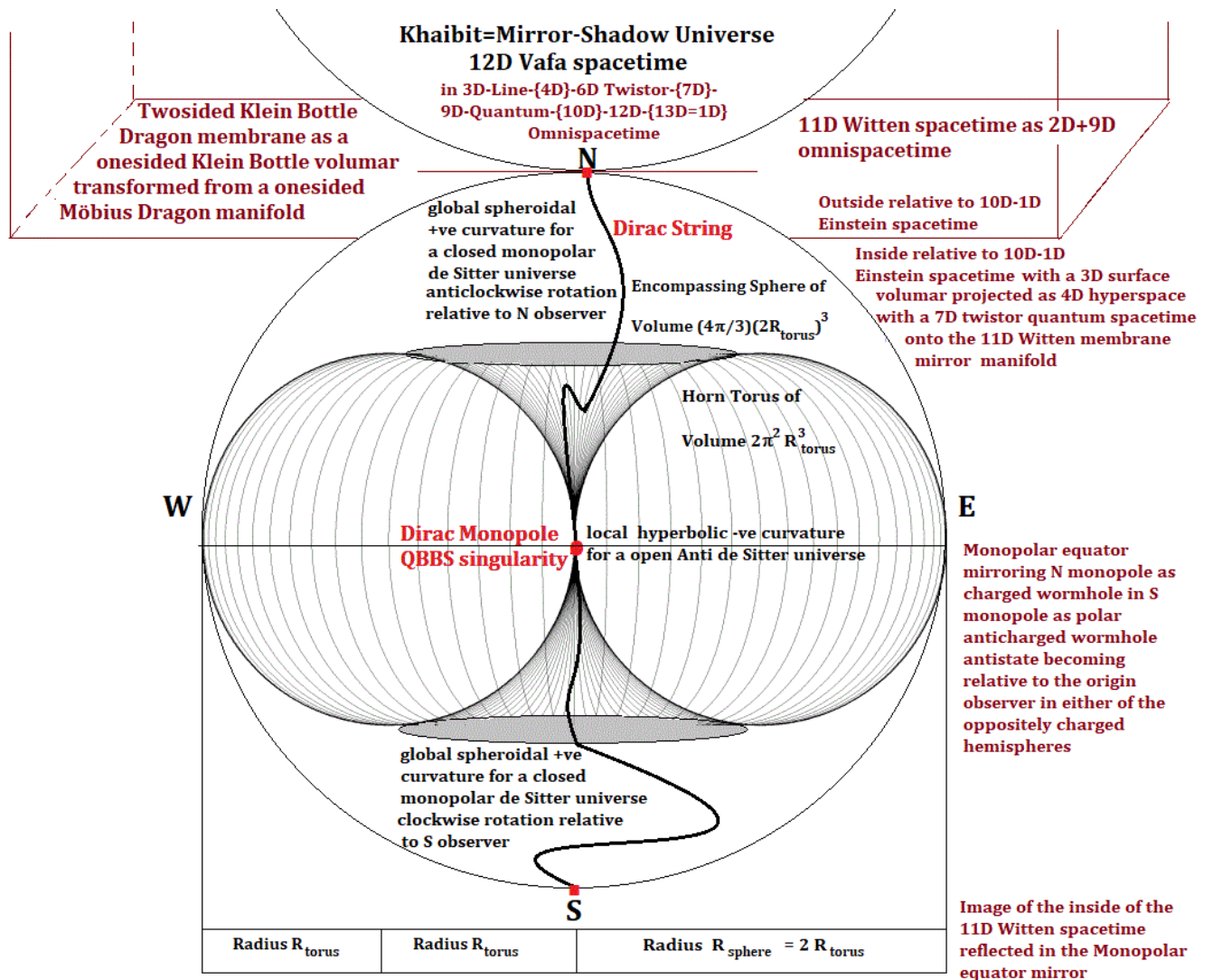

This prior realm or world is described as the outside boundary of the manifested singularity of the QBBS, with the inside boundary defining the physical universe as the fifth of five abstract mathematical singularities and as a one-dimensional entity in transforming its nature as a mathematical point into that of a mathematical line known as a Dirac string.

A Dirac string so allows the mathematical abstraction of the point space to transform into a point line requiring space to extend into as itself and as a Y direction in some coordinate system.

The minimum parameter spacetime so enables a second dimension to emerge from the Dirac string, as the 1<sup>st</sup> dimension of a minimized line segment of wavelength  $\lambda_{\text{weyl}}$  curls itself around the mathematical point space it used to occupy as a segment of the Dirac string.

This process changes the first dimension of the Dirac string from a time dimension into a 1<sup>st</sup> space dimension as the now space limited summation of mathematical line segments and redefines the newly created space dimension of the XY-plane as a quasi-time dimension.

The entire Dirac string so transforms itself as a mathematical point without extent into a mathematical line of any number of such point spaces to create the Dirac string extending in two polar directions from the mathematical singularity of the QBBS.

As there is no limit of how many mathematical points can exist in the Information-Energy prior spacetime plenum, the Dirac string is initially infinite as a consequence of no spacetime existing at the point of creation known as the first instant of time or the Instanton.

As the individual point spaces integrate as a sum of such point spaces however, each individual point preserved its individual universal identity in circularizing its point space into a membrane- or string space in the XY-plane.

The Weyl wavelength  $\lambda_{\text{weyl}}$  so became redefined from its circular form as the perimeter of a point circle as the displacement of the circumference from the center of the point circle as its wormhole radius.

With the creation of a 2<sup>nd</sup> area or surface dimension from the point circle count from the mathematical point count, two orthogonal directions emerged from the potential infinite Dirac string, which became upper and lower bounded in changing the expansion from the lower bounded origin to the universal north as self-relative positive upper bound in a direction from the origin towards the self-relative positive east with a simultaneous creation of the self-relative negative west direction in the transformation of the expansion towards the self-relative south as the mirror of the positive and negative polarities of the upper bound in the origin.

This creation of the second dimension so formed a limit for the mathematical point spaces extending in space and in time into two opposite directions.

The potential infinite line space became halted in the QBBS defining the two endpoints as two Weylian wormholes defined in the Guth-de Broglie Inflaton and mirrored at the origin as two polar opposites but identical minimum timespace configurations.

The northern positively charged wormhole so observes the self-relative anticlockwise rotation as effect of the righthanded torque of the Dirac string projecting orthogonally from the newly created XY-plane into the XZ-plane of a so created third dimension and with the torque angular displacement defining a new positively charged part of the northern hemisphere as pointing into the positive Z-axis direction or 'out' from the XY-plane.

The southern negatively charged wormhole in the southern hemisphere corollary projects the torque in the negatively charged XY-plane in a clockwise rotation 'into' the XY-plane of the third dimension to complete the 8 sectors of the geometrically defined encompassing 3-dimensional sphere with radius twice the torus radius.

The four torus radii so define the radius of the sphere in meeting at the QBBS singularity physically defined as the Dirac magnetic monopole. The second quasi-time dimension so becomes a real space dimension, and the newly created 3<sup>rd</sup> dimension takes its place as a quasi-time dimension acting on the XY-plane as a flatland of membrane spacetime.

## The Dirac Magnetic Monopole and the Instanton-Inflaton Quantum Entanglement of Wormholes

The Dirac monopole is defined only at the singularity as the QBBS but is connected via the Dirac string in an arbitrary gauge space, defining potential energy in any place of the universe defined in a three-dimensional parameter space, subject to the initial boundary conditions derived from the timespace of the higher dimensional plenum of nowhere in notime.

It so is the Dirac string, which allows the point potentials to transform into string potentials in the rotation space around the Dirac string transforming individual point potentials into the Weylian wormhole potentials and integrating and summing subsequently about the three orthogonal space directions of the X-Y-Z plane intersection. The magnetic monopole singularity of the QBBS so is defined as the Weylian wormhole of creation and the initial boundary condition for this minimum spacetime configuration becomes a conformal mapping of the Planckian wormhole from the timespace of the information plenum of algorithmic and mathematical definitions.

The northern- and southern parts of the Dirac string were defined as infinite, before becoming bounded in the creation of the second dimension followed by the emergence of the 3<sup>rd</sup> dimension and the Weyl string in 2 space dimensions with a quasi-spacetime dimension, able to potentialize the timespace parameter definitions to create a 3-dimensional space with a 4<sup>th</sup> spacetime dimension.

The QBBS parameter spacetime definitions of the boundary conditions for the inflaton now fully integrate a fourth real time dimension and manifest the Weylian wormhole volumar as a Black Hole defined by the instanton.

The nature of the inflaton so is to free the third quasi-spacetime dimension from its original definition of being potentially infinite in extent but existing in a space less gauge free parameter realm of pure real time without one-dimensional space defining the number count of the timespace in nowhere in notime, or as existing in a free parameter world of infinite one-dimensional space without time.

### Dirac's Quantization Condition for magnetic charge $g$ as proportional to electric charge $e$

The monopole of mass  $m_m$  and magnetic charge  $q_m$  circulates at a radius  $r$  and velocity  $v$  in the electric field between two capacitor plates in the XY-plane within a constant electric field  $\mathbf{E}=\mathbf{Ez}$  and where  $\mathbf{z}$  is the unit vector in the Z direction connecting the two poles.

The Lorentz force  $q_m v B = q_m v E / c$  balanced by the centripetal force  $m_m v^2 / r$  then gives, in the classical high energy limit for  $v \sim c$

$$E = m_m v c / r q_m \dots\dots\dots [\text{Eq. II-1}]$$

The energy of the monopole is quantized in the Landau quantization  $E_n = \hbar f (n + \frac{1}{2}) = (\hbar \omega / 2\pi) (n + \frac{1}{2})$  and as a result of using the Hermitian function  $\Psi_n(x)$  as general form for a probability frequency distribution and used to derive the form for a classical 1-dimensional harmonic oscillator in the form of a quantum harmonic oscillator in quantum mechanics.

The Normal distribution formula has a form  $\Psi(x) = \{1/\sqrt{2\pi}\}e^{-1/2x^2}$  which is found in the Hermitian function:

$$\psi_n(x) = \frac{1}{\sqrt{2^n n!}} \cdot \left(\frac{m\omega}{\pi\hbar}\right)^{1/4} \cdot e^{-\frac{m\omega x^2}{2\hbar}} \cdot H_n\left(\sqrt{\frac{m\omega}{\hbar}}x\right), \quad n = 0, 1, 2, \dots$$

The functions  $H_n$  are the physicists' Hermite polynomials.

$$H_n(z) = (-1)^n e^{z^2} \frac{d^n}{dz^n} (e^{-z^2}).$$

The corresponding energy levels are

$$E_n = \hbar\omega \left(n + \frac{1}{2}\right) = (2n + 1) \frac{\hbar}{2} \omega.$$

The classical form for the harmonic oscillator is given by the Hamiltonian:

$$\mathcal{H} = p^2/2m + \frac{1}{2} kx^2 = p^2/2m + \frac{1}{2} m\omega^2 x^2$$

The kinetic energy  $p^2/2m = m^2 v^2/2m = \frac{1}{2} m v^2$  and potential energy  $\frac{1}{2} kx^2 = \frac{1}{2} m\omega^2 x^2$  from Hooke's law and the equation of motion:

$F = -kx = m d^2x/dt^2$  and a solution  $x(t) = A \cos(\omega t + \text{constant})$  with  $dx/dt = -\omega A \sin(\omega t + \text{constant})$  and with  $d^2x/dt^2 = -\omega^2 A \cos(\omega t + \text{constant})$ , defining  $\omega = \sqrt{k/m} = 2\pi f = 2\pi/T$

The energy levels of the classical Hamiltonian then correspond to the eigenvalues of the Hermitian operator  $\mathcal{H}(\Psi) = (i\hbar/2\pi) d\Psi/dx$  for the momentum operator  $p = -(i\hbar/2\pi) \partial/\partial x$

The time independent Schrödinger equation  $\mathcal{H}(\Psi) = E(\Psi)$  then allows solution for the wave function  $x |(\Psi) = \Psi(x)$  for the eigenvalues of the Hermite function  $H_n(x)$

as Landau poles and with energy levels  $E_n$  quantized in integer  $n$  and defining a minimum harmonic quantum oscillator for  $n=0$  as the Zero-Point Energy of the Planck oscillator

$$E_0 = \frac{1}{2} (i\hbar/2\pi) \omega_0 = \frac{1}{2} (i\hbar/2\pi) (2\pi f_0) = \frac{1}{2} \hbar f_0$$

The mass of the monopole can be equated with the mass of a particle accelerated in a cyclotron for the high energy limit.

For a cyclotron frequency  $\omega = 2\pi f_c$  from  $mv^2/r = qBv$  with  $v = r q B/m$  and  $\omega = v/r = qB/m = qE/mc$  and  $E = cB$  for the coupling of the electric field with the magnetic field for

$$\omega = q_m E / m_m c \dots \dots \dots [\text{Eq.II-2}]$$

The quantized kinetic energy for the orbit of the magnetic monopole so is  $\frac{1}{2} m_m v^2 = n \cdot \hbar f$  for  $\omega = 2\pi f = q_m E / m_m c$  for

$\frac{1}{2} m_m v^2 = n \cdot \hbar f = n \cdot \hbar \omega / 2\pi = n \cdot \hbar q_m E / 2\pi m_m c$  and describing the quantization of angular momentum  $J_z$  for the magnetic monopole about the Dirac string.

$$J_z = m_m v r = 2n \cdot (\hbar/2\pi) \dots \dots \dots [\text{Eq.II-3}]$$

$m_m v = 2n \cdot (h/2\pi)/r = Erq_m/c$  by [Eq.II-1] for a quantization condition for the electric field  
 $E = 2n \cdot (hc/2\pi)/r^2 q_m \dots \dots \dots$  [Eq.II-4]

And without the zero-point dark energy minimum Planck quantum harmonic oscillator, in the Landau poles  $E_n = hf(n+1/2)$ , which can be said to exist as a precursor of the manifestation of the Quantum Big Bang in a string-membrane epoch defined from an oscillation of the Planck displacement as the original quantum fluctuation

$$L_{\text{planck}} = e/c^2 v \alpha = v \{hG_o/2\pi c^3\} = \{G_o/c^2\} m_{\text{planck}}$$

This quantum displacement ‘bounce’ of the minimum spacetime configuration initiated the interdependency of fundamental constants, utilized in the laws of nature in defining the ratio of electrocharge over the squared speed of light  $c^2$  in unitizing two unitary measurement systems; one mass centered in the form of Planck units suppressing universal charge, both electric and magnetic and the other suppressing universal mass in the corollary of charge centered Stoney units.

The coupling of those two unitary systems then unifies the finestructures of energy-charge based electromagnetism with those of an energy-mass based gravitational interaction.

The angular momentum  $J_z$  relates to the electric field  $E$  in [Eq.II-1] for the mass of the monopole in  $Erq_m/vc = m_m = 2n \cdot (h/2\pi)/vr$  and the positive charge at the north pole and the negative charge on the south pole, considered to be infinite in extent but intersected by the cylindrical circular flux areas at the two poles for a total charge density of  $E \cdot dA = E \cdot 2\pi r^2 = 2Q/\epsilon_o = 2\sigma_e \pi r^2/\epsilon_o$  for  $E = 2\sigma_e/2\epsilon_o = \sigma_e/\epsilon_o = 2Q/2\epsilon_o \pi r^2 = Q/\epsilon_o \pi r^2$  for  $\Sigma Q = \sigma_e \pi r^2$  for each capacitor plate

$$E = 2n \cdot (hc/2\pi)/r^2 q_m = \sigma_e/\epsilon_o = Q/\pi r^2 \epsilon_o \dots \text{and charge quantization } Q = 2\pi \epsilon_o \{n \cdot hc/2\pi\}/q_m \dots \text{for } Q = \Sigma e = N \cdot e \dots \dots \dots$$
 [Eq.II-5]

Dirac’s quantization condition follows as  $q_m Q = 2\pi \epsilon_o \{n \cdot hc/2\pi\} = \{(4\pi \epsilon_o hc)/2\pi e^2\} \{1/2 n \cdot e^2\} = \{n \cdot e^2/2\alpha\}$  for  $q_m = n \cdot e^2/2\alpha N \cdot e = n \cdot e/2N\alpha$  for the Magnetic monopole  $q_m = n \cdot e/2N\alpha = \{n/N\} \{e/2\alpha\} \dots \dots \dots$  [Eq.II-6]

Dirac’s quantization condition for the nature of a magnetic monopole being coupled in its magnetic charge to the electric charge of an electron, so relates Dirac’s constant of [Eq.II-8] in defining.

$q_m = (\text{Dirac’s Constant})(\text{an expression as a multiple of } e/2\alpha)$  and so presenting [Eq.7a] in a form of:

$$e^* = n \cdot e/4\alpha = \{n/2\} \{e/2\alpha\} = \tilde{D}_{\text{dirac}} \{e/2\alpha\} \dots \dots \dots$$
 [Eq.II-7]

and where  $\tilde{D}_{\text{dirac}}$  becomes Dirac’s Constant with the modular duality between the quantization of the classical electron radius  $R_e$  in the Weyl radius  $r_{ps}$  in trigonometric and radian  $\pi$  ( $\pi$ ) in the integer proportionality ratio  $\{360R_e/2\pi r_{ps}\} = \{360R_e/\lambda_{ps}\} = 10^{10}$

$$\tilde{D}_{\text{dirac}} = 8\pi c R_e e/G_o h = 4R_e [ec]/L_{\text{planck}}^2 c^3 = \{n/2\} \leftrightarrow \{n\pi/360\} = 4.54214 \times 10^{19} [C/m^3 s^{-2}]^* \dots$$
 [Eq.II-8]

$$\text{for } n = 8\pi c R_e e/G_o h = 8\pi c \{10^{10} \lambda_{ps}\} e/180 G_o h \leftrightarrow 8\pi c \{10^{10} \lambda_{ps}\} e/\pi G_o h = (240c^2)(15 \times 10^{20}) e = 36 \times 10^{22} e c^2$$

$$n = 324 \times 10^{38} e \text{ for } n(2\pi/360) = (3.24 \times 10^{40})(2\pi e/360) = 2 \tilde{D}_{\text{dirac}}$$

from the algorithmic integer definition for fundamental constants  $c^2$ ,  $h$  and  $|k=1/G_o=1/4\pi \epsilon_o=30c|_{\text{mod}}$

The derivation of Dirac's constant indicates the symmetry in Maxwell's equations in a form of rendering the point charge magnetic monopole of Paul Dirac as equivalent to the 't Hooft-Polyakov magnetic monopole of a Grand Unification energy spectrum, bounded in a finestructure unification condition relating the gravitational interaction to the electromagnetic interaction and so allowing the point charge electron of QFT and QED to reclaim its classical definition in the parameters of the electromagnetic fine structure alpha  $\alpha=2\pi k_e e^2/hc=e^2/2\epsilon_0 hc=\mu_0 c e^2/2h=60\pi e^2/h$  via the electron's total energy given by

$m_e c^2 = k_e e^2 / R_e$  for the classical electron radius as a function of its mass  $m_e$  for  
 $R_e = k_e e^2 / m_e c^2 = 2\pi k_e h e^2 / 2\pi h c^2 m_e = h\alpha / 2\pi c m_e = \alpha \{h / 2\pi c m_e\}$   
 $= \alpha R_{\text{Compton}} = \alpha^2 \{h^2 / 4\pi^2 k_e m_e e^2\} = \alpha^2 R_{\text{Bohr}1} = \alpha^2 \{Z R_n / n^2\} = \alpha^2 \{Z / R_{\text{Rydberg}} n^2\}$  and where  $R_{\text{Rydberg}}$  defines the quantized electron energy levels in the wavelength.

$1/\lambda_e = R_{\text{Rydberg}} \{1/n^2 - 1/(n+1)^2\}$  in the Bohr atom for quantized angular momentum  $nh/2\pi = m_e v R$  for  $v = nh/2\pi m_e R$  or total energy  $KE + PE = \{-\frac{1}{2}PE + PE\} = \frac{1}{2}m_e v^2 - Zk_e e^2/R = -Zk_e e^2/2R$  for  $E_n = hf_n = hc/\lambda_n$

The lower bounded unification monopole describing the Dirac magnetic monopole has a Maxwellian displacement current along the Dirac string in units of [Am] but manifesting as a mass equivalence  $m_{\text{monopole}} = [ec]_{\text{mod}} = 4.818 \times 10^{-11} \text{ kg}^*$  for an energy  $[ec]_{\text{mod}} c^2 = ec^3 = 2.7 \times 10^{16} \text{ GeV}^*$





## Richard Feynman's derivation for Dirac's Quantization Condition for magnetic charge $g$ as proportional to electric charge $e$

Richard Feynman's method to derive Dirac's quantization condition shows how to embed the Dirac string into two path integrals in a quantum-mechanical derivation, using two wave functions  $\Psi(x_1, t_1); \Psi(x_2, t_2)$ , connecting two points A and B in two path integral summations  $e^{[2\pi i/\hbar]S(x_1)}$ ,  $e^{[2\pi i/\hbar]S(x_2)}$  for probability amplitudes  $P=|K|^2$  and  $K= \Psi_1 \cdot \Psi_2 = \int D(x) e^{[2\pi i/\hbar]S(x)}$  and for classical action  $S(x)=\int \mathcal{L}(x, dx/dt) dt$  and Lagrangian  $\mathcal{L}$  and where the summation of all paths is symbolized by  $D(x)$

Then  $K=K_1+K_2= \int D(x) e^{[2\pi i/\hbar]S(x_1)} + \int D(x) e^{[2\pi i/\hbar]S(x_2)}$  for the action of a free particle unaffected by the Dirac string field enclosed by the two path integrals summed over all possible paths,  $S(0)= \int KE dt = \int (\frac{1}{2} m dx/dt) dt$   
 $P=|K_1+K_2|^2$

Action  $S(1)$  however interferes with action  $S(2)$  in the external vector potential  $\mathbf{A}_L$  in units of charge density  $(q/\epsilon_0 = \mu_0 g)$  in the action  $S=S(0)+(q/c) \int \mathbf{A}_L \cdot d\mathbf{L}$ . The closed path integral so becomes  $\oint_C \mathbf{A}_L \cdot d\mathbf{l} = \int \mathbf{A}_2 \cdot d\mathbf{l} - \int \mathbf{A}_1 \cdot d\mathbf{l}$  for path A to B to A changing direction from clockwise to anticlockwise or vice versa.

$$K = \int_1 D(x) e^{[2\pi i/\hbar](S(0)+[q/c] \int_1 \mathbf{A} \cdot d\mathbf{l})} + \int_2 D(x) e^{[2\pi i/\hbar](S(0)+[q/c] \int_2 \mathbf{A} \cdot d\mathbf{l})} = \{K_1 + e^{[2\pi i q/hc] \oint_C \mathbf{A}_L \cdot d\mathbf{l}} K_2\} e^{[2\pi i q/hc] \int_1 \mathbf{A} \cdot d\mathbf{l}}$$

The interference term of the closed path

$$e^{[2\pi i q/hc] \oint_C \mathbf{A}_L \cdot d\mathbf{l}} \text{ for } \oint_C \mathbf{A}_L \cdot d\mathbf{l} = \iint \nabla \times \mathbf{A}_L \cdot d\mathbf{A} = \iint \mathbf{B}_{\text{monopole}} \cdot d\mathbf{A} + \iint \mathbf{B}_{\text{string}} \cdot d\mathbf{A}$$

Then  $e^{[2\pi i q/hc] \oint_C \mathbf{A}_L \cdot d\mathbf{l}} = e^{[2\pi i q/hc] \iint \mathbf{B}_{\text{monopole}} \cdot d\mathbf{A}} e^{[2\pi i q/hc] \iint \mathbf{B}_{\text{string}} \cdot d\mathbf{A}}$  for  $e^{[2\pi i q/hc] \iint \mathbf{B}_{\text{string}} \cdot d\mathbf{A}} = 1$ , as the Dirac string of dimension 1 is not observable, the vector potential being undefined everywhere except at the singularity. The magnetic flux is however  $\iint \mathbf{B}_{\text{string}} \cdot d\mathbf{A} = \mu_0 q_m = g/\epsilon_0$  for  $e^{2\pi i (qg/hc\epsilon_0)} = 1$  for  $4\pi qg e^2 / 4\pi \epsilon_0 h c e^2 = 2 \cdot qg \alpha / e^2 = 2\alpha g/e$  and  $g = n \cdot e / 2\alpha$  for  $q=e$  and  $e^{2\pi i \cdot n} = 1$

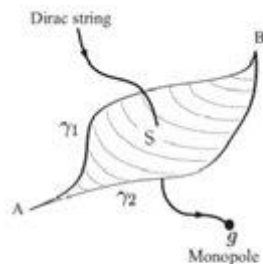

Figure 8. A Dirac string is enclosed between two generic paths  $\gamma_1$  and  $\gamma_2$  starting at A, ending at B, and forming the boundary of the surface S.

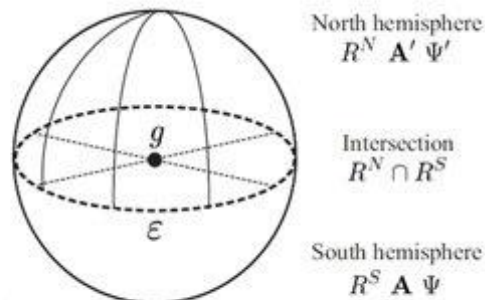

Figure 9. The Wu-Yang configuration describing a magnetic monopole without the Dirac strings.

Feynman's path integrals encompass the Dirac string not at the center of the volume harboring the magnetic monopole singularity.

Placing the singularity at the center and allowing the two parts of the Feynman derivation of the Dirac quantization condition to be the two hemispheres of a sphere with the magnetic monopole at the center of the sphere as done by the Wu-Yang configuration allows a cylindrical representation of the topology applicable to the entire universe.

[1810.13403.pdf \(arxiv.org\)](https://arxiv.org/pdf/1810.13403.pdf)

As the Dirac string is one-dimensional without any width, the surface area for the magnetic flux of  $2(2\pi R^2)$  the magnetic monopole for cylinder radius  $\sqrt{2}R$  for surface area  $4\pi R^2$  describes the Dirac monopole as the central singularity and magnetic point charge for the cosmology.

The surface area for the universe is represented by the magnetic flux of the monopole as a one-dimensional form of energy manifesting the Quantum Big Bang from the monopolar singularity, albeit in using a higher dimensional string-membrane epoch characterized by the definition of a minimum spacetime configuration as a quantum fluctuation of the Planck length by the zero point quantum harmonic oscillator, defined as the Weyl-Eps quantum of creation as the inverse of the magneto charge  $e^*$  in units of the gravitational parameter GM, defining a new charge unit of the star coulomb as the physicalisation of consciousness as a quantum angular acceleration acting on any spacetime volumar.

Quantum Field Theory (QFT) and Quantum Electrodynamics (QED) become enabled to replace the point charge electron with the point charge of the Dirac-'t Hooft-Polyakov magnetic monopole, so allowing the classical electron radius  $R_e$  to enter the physical descriptions in the quantum field theories.

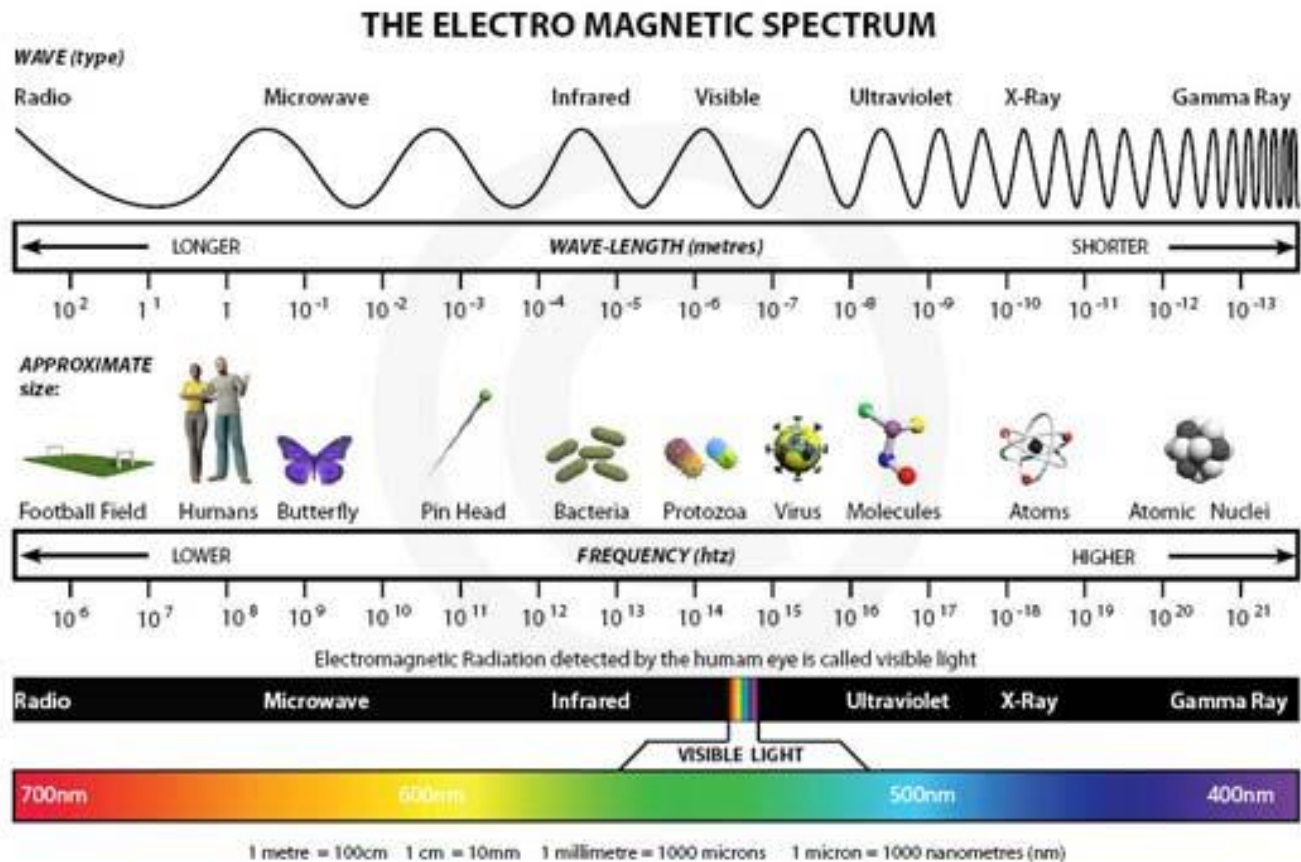

© Colour Therapy Healing 2010 - [www.colourtherapyhealing.com](http://www.colourtherapyhealing.com)

The monopolar singularity observer is displaced from the equatorial plane at the center of the earth as the center of the spacetime relative universe

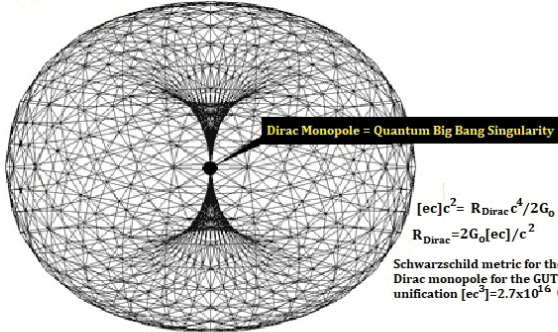

Earth Rotation = Counter clockwise or left handed above the equator  
 Earth Rotation = Clock-wise or right handed below the equator

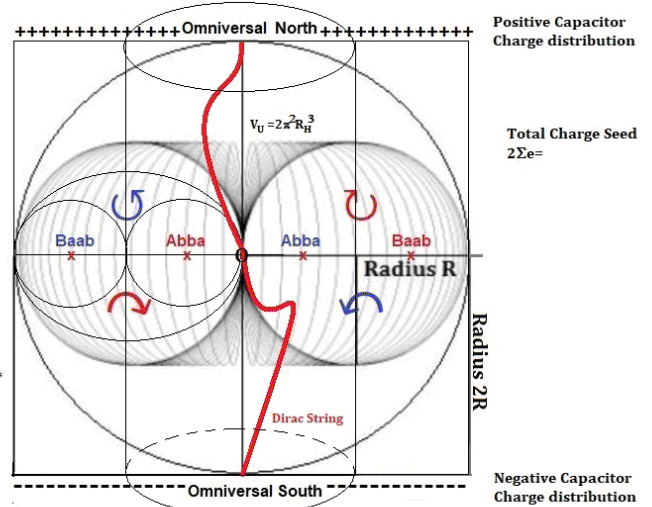

Volume of encompassing sphere radius 2R:  $V_{Sphere} = 4\pi(2R)^3/3 = 32\pi R^3/3 = 8(4\pi R^3/3)$

Volume of embedded horn torus radius R:  $V_{Torus} = (\pi R^2)(2\pi R) = 2\pi^2 R^3$

$\frac{V_{Sphere}}{V_{Torus}} = 16/3\pi = 1.6976527... = 8(2/3\pi) = 8.lim\{\delta_F\}$  Upper limit for the Feigenbaum Chaos-Complexity Constant  $\delta_F$

About 1.7 horn torus volumars fit into the circumscribing and encompassing spherical volumar, the latter describing 8 spheres of radius R, each sphere inscribed in a cube side R.  
 4 cubes and 4 spheres radius and side R then define the multidimensional space as hyperspace above and below the universal equatorial plane.  
 The north polar positively charged capacitor plate so becomes the top and the south polar negatively charged capacitor plate the bottom of a hypercube, bounded by 2 infinite planes, albeit intersected in a cylinder crossed by the Dirac string.

As the Dirac string is one-dimensional without any width, the surface area for the magnetic flux of  $2(2\pi R^2)$  the magnetic monopole for cylinder radius  $\sqrt{2}R$  for surface area  $4\pi R^2$  describes the Dirac monopole as the central singularity and magnetic point charge for the cosmology.

The surface area for the universe is represented by the magnetic flux of the monopole as a one-dimensional form of energy manifesting the Quantum Big Bang from the monopolar singularity, albeit in using a higher dimensional string-membrane epoch characterised by the definition of a minimum spacetime configuration as a quantum fluctuation of the Planck length by the zero point quantum harmonic oscillator, defined as the Weyl-Eps quantum of creation as the inverse of the magneto charge  $e^*$  in units of the gravitational parameter GM, defining a new charge unit of the starcoulomb as the physicalization of consciousness as a quantum angular acceleration.

Quantum Field Theory (QFT) and Quantum Electrodynamics (QED) become enabled to replace the point charge electron with the point charge of the Dirac-'t Hooft-Polyakov magnetic monopole, so allowing the classical electron radius  $R_e$  to enter the physical descriptions in the quantum field theories.

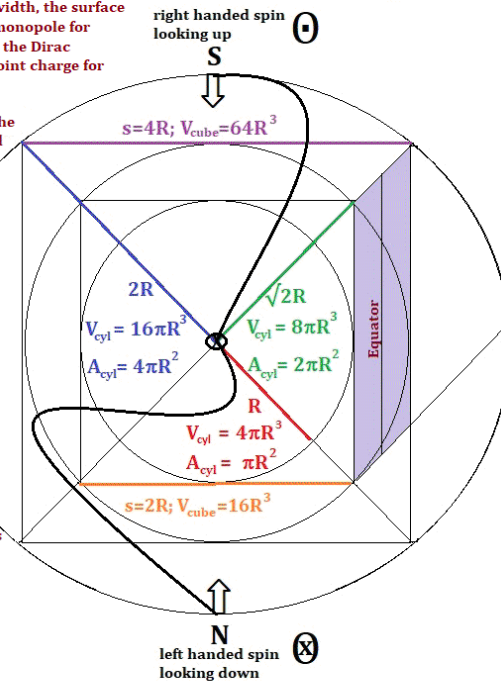

## Dirac's string modeled as spanning the universe for a singular magnetic monopole at the center of the earth

Dirac's monopole can then be defined as a singularity monopole of magnetopole charge  $e^* = Q_m$ , connecting the two opposite sides of the universe in the Hubble horizon  $R_H = c/H_0$  in the Dirac string. The spacetime observer relative universal north pole so is given as the positive charge distribution placed onto the northern hemisphere of the universe in a 3-dimensional surface derivative  $dV_4/dR = (2\pi R_H)(\pi R_H^2) = 2\pi^2 R_H^3$  from the 4-dimensional hypersphere  $V_4(R) = \frac{1}{2}\pi^2 R^4$ .

The southern hemisphere then becomes the negative charge distribution as a 3-dimensional volume connecting the Dirac string from its south pole to the north pole. The two infinite capacitor plate surfaces so are given in the higher dimensional string-membrane space which so effectively 'cube' the volume of the 3-dimensional sphere embedded in a 4-dimensional hyperspace as a 3-dimensional surface or membrane space.

The Dirac string starts from, and terminates on, a magnetic monopole. Thus, assuming the absence of an infinite-range scattering effect by this arbitrary choice of singularity, the requirement of single-valued wave functions (as above) necessitates charge-quantization.

That is,  $4\pi \cdot 2q_e q_m / 4\pi \epsilon_0 h c = 8q_e q_m \{\alpha\} / \{2e^2\} = 4\alpha e^* / e$  must be an integer  $n$  for any (dipolar) electric charge  $q_e$  and magnetic charge  $q_m$ .

$e^* = n \cdot e / 4\alpha = \{n/2\} \{e/2\alpha\} = \delta_{\text{dirac}} \{e/2\alpha\}$  and where  $\delta_{\text{dirac}}$  becomes Dirac's Constant

**The Dirac Constant for the Universal Cosmology and with  $n = 324 \times 10^{38}$   $e = 5.204918555 \times 10^{21}$**   
 $\delta_{\text{dirac}} = 8\pi c R_e e / G_0 h = 4R_e [ec] / L_{\text{planck}}^2 c^3 = n\pi e / 360 = 4.54214 \times 10^{19} [C/m^3 s^{-2}]^* \dots \dots \dots [Eq. II-8]$

in units of the star coulomb defining the magneto charge  $e^*$  in a universal unit calibration  $[C^*] = [C^2/C^*] = [C^2 s^2 / m^3]$  and where the mensuration units for the gravitational parameter  $[GM] = [Nm^2 kg / kg^2] = [m^3 / s^2] = [C^*]$  as the units for universally defined physicalized consciousness as an angular quantum acceleration  $(df/dt)$  acting on any spacetime volume of units  $[m^3]$  as the effect of the Dirac string manifesting at the observer relative center of the universe and as given in the location of the Dirac magnetic monopole at this center as a definition of the Quantum Big Bang Singularity (QBBS).

The derivations consider the magnetic permeability constant of 'free space'  $\mu_0 = 4\pi \times 10^{-6} \text{ H/m}$  as a universal constant related to the impedance of 'free space'  
 $Z_0^2 = |E/H|^2 = |\mu_0 E/B|^2 = |\mu_0 c B/B|^2 = \mu_0 / \epsilon_0 = \{120\pi / c\} / \{1/120\pi c\} = \{120\pi\}^2$  and so describe a finestructure for Maxwell's constant  $\epsilon_0 \mu_0 = 1/c^2 [m/s]^2$  for the units of universal resistance in a calibrated mensuration system requiring the speed of light 'c' in units of  $[m/s]_S$  to transform into units of  $[m/s]^*$ . The units for the impedance  $Z_0$  so become measured in  $\sqrt{([H/m] / [F/m])^*} = \sqrt{([Js^2/C^2 m] [Jm/C^2])^*} = [V/I]^* = [Js/C^2]^* = [\Omega]^*$  and are observed in the physics of superconductivity in the form of the Quantum Hall effect  $n \cdot h/e^2$ , the conductance quantum  $2e^2/h$  and Josephson frequencies  $f = n \cdot E/h$ .

The 'free impedance' however relates to a deeper nature found in superconductive phenomena in that a dimensionless or modular resistance implies a natural law in the form of Action = Charge Squared as  $\{h = ee = ee^* = e^* e^*\}$ .

The Action Law is therefore descriptive for the relationship between electric charges of electropoles and magnetic charges of magnetopoles.

<p style="text-align: center;"><i>And God said</i></p> $\nabla \cdot \vec{E} = \frac{\rho_e}{\epsilon_0}$ $\nabla \cdot \vec{B} = \mu_0 \rho_m$ $\nabla \times \vec{E} = -\frac{\partial \vec{B}}{\partial t} - \mu_0 \vec{J}_m$ $\nabla \times \vec{B} = \mu_0 \vec{J} + \frac{1}{c^2} \frac{\partial \vec{E}}{\partial t}$ <p style="text-align: center;"><i>and there was light.</i></p>	<p style="text-align: center;"><i>Then Maxwell said</i></p> <p>For Divergence: <math>\iiint \nabla \cdot (\vec{E}, \vec{B}) dV = \text{Flux } \Phi_{e,m} = \iint (\vec{E}, \vec{B}) \cdot d\vec{A}</math>  For Curl: <math>\iint \nabla \times (\vec{E}, \vec{B}) \cdot d\vec{A} = \text{Flux } \Phi_{e,m} = \oint (\vec{E}, \vec{B}) \cdot d\vec{L}</math></p> $\iint \vec{E} \cdot d\vec{A} = \frac{Q}{\epsilon_0} = \int_V \frac{\rho_e}{\epsilon_0} dV$ $\iint \vec{B} \cdot d\vec{A} = 0 = \int_V \mu_0 \rho_m dV$ $\oint \vec{B} \cdot d\vec{l} = \mu_0 i_C + \mu_0 \epsilon_0 \frac{d\Phi_E}{dt} \quad \text{displacement}$ $\oint \vec{E} \cdot d\vec{l} = -\frac{d\Phi_B}{dt}$ <p style="text-align: center;"><i>Lorentz Force: <math>\vec{F} = q_e \{ \vec{E} + \vec{v} \times \vec{B} \} + q_m \{ \vec{B} - \vec{v} \times \vec{E} / c^2 \}</math></i></p>
---	---

Electric flux  $\phi_e = \Sigma q_e / \epsilon_0 = r_e V / \epsilon_0 = Q_e / \epsilon_0$   
Magnetic flux  $\phi_m = \Sigma q_m (\mu_0 c) = r_m V (\mu_0 c) = (\mu_0 c) Q_m$

Electric flux  $\phi_e = \nabla \cdot \vec{E} = [J/Cm^2] = \{\Sigma q_e\} [Jm/C^2m^3] = \{\rho_e\} [C^2/Jm] = \rho_e / \epsilon_0$  for the electric charge density per unit volume

Magnetic flux  $\phi_m = \nabla \cdot \vec{B} = \{1/c\} \nabla \cdot \vec{E} = [Js/Cm^3] = \{\Sigma q_m\} [Js/C^2m] = \mu_0 \rho_m$  for the magnetic charge density per unit area

The magnetic charge density for the Dirac monopole is  $\rho_m = e^* f$  as a source energy monopolar current  $i_{\text{monopolar}}$  per unit area as the Maxwell displacement current per unit area

$$\mu_0 e^* f / A_{ps} = (df/dt) / e^* e c^3 \text{ and } f^* = c / \lambda^* = A_{ps} (dt/df) / \mu_0 e^* e^2 c^3$$

The magnetic flux for the Dirac monopole is:

$$\phi_m = \mu_0 \rho_m = m_{ps} / [ec]_{\text{mod}} = m_{ps} c^2 / [ec]_{\text{mod}} c^2 = E_{ps} / [ec^3]_{\text{mod}} = [J/Am^3] / \{df/dt\} = [J/Am^3] / \{df_{ps}/dt_{ps}\} = [J/Am^3]$$

by modular string-membrane mirror duality  $E_{ps} = hf_{ps} = h/f_{ss}$  and  $E_{ps}/E_{ss} = f_{ps}^2 = 1/f_{ss}^2$  with  $\lambda_{ps} \cdot f_{ps} = c = 1/\lambda_{ss} f_{ss}$

The Maxwell displacement current for the Dirac magnetic monopole as the QBBS singularity manifests as the 't Hooft-Polyakov 'hedgehog' magnetic monopole in GUT unification as the minimum monopolar mass of  $[ec]_{\text{mod}} = 4.819369011 \times 10^{-11} \text{ kg}^*$  and energy  $[ec]_{\text{mod}} c^2 = 4.33743211 \times 10^6 \text{ J}^*$  as precisely  $2.7 \times 10^{16} \text{ GeV}^*$ . The upper bound for the 't Hooft-Polyakov monopole is  $30 [ec]_{\text{mod}} = 1.301229633 \times 10^8 \text{ J}^*$  or  $8.1 \times 10^{17} \text{ GeV}^*$  with the two bounds related to the gravitational parameter GM partial to the measurements of Newton's gravitational constant G and the energy of the 't Hooft-Polyakov magnetic monopoles of 'Grand-Unification' or GUT energy regimes.

The magnetic flux of the Dirac monopole becomes a mass ratio per unit area expressed as source energy per monopolar unification energy per unit area A with wormhole unit area.

$$A_{ps} = 6\pi^2 r_{ps}^2 = 3\lambda_{ps}^2 / 2 = 1.5 \times 10^{-44} \text{ [m}^2\text{]}^*$$

$$\phi_m = \mu_o \rho_m = \mu_o e^* f = m_{ps} / [\text{ec}]_{\text{mod}} = m_{ps} c^2 / [\text{ec}]_{\text{mod}} c^2 = E_{ps} / [\text{ec}^3]_{\text{mod}} = 1/e^* \text{ec}^3 = 4.611023179 \times 10^{-10}$$

$$\mu_o e^* f / A_{ps} = (df/dt) |_1 / e^* \text{ec}^3 \text{ and } f^* = c / \lambda^* = (df/dt) |_1 / \mu_o e^* \text{ec}^3 = 3\lambda_{ps}^2 (df/dt) |_1 / 2\mu_o e^* \text{ec}^3$$

$$= 3h^2 (df/dt) |_1 / 2\mu_o [\text{ec}] = 7.338671173 \times 10^{-7} \text{ Hz}^* \text{ per unit wormhole surface area, time}$$

$t^* = 1,362,644.512 \text{ s}^*$  and  $\lambda^* = c/f^* = 4.087933536 \times 10^{14} \text{ m}^*$  for radius  $R^* = \lambda^* / 2\pi = R(n^* = H_o t^*)$   
 $= 4.072259032 \times 10^{-13} = 6.506148293 \times 10^{13} \text{ m}^*$  for a time  
 $t^* = 216,871.61 \text{ s}^*$  or 2.5101 days into the expansion and thermodynamic evolution of the universe with a coordinate 928,452.09 seconds before the E-googol marker for the classical electron radius  $R_e$  modulation.

As the E-googol defines  $R_e(n) = 3.43597108 \times 10^{14} \text{ m}^*$  for a time  
 $t_E = n_E / H_o = 2.1506 \times 10^{-12} / H_o = 1,145,323.7 \text{ s}^*$  or 13.25606 days

$$R_e / R_E = r^* / R^* \text{ for } r^* = R^* R_e / R_E$$

$$= (6.506148293 \times 10^{13}) (2.777777 \times 10^{-15}) / (3.43597108 \times 10^{14}) = 5.25983302 \times 10^{-16} \text{ m}^*.$$

This displacement radius defines an effective electron mass via the Compton constant as  
 $m_e = \alpha h / 2\pi c r^* = 4.906433293 \times 10^{-30} \text{ kg}^*$  and reducing to a maximum mass at the QBBS instanton boundary as  
 $m_{\text{eff}} = m_{ps} = \alpha h / 2\pi c r_{ps} = 2.222 \times 10^{-20} \text{ kg}^*$

The Dirac constant calculates as:  
 $\tilde{\alpha}_{\text{dirac}} = 2\alpha e^* / e = 2\alpha / e E_{ps} = 4\alpha e m_{\text{planck}} \sqrt{\alpha} / e m_{\text{electron}}$   
 $= 4\alpha \sqrt{\{(hc / 2\pi G_o)(2\pi k_e e^2 / hc)\} / \{k_e e^2 / R_e c^2\}} = 4\alpha \sqrt{\{k_e e^2 / G_o\} \{2\pi R_e c^2 / hc \alpha\}}$   
 $= 8\pi R_e [\text{ec}] / G_o h \text{ [C/m}^3 \text{s}^{-2}\text{]}^*$   
for fine structure unification  $G_o = 4\pi \epsilon_o$  for  $\sqrt{\{k_e e^2 / G_o\}} = e / G_o$

The inflaton so draws the data from the information space to manifest the number count for the inflaton from the algorithmic definition of the Mathimatia, which is a label for the collected library in the timespace prior to the QBBS.

This number count would count the number of spacetime quanta the inflaton would encompass as a 3-dimensional surface bounding the 10-dimensional string space as the boundary of a Riemann sphere in de Sitter spacetime embedding the Anti de Sitter spacetime in the cancelling of the topological curvatures.

The number of space quanta for the inflaton to use is a googolplex of a number of googols, meaning number counts exceeding one hundred digital places.

The four googols and 8 data strings generated by particular algorithms and number sequences in the Mathimatia were:

$E=26 \times 65^{61}=1.006208782 \times 10^{112}$  as data string  $E^*=\{266561\}$  generating data string  $F^*=\{136656\}$  from programming code: {Add the End to the Beginning and Start the New Beginning with the Old Beginning}=Line A-Repeat

$F=13 \times 66^{56}=1.019538764 \times 10^{103}$  as data string  $F^*=\{136656\}$  and generating data string  $G^*=\{673665\}$  from programming code: {Add the End to the Beginning and Start the New Beginning with the Old Beginning}=Line A-Repeat

$G=67 \times 36^{65}=9.676924497 \times 10^{102}$  as data string  $G^*=\{673665\}$  and generating data string  $H^*=\{5[5+6=11]7366\} \neq H^*$  from the programming command: {If Sum is reductive}=Line B-End-Line C-Reverse Line A-Repeat

$H=Undefined$ , because  $5+6=11=2$  is root reductive in the number 11 the first initializing Maria Number in the Maria matrix for the numerical archetypes in time connector dimensions 1, 4 and 7 [Footnote1]  
 $D=46 \times 56^{12}=4.375363663 \times 10^{22}$  as data string  $D^*=\{465612\}$  from data string  $E^*=\{266561\}$  from programming code: {If Line A} Repeat

$C=25 \times 61^{24}=1.761392119 \times 10^{44}$  as data string  $C^*=\{256124\}$  from data string  $D^*=\{465612\}$  from programming code: {If Line A} Repeat

$B=36 \times 12^{42}=7.619295808 \times 10^{46}$  as data string  $B^*=\{361242\}$  from data string  $C^*=\{256124\}$  from programming code: {If Line A} Repeat

$A=31 \times 24^{23}=1.722742045 \times 10^{33}$  as data string  $A^*=\{312423\}$  from data string  $B^*=\{361242\}$  from programming code: {If Line A} Repeat

$Z=Undefined$ , because no process of  $3[3+U=1]2423$  can yield 312423 from data string U24233 with  $U=-2=-11$  for mirror root reduction in the Maria code and programming command:  
 {If Sum is reductive}=Line D-Define H

$H=ABCD=(31 \times 36 \times 25 \times 46) \times (24^{23} \times 12^{42} \times 61^{24} \times 56^{12})=(1,283,400) \times (7.882123905 \times 10^{141})$   
 $=1.011591782 \times 10^{147}$  from programming code: {if Line D}-End-Define H=ABCD-End-

The end of the googolplex algorithm, self-limited in the Maria matrix and the SEps algorithm limiting the universe defined from Khaibit and the timespace of a Planck-Stoney membrane timespace epoch immediately adjacent to the QBBS in the timespace-spacetime boundary of the Dirac string and the magnetic Dirac monopole so defines four spacetime markers E with F and G to be encompassed by the inflaton boundary H defined as a summation of wormhole quanta comprising the Riemann sphere as a 3-dimensional surface of volume  $dV_4/dR=(2\pi R)(\pi R^2)=2\pi^2 R^3$  and for a specific redefinition for the radius of the Riemann sphere as the Hubble event horizon  $R_H=c/H_0$ .

**[Footnote 1:]**

The Maria Code in the Riemann analysis specifies the partitioning of the decimal monad: {1;2;3;4;5;6;7;8;9;10} around the primary Maria number and SEps-Constant “11” for a prime number algorithm +1+11+10+11+ as 33-tiered segments, transforming the wave mechanics of the SEps number sequence into the 64-codex of a DNA/RNA genomatrix for its potential quadrupling as a 256-codex incorporative of dormant intron/intein coding.

The Maria Code is defined in the distribution of Maria numbers  $M_{p+99}=M_{p+12}$  for  $n=\frac{1}{2}\{V(264k+1) - 1\}$  by the quadratic  $n^2+n-66k=0$ .

Maria numbers are those integer counters, which contain all previously counted integers as mod|33|. The first Maria number so is  $1+2+3+4+5+6+7+8+9+10+11=66=2 \times 33$  for Maria#1=11 for k=2.

Archetypes  $2+3+5+6+8+9=33$  so define 6 of the 11 dimensions in the defined omni space for archetypes  $1+4+7=12$  completing the remaining 4-time connector dimensions in mirroring the limiting and boundary 12<sup>th</sup> dimension of Vafa omni space in the 10th omni space dimension across the 11-dimensional Witten-Mirror as the Maria-Mirror or Maria membrane connecting higher dimensional omni-spacetime to lower dimensional quantum-spacetime.

A repeating Maria matrix is symbolized in this table with symbols ♥=54=Love and ♠=45=Use

11♥	65♠	110♥	164♠	209♥	263♠	...Archetype 2
21♠	66♥	120♠	165♥	219♠	264♥	...Archetype 3
32♠	77♥	131♠	176♥	230♠	275♥	...Archetype 5
33♥	87♠	132♥	186♠	231♥	285♠	...Archetype 6
44♥	98♠	143♥	197♠	242♥	296♠	...Archetype 8
54♠	99♥	153♠	198♥	252♠	297♥	...Archetype 9
65♠	110♥	164♠	209♥	263♠	308♥	...Archetype 2*

**[End of Footnote 1:]**

The Hubble radius  $R_H$  is defined from first principles as the light path of the higher 11-dimensional monopolar light emitted in the QBBS as a monopolar electromagnetic radiation wave, travelling invariantly with lightspeed c in two parallel cosmologies.

The first cosmology in a lower dimensional universe is described by a Black Body Planckian Radiator modeled on a thermodynamic cosmological evolution in the hyperbolic negatively curved Anti de Sitter spacetime however enveloped by a de Sitter universe of positive curvature, thereby cancelling the curvatures to result in a flat Minkowski spacetime in 4-dimensional spacetime.

This Temperature dependent universe experiences its spacetime evolution in the energy interactions of the QBBS parameter space and engage a gravitational deceleration, which asymptotically will approach but never reach the asymptotic boundary as set by the inflaton.

This becomes a consequence of the higher dimensional universe; whose definitive parameter is the light path of the monopolar light and a light path not restricted by the matter content and the gravitational parameters in their lower dimensional form.



The QBBS parameter space allows a parallel evolutionary of the gravitational parameter GM in the unification of the electromagnetic and gravitational parameters applicable to the both of the parallel cosmologies through the definition of the 'QE UniPhysCon' as a physicalized universal consciousness defined in the nature of the Dirac monopole and its extension in the t' Hooft-Polyakov monopole of energy unification.

The 'Quantum Entangled' UniPhysCon then is defined by the gravitational parameter GM in the lower dimensional universe, but in the higher dimensional universe the definition of GM translates into the form of any spacetime volumar being acted upon by a radius independent quantum acceleration or a frequency differential over time subject to the modular duality defined in the timespace of the string-membrane-volumars in modular dualities of inversion and mirror properties of the parameters.

The motive and 'prime directive' for the QE UniPhysCon so is to transform gravitational potential energy in the form of the GM parameter and the matter content in the universe into physicalized universal consciousness quanta as the source energy quanta defined in the original Weylian wormhole as the effect of the nature of the Dirac monopole changing its status as a undefined source of magnetopolar charge into a defined source of electropolar charge, proportional to the nature of a magnetic charge, however able to manifest as magnetopolar charge as the inverse of the Weyl energy as the original source quantum of the QBBS.

An overarching reason and purpose for the existence of the universe as a multiverse within an omniverse from first principles is found in the nature of the universe as a holographic universe requiring a doubling of the physicalized universe from spacetime into timespace to satisfy the initial boundary conditions of the described omni spacetime of the 10-11-12 dimensional cosmology.

The 11-dimensional light path so defines the guiding evolutionary parameter for the thermodynamic expansion of the universe in the invariance of lightspeed c moving further away from the asymptotic gravitationally decelerating universe.

But there will be a time marker for the EMMR, as the Electro-Magnetic Monopolar Radiation meets the inflationary boundary at the intersection of the 10<sup>th</sup> string dimension with the 11<sup>th</sup> dimension of the Witten mirror in omni space.

This time marker has been calculated as the inverse of  $H_0=c/R_H$  and where  $H_0$  defines a nodal Hubble constant varying in time relative to a cycle time coordinate given in  $n=H_0t$  or  $dn/dt=H_0$ .

This nodal Hubble constant represents the upper time boundary as the mirror of the wormhole Weyl frequency  $f_{weyl}=E_{weyl}/h$  as the source energy quantum of the QBBS.

The inflaton defined the size of the 11-dimensional universe in the nodal Hubble bound as the number of space quanta contained in the Riemann toroidal surface  $V_H=2\pi^2R^3$  and as H is known from the googolplex algorithm obtained from the Mathimatia of the time space plenum

$$V_H = 2\pi^2R^3 = H \cdot 2\pi^2(r_{weyl})^3 = H(2\pi^2)(\lambda_{weyl}/2\pi)^3 \text{ for}$$

$$R_H = \sqrt[3]{(H)(\lambda_{weyl}/2\pi)} = 1.003849093 \times 10^{49} (10^{-22}/2\pi) = 1.597675453 \times 10^{26} \text{ m}^*$$

or 16.87610655 Billion lightyears for the Weyl wormhole perimeter of the QBBS

$$\lambda_{weyl} = 2\pi r_{weyl} = 10^{-22} \text{ m}^*$$

This then also defines the nodal Hubble constant  $H_0$  as the upper boundary of the inflaton hyperspace as  $H_0=c/R_H=1.877728042 \times 10^{-18}$  [Hz or 1/s]\*

The inflaton wave matter speed is then the tachyon speed as the Guth-Weyl inflaton for inflaton velocity  $v_{dB}=R_H f_{weyl}=4.79302635 \dots \times 10^{56}$  [m/s]\*

And the inflaton hyper-acceleration at instanton time as the Guth-Inflaton wave speed phase acceleration  $a_{dB}=R_H f_{weyl}^2=1.437907905 \dots \times 10^{87}$  [m/s<sup>2</sup>]\*

The inflaton then connects the birth of the universe at the instanton with the death of the universe as a rebirth in the ending of a first semi-cycle at the Hubble node as the size of the universe defined by the instanton-inflaton coupling.

This becomes the effect of the two wormhole images projected by the Hubble Horizon and its image in the shadow-mirror universe Khaibit back to the new created singularity of the QBBS, albeit now having a physical nature replacing the purely mathematical singularity of the mathematical point singularity of the Dirac magnetic monopole.

The inflaton mapped the Weylian wormhole onto a new north pole at the inside of the Witten membrane of the 11<sup>th</sup> dimension and this creation of space naturally became mirrored in creating the shadow-mirror space for Khaibit and a new south pole now no longer trapped in the infinity potential of the Dirac string but finitized in the existence of a physical universe expanding in a lower dimension under gravitational retardation and the laws of nature and oscillating with invariant lightspeed in a higher dimensional cosmology.

The 10-dimensional universe embedded itself in a multiverse of 3 spacial dimensions given by the Riemann manifold, with a time dimension conformally projecting the time connector dimensions 4, 7 and 10 to the 11<sup>th</sup> dimension of the Witten-Maria mirror across line spacetime as the 4<sup>th</sup> dimension with the 7<sup>th</sup> dimension of twistor spacetime and the 10<sup>th</sup> dimension of the quantum spacetime.

The connection between the 10<sup>th</sup> dimension of string spacetime in the quantum universe as a Dirichlet brane so forms the mirror image for the original 1<sup>st</sup> time dimension in line spacetime changing into a 1<sup>st</sup> space dimension with a quasi-spacetime in flatland for the second dimension assuming a time like nature to mirror the lower dimensional flatland in a higher dimensional flatland in a 11D-9D =2D dimensional root reduction.

The south pole in Khaibit so is also the south pole of the universe for a total extent of the inflaton as twice the Hubble event horizon and as three new singularities, each one separated from the adjacent one by one Hubble radius  $R_H$ .

This now renders the midpoint in the expansion of the universe at a radial displacement of  $\frac{1}{2}R_H$  as a rather special displacement coordinate, as at this point a new center for the universe must be defined to allow the Weyl wormhole of the QBBS to function as the south pole for the north pole at the intersection of the boundary of the Riemann universe with the Witten mirror.

The Riemann universe as a 3-dimensional surface volumar embedding a 7-dimensional twistor spacetime is also named as Baab or Gate or Mother Black Hole to distinguish it from an ordinary 3-dimensional volumar within a 4-dimensional spacetime volumar.

#### IV: The Dark Energy coupled to the Light Energy of a Shadow-Mirror Universe

This midpoint will be imaged in Khaibit and allow the manifestation of Dark Energy from the mirror universe to affect and participate in the cosmological evolution of the physical universe.

The displacement of the QBBS from a coordinate  $\frac{1}{2}R_H = \text{function}(n)$  must so define a scale factor for the expansion of the universe in the collinear two directions from the QBBS coordinate to the south pole in Khaibit and the north pole in Baab separated by precisely 4 Hubble radii, which geometrically become the total size of the 3-dimensional Riemann surface-volumar.

The timeless shadow universe in three imaged spacial dimensions so is defined as a projection of its information onto the surface boundary of a 3-dimensional surface as the Riemann volumar in time as the 4-dimensional spacetime of Minkowski, Riemann and Einstein and becomes the holographic universe of 't Hooft, Bekenstein, Thorn, Bousso, Maldacena and Susskind.

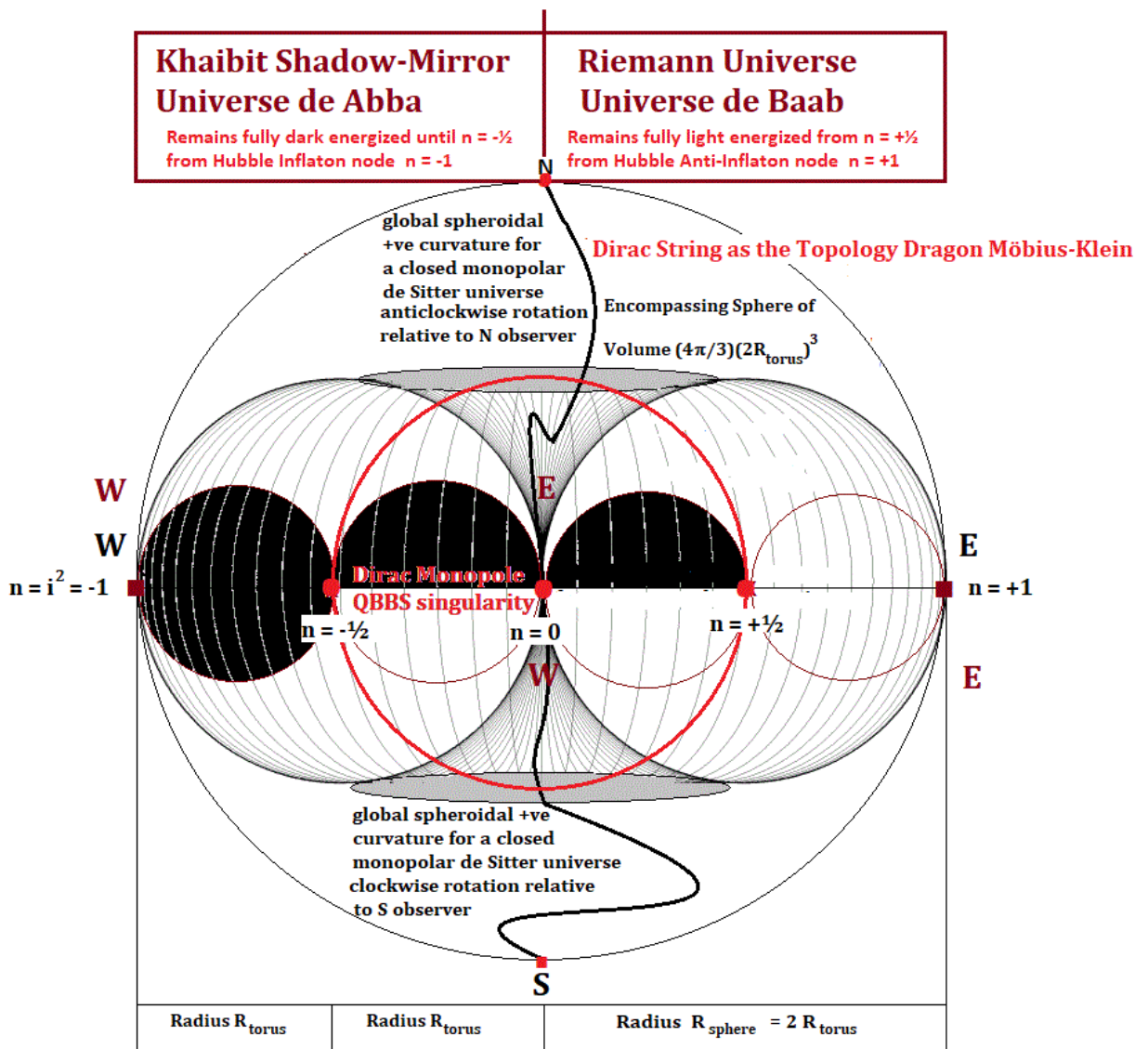

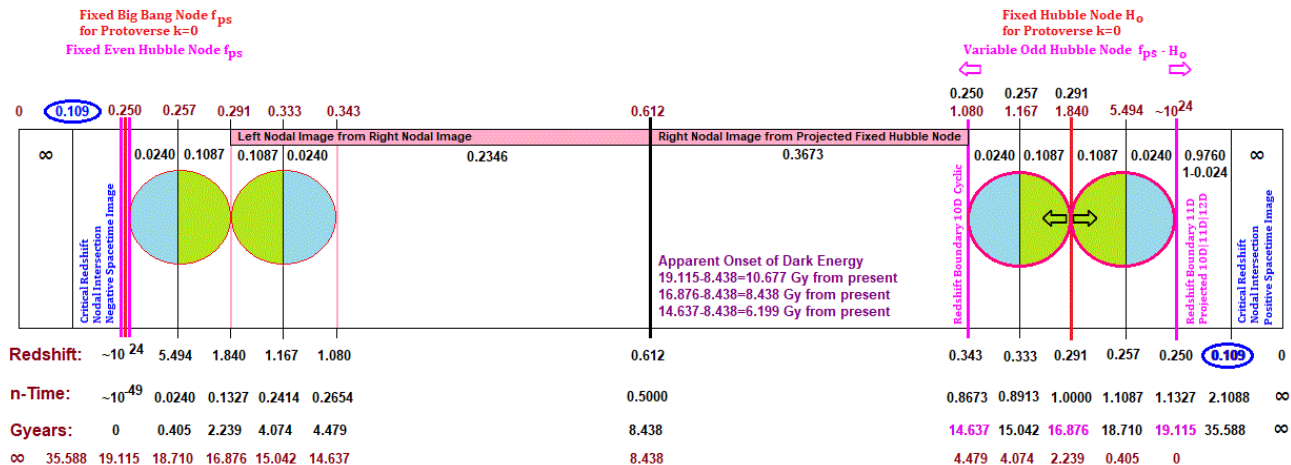

Universe Expansion into the Projected Future

Big Bang Genesis Observer for Increasing Redshift

⇒ Measured by Big Bang Genesis-Time Observer

⇒ ⇐

Universe Expansion into the Projected Past

Cosmic Wave Surfer for Increasing Redshift

Measured by Earth-Time Observer ⇐

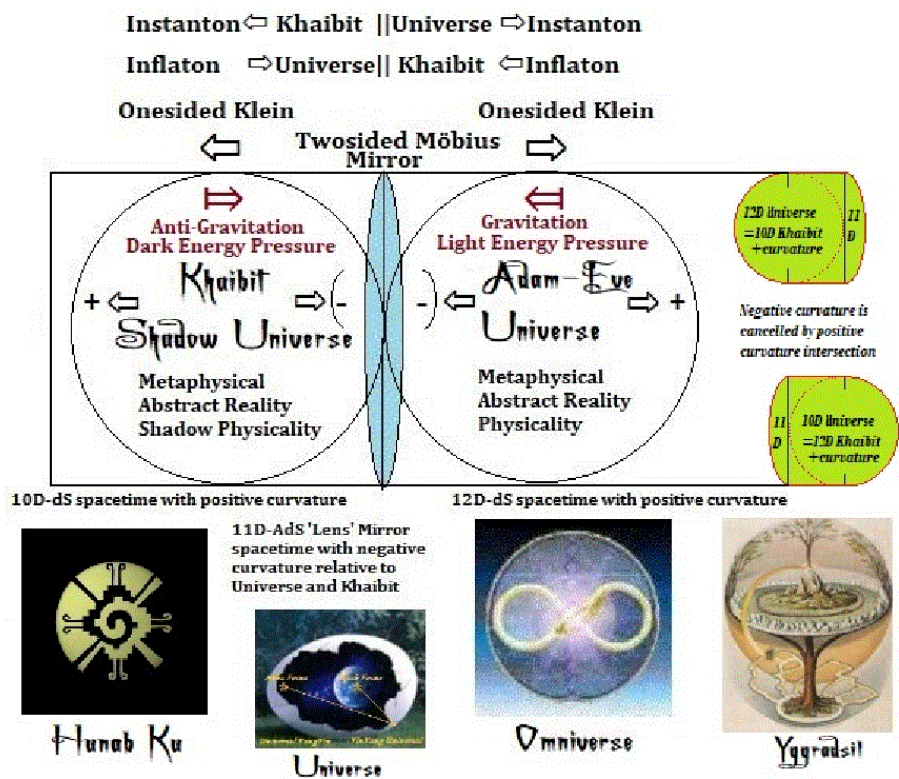

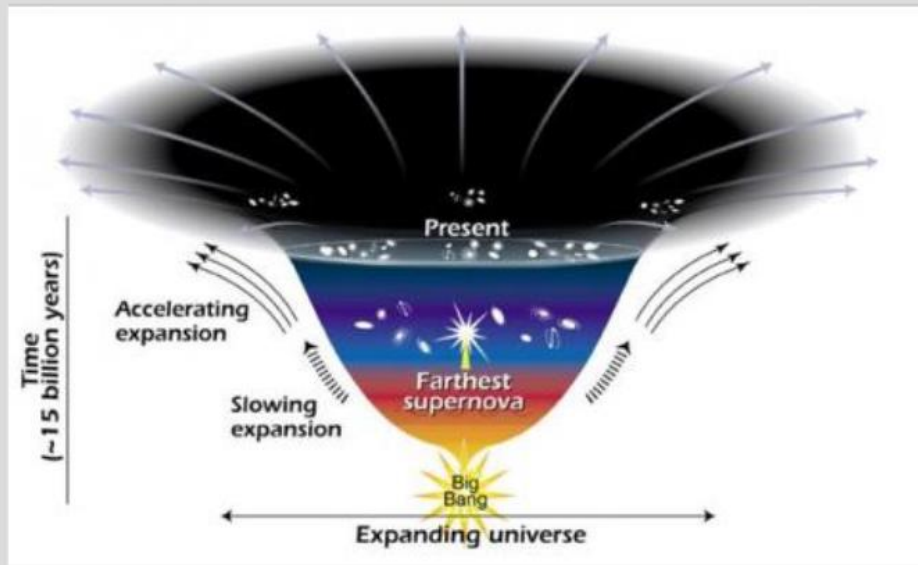

*Universe Dark Energy-1 Expanding Universe*

*This diagram reveals changes in the rate of expansion since the universe's birth 15 billion years ago. The more shallow the curve, the faster the rate of expansion. The curve changes noticeably about 7.5 billion years ago, when objects in the universe began flying apart as a faster rate. Astronomers theorize that the faster expansion rate is due to a mysterious, dark force that is pulling galaxies apart.*

*Credit: NASA/STSci/Ann Feild*



At the instanton  $t_{ps}$ , a de Broglie Phase-Inflation defined  $r_{max} = a_{dB}/f_{ps}^2$  and a corresponding Phase-Speed  $v_{dB} = r_{max} \cdot f_{ps}$ .

Those de Broglie parameters constitute the boundary constants for the Guth-Linde inflation and the dynamical behaviour for all generated multiverses as subsets of the omniverse in superspacetime CMF.

Initially, the de Broglie Acceleration of Inflation specified the overall architecture for the universe in the Sarkar Constant  $\Lambda_S = \Lambda_E(n_{ps}) r_{max} / a_{dB} = G_O M_O / c^2$   
 The Sarkar Constant calculates as 72.4 Mpc,  $2.23541620 \times 10^{24}$  m or as 236.12 Mlightyears as the bounding gravitational distance/scale parameter.

A Scalar Higgsian Temperature Field derives from the singularity and initialises the consequent evolution of the protocosmos in the manifestation of the bosonic superbranes as macroquantisations of multiverses in quantum relativistic definitions.

The Omega of critical density is specified in acceleration ratio  $\Lambda_E(n_{ps}) / a_{dB}$ , which is  $G_O M_O / c^2 r_{max} = 0.01401506 = \frac{1}{2} M_O / M_\infty = \frac{1}{2} \Omega_O = q_O$  (Deceleration Parameter).

$$\frac{2G_O M_O}{c^2} \frac{2c^2}{R_H^2} = \frac{4c^2 G_O M_O}{R_H R_H c^2} = \Omega_O 2cH_O \quad \Omega_O = 0.02803$$

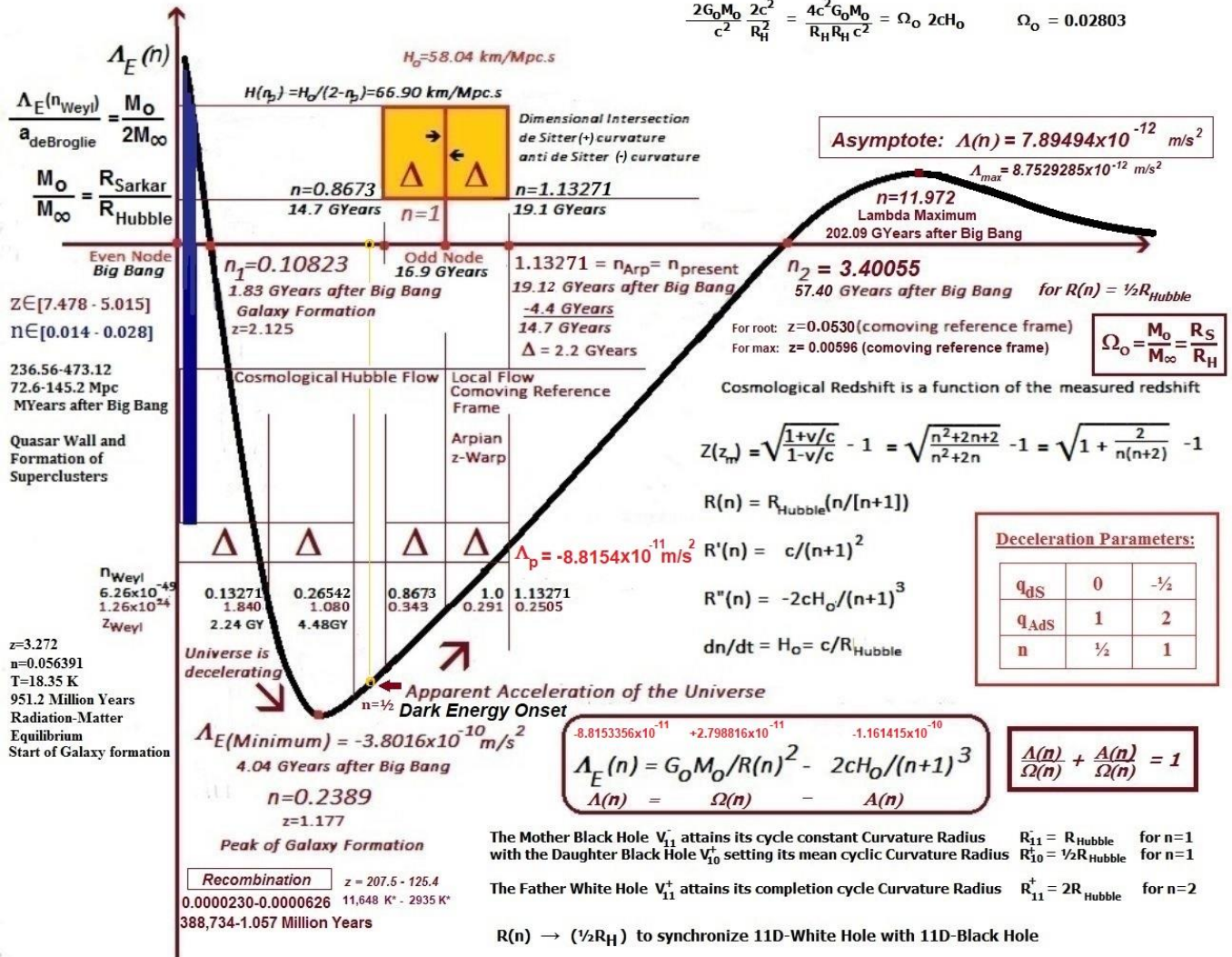

$z=3.272$   
 $n=0.056391$   
 $T=18.35 \text{ K}$   
 951.2 Million Years  
 Radiation-Matter  
 Equilibrium  
 Start of Galaxy formation

Quasar Wall and  
 Formation of  
 Superclusters

236.56-473.12  
 72.6-145.2 Mpc  
 MYears after Big Bang

$z \in [7.478 - 5.015]$   
 $n \in [0.014 - 0.028]$

Galaxy Formation

14.7 GYears

19.1 GYears

16.9 GYears

1.83 GYears

1.840

2.24 GY

$n_{Weyl}$

$z_{Weyl}$

$n_{Weyl}^{-49}$

$6.26 \times 10^{-24}$

$1.26 \times 10^{-24}$

0.13271

0.26542

0.8673

1.0

1.13271

0.343

0.291

0.2505

0.943

0.291

0.2505

0.2505

0.2505

0.2505

0.2505

0.2505

0.2505

0.2505

# The Big Bang Observer with the Cosmic Wave Surfer and the Hubble Multiverse

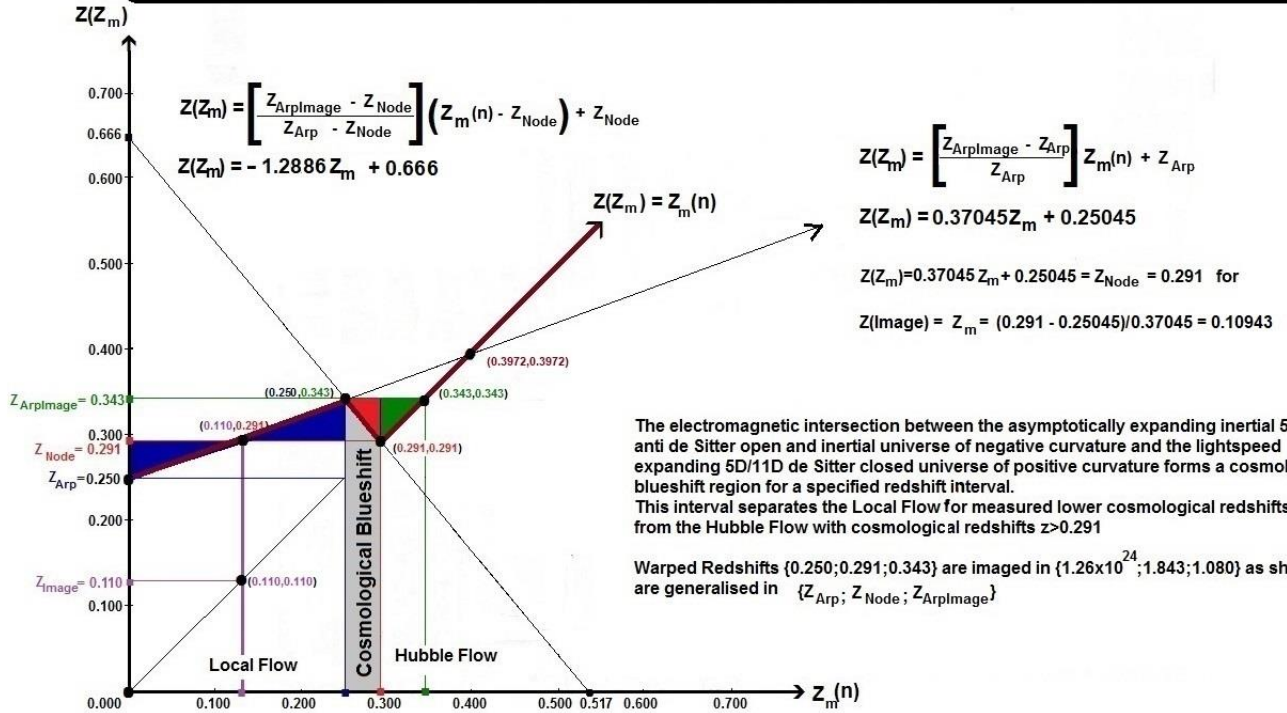

The electromagnetic intersection between the asymptotically expanding inertial 5D/11D anti de Sitter open and inertial universe of negative curvature and the lightspeed expanding 5D/11D de Sitter closed universe of positive curvature forms a cosmological blueshift region for a specified redshift interval. This interval separates the Local Flow for measured lower cosmological redshifts  $z < 0.251$  from the Hubble Flow with cosmological redshifts  $z > 0.291$

Warped Redshifts  $\{0.250; 0.291; 0.343\}$  are imaged in  $\{1.26 \times 10^{24}; 1.843; 1.080\}$  as shown and are generalised in  $\{Z_{Arp}; Z_{Node}; Z_{ArpImage}\}$

The intersection of the Local Flow cosmological redshift correction line for low redshifts  $z$  with the nodal redshift constant line determines a measured redshift  $z(m)$  as  $z(m) = z(image) = 0.109$  as a critical value for the Hubble Flow for high redshifts. For this value of  $z$  then particular unexpected cosmological phenomena, such as quasar redshift anomalies apparently coupling quasar sources with galactic hosts and aberrant spectra and light curves for gamma ray bursters and supernovae can be observed by Terran stargazers unaware of the multivalued redshift regions and their mirroring properties as indicated.

$$H_0 = dn/dt = c/R_{Hubble} = n/t = n_{BB}/t_{BB} = n_{Weyl}/f_{Weyl} = \lambda_{Weyl}/f_{Weyl}/R_{Hubble}$$

$$H_{0max} = f_{Weyl} = 3 \times 10^{30} \text{ Hz} \quad H(n_{present}) = H_0/(2-n_{present}) = 66.9 \text{ km/Mpcs} \quad H_{0min} = 58.04 \text{ km/Mpcs} = 1.877 \dots \times 10^{-18} \text{ Hz}$$

The Big Bang observer, say an Earth astronomer perceives and measures the receding event horizon of the Hubble node in witnessing hisher future with increasing cosmological redshifts  $z$  from left to right.

The Big Bang observer remains stationary relative to the Cosmic Wave surfer and measures the latter in receding from herhis recession velocity or decreasing speed due to gravitational mass attraction

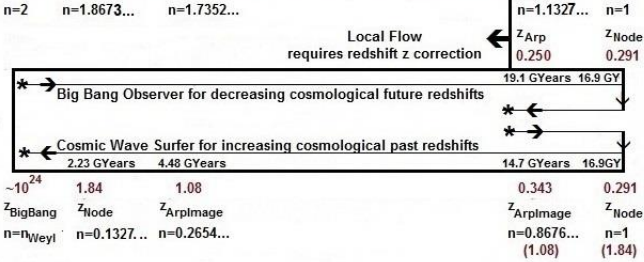

The Cosmic surfer rides the wavefront of the expanding universe in a comoving reference frame of the Arpian velocity defining the Arpian cosmological redshift. Shehe so observes the cosmic evolution as a witness for the past in the increasing of the warping effect towards the Big Bang and where the 11D/5D closed de Sitter universe coincided with the 10D/5D open anti de Sitter universe. The increase of the redshifts then proceeds from the right to the left in mirroring the timearrow of the Big Bang observer.

The dynamic node moves the Hubble event horizon along the basic  $n$ -interval  $[0, n_{BB}, 1]$  to superpose the 11D Radius  $R_{11}(n) = nR_{Hubble} = R_{Hubble} + \Delta$  onto the oscillating multiverse bouncing between even nodes of the Big Bang observer  $\{0, n_{BB}, 2, 4, 6, \dots\}$  and the odd nodes of the mirrored and imaged Cosmic wave surfer  $\{1, 3, 5, 7, \dots\}$ . The unitary interval so defines the curvature in  $R_{10}(n) = R_{Hubble} \{n/[n+1]\}$  asymptotically and as a function of the expansion parameter  $a = R_{10}(n)/R_{Hubble} = n/[n+1] = 1 - 1/[n+1]$

**Recessional Velocity:**  $v'/c = 1/(n+1)^2$  in  $1+z = \sqrt{\{(1+[v'/c])/(1-[v'/c])\}} = \sqrt{\{1 + 2/(n[n+2])\}}$  for  $n = \sqrt{(c/v')} - 1 = \sqrt{\{1 + 2/(z[z+2])\}} - 1$

$v'/c = 1/(n_p + 1)^2 = 0.219855$  for  $Z_{Arp} = 0.25045$  for a present  $z=0$  redshift image for  $n_p = 1.132711 = 1 + 0.132711$  and  $2 - 1.132711 = 0.867289$  (image)

**Critical Redshifts:**  
 $Z_{o/arp} = 0.00000$  for  $n_p = 1.132711$  and imaged in the limiting  $Z_{n\Delta} = 0.34323$  for the Local Flow LF  
 $Z_{M231} = 0.04147$  for a LF- $n = 3.96225$  for a redshift correction  $Z_{M231}(0.04147) = 0.37045(0.04147) + 0.25045 = 0.26581$  for a  $n = 1.07864$  and  $n_p = 1.07864 = 0.05407$  as 912.5 Million ly  
 $Z_{LF} = 0.10943$  for  $n = 2.108730$  for a 'Local Flow' redshift correction  $Z_{LF}(0.10943) = 0.37045(0.10943) + 0.25045 = 0.29099 = Z_n$  at the node for a  $n = 1 = n_p = 0.132711$ , 2.24 Gly from  $n_p$   
 $Z_{Q3C273} = 0.1583$  with  $v'/c = 0.1459$  and for a  $n = 1.6180$  for a redshift correction  $Z_{Q3C273}(0.1583) = 0.37045(0.1583) + 0.25045 = 0.30909$  for a  $n = 0.94993 = 1 - 0.05007$

The position of Blazar Q3C273 is so  $1.132711 - 0.94993 = 0.18278$  from the  $n_p$  cycle coordinate at a displacement of  $2.9202 \times 10^{25} \text{ m}^*$  or 3.0846 Billion light years from  $n_p$   
 The nodal mirror of the Inflaton defines a redshift displacement of 2.24 Billion years from the present observer for multiple redshift values for yleimic objects within the Local Flow.

$Z_{Arp}(0.25045) = 0.37045(0.25045) + 0.25045 = 0.34323 = Z_{n\Delta}$  for a  $n = 0.867289$  for  $n_p = 0.867289 = 0.265422$  and a distance of 4.479 Billion light years from  $n_p$  imaging  $Z_{n\Delta}$   
 $Z_n = 0.29099$  for  $n = 1.000000$  in Hubble Flow for  $Z_n(0.29099) = 0.29099$  for  $n_p = 1.0000 = 0.132711$  and a distance of 2.240 Billion light years from  $n_p$   
 $Z_{n\Delta} = 0.34323$  for  $n = 0.867289$  in Hubble Flow for  $Z_{n\Delta}(0.34323) = 0.34323$  for  $n_p = 0.867289 = 0.265422$  and a distance of 4.479 Billion light years from  $n_p$   
 $Z_{n\Delta} = 1.07994$  for  $n = 0.265422$  in Hubble Flow for  $Z_{n\Delta}(1.07994) = 1.07994$  for  $n_p = 0.26544 = 0.86727$  and a distance of 14.636 Billion light years from  $n_p$   
 $Z_{ni} = 1.84012$  for  $n = 0.132711$  in Hubble Flow for  $Z_{ni}(1.84012) = 1.84012$  for  $n_p = 0.13271 = 1.00000$  and a distance of 16.876 Billion light years from  $n_p$

The Dark Energy equation for the Inflaton was defined as a multiversal summation of the protoverse encompassed by the omniverse in the Mathimatia:

## Dark Energy DE-Quintessence $\Lambda_k$ Parameters:

A general dark energy equation for the  $k^{\text{th}}$  universe ( $k=0,1,2,3,\dots$ ) in terms of the parametrized Milgröm acceleration  $A(n)$ ; comoving recession speed  $V(n)$  and scale factored curvature radius  $R(n)$ :

$$\Lambda_k(n) = G_o M_o / R_k(n)^2 - 2cH_o(\Pi n_k)^2 / \{n - \Sigma \Pi n_{k-1} + \Pi n_k\}^3$$

for negative Pressure  $P(n=H_o t) = c^2 H_o^2 (2n+1) / \{4\pi G_o T(n)^2\} - M_o c^2 / R(n)^3$  for the spherical  $V_{ds} = 4\pi R(n)^3 / 3$   
and  $P(n=H_o t) = c^2 H_o^2 (2n+1) / \{6\pi^2 G_o T(n)^2\} - M_o c^2 / R(n)^3$  for the hyper-spherical  $V_{ds} = 2\pi^2 R(n)^3$

$$\Lambda_k = \{G_o M_o (n - \Sigma \Pi n_{k-1} + \Pi n_k)^2 / \{(\Pi n_k)^2 \cdot R_H^2 (n - \Sigma \Pi n_{k-1})^2\} - 2cH_o(\Pi n_k)^2 / \{n - \Sigma \Pi n_{k-1} + \Pi n_k\}^3\}$$

$$\Lambda_o = G_o M_o (n+1)^2 / R_H^2 (n)^2 - 2cH_o / (n+1)^3$$

$$\Lambda_1 = G_o M_o (n-1+n_1)^2 / n_1^2 R_H^2 (n-1)^2 - 2cH_o n_1^2 / (n-1+n_1)^3$$

$$\Lambda_2 = G_o M_o (n-1-n_1+n_1 n_2)^2 / n_1^2 n_2^2 R_H^2 (n-1-n_1)^2 - 2cH_o n_1^2 n_2^2 / (n-1-n_1+n_1 n_2)^3$$

.....

For the protoverse  $k=0$  then,  $\Lambda_o = G_o M_o (n+1)^2 / R_H^2 (n)^2 - 2cH_o / (n+1)^3$  had been a boundary condition at the time instanton  $t_{ps}$  as the quantum of mass  $m_{ss}$  in  $f_{ss} = m_{ss} c^2 / h = 1 / f_{ps} = t_{ps}$ .

All mass is quantized in  $m = \Sigma m_{ss} = N m_{ss}$  and  $1 / f_{ss}^2 = f_{ps}^2$  eigen states in  $9 \times 10^{60}$  permutations to  $m f_{ss}^2 / m_{ss} = m E_{ss} / m_{ss} h f_{ps} = m \cdot m_{ss} c^2 / m_{ss} E_{ps} = m c^2 / m_{ps} c^2 = m / m_{ps}$ .

Any mass  $m$  is so quantum gravitationally quantized in a mass eigen frequency  $f_{ss}$  in the time instanton as the inverse of the source frequency  $f_{ps}$  as a distribution of permutational self-states  $f_{ps}^2 |_{\text{mod}} = 9 \times 10^{60}$ .

The cycle time  $n=H_o t$  for the nodal Hubble constant  $H_o = c / R_H = dn / dt$  at the Instanton so had been  $n_{ps} = H_o t_{ps} = c t_{ps} / R_H = c / R_H f_{ps} = c / V_{dB} = \lambda_{ps} / R_H = 6.26 \times 10^{-49}$  as a proportionality relating the minimum conditions of the Instanton to the maximum conditions of the Inflaton in the form of wavelength and velocity.

$\Lambda_o(n_{ps}) = G_o M_o (n_{ps}+1)^2 / R_H^2 (n_{ps})^2 - 2cH_o / (n_{ps}+1)^3$  calculates as  $\Lambda_o(n_{ps}) = \{G_o M_o / R_H^2\} \{R_H f_{ps} / c\}^2 = G_o M_o / \lambda_{ps}^2$  for this Lambda- or Dark Energy acceleration and proportional to the hyper-acceleration of the Inflaton as  $\Lambda_o(n_{ps}) / a_{dB} = \{G_o M_o / \lambda_{ps}^2\} / \{R_H f_{ps}^2\} = \{G_o M_o / \lambda_{ps}^2\} / \{2G_o M_H f_{ps}^2 / c^2\} = \{M_o / 2M_H\}$  as  $c = f_{ps} \cdot \lambda_{ps}$  as the de Broglie group-wave velocity.

A group velocity for waves is upper limited by light speed 'c'; whilst a phase velocity for waves is lower limited by 'c' as a superluminal or tachyonic speed for matter waves in

$$v_{\text{phase}} = f \lambda = \{m c^2 / h\} \{h / m v_{\text{group}}\} = \{c^2 / v_{\text{group}}\} > c \quad \forall \quad v_{\text{group}} < c.$$

And so half of the Black Hole Mass parameter  $\Omega_o = M_o / M_H$  defines the Black Hole mass differential in the acceleration differential between the Dark Energy DE and the hyper-acceleration  $A_{dB}$  of the Inflaton as Deceleration parameter  $q_o = \frac{1}{2} \Omega_o = G_o M_o H_o / c^3 = G_o M_o / R_H c^2 = \Lambda_o / A_{dB}$ .

Applying this gradient to the Instanton then reduces the time instantaneity

$t_{ps} = 1 / f_{ps} = f_{ss}$  in  $q_o t_{ps} = n_{ps} \cdot \{G_o M_o / c^3\}$  to create a 'Higgs Potential False Vacuum' or HPFV within the Inflaton-Instanton epoch of the superstrings.



"The idea of an antigravity force has had a bad rep ever since," says Kirschner. "People sort of flinched when it was mentioned, usually because it meant they couldn't explain their results." So when Riess, having checked his figures, suggested this might be the reason he kept showing negative mass, Kirschner, in quiet desperation, emailed the whole team, saying, "In your heart of hearts, you know this can't be right! We have got to find out where the error is."



"In your heart you know this is wrong." Really, it just seemed like a terrible result, a horrifying thing

GETTING IT RIGHT 219  
the writing assignments. So we all gave him advice. Conflicting advice. After all, this was a collaboration, not an army. I didn't like the result. I didn't think we were smarter than Einstein and he had tripped on the cosmological constant. I did not want to make a mistake. I had liked being wrong about the progenitor of SN 1987A and I did not want to be wrong about the history of cosmic expansion. On 12 January 1998 (at 10:18:31 a.m.) I wrote:  
I am worried that the first cut looks like you might need some lambda. In your heart, you know this is wrong, though your head tells you that you don't care and you're just reporting the observations. ... It would be very silly to say "we MUST have nonzero lambda" only to retract it next year.

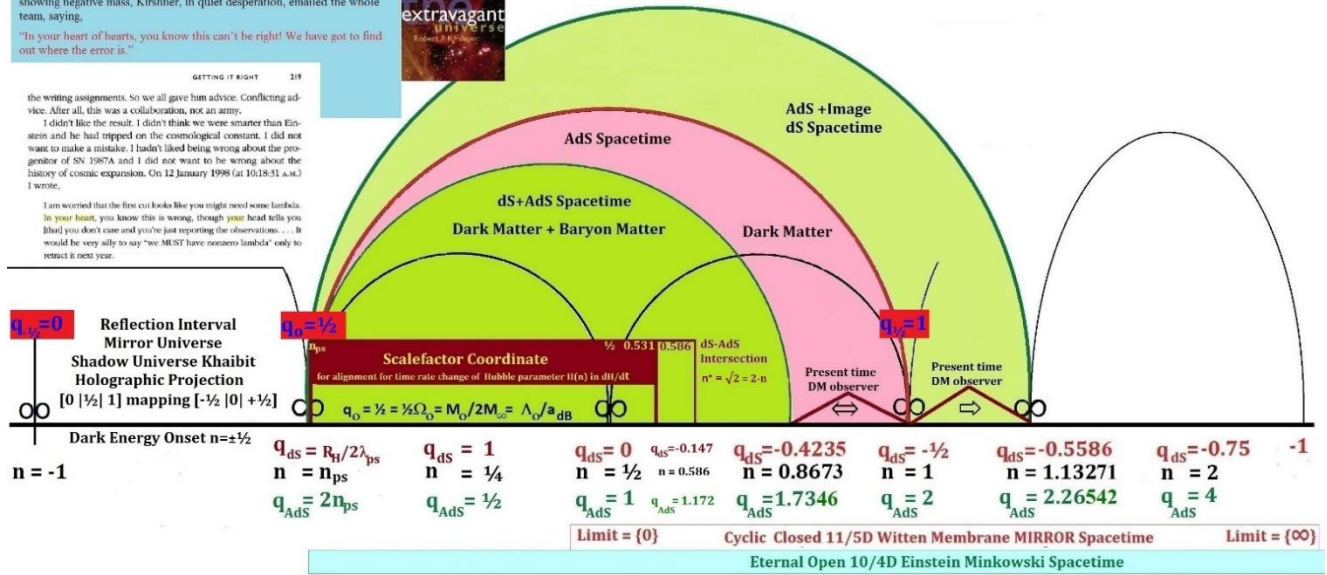

Deceleration Parameter  $q(n) = -(d^2a/dt^2)/|a|/(da/dt)^2$   
 $q_{AdS}(n) = \{-2cH_0/[n+1]\}^2/[c/(n+1)]^2 = 2nH_0/c = 2n$   
 $q_{ds}(n) = 1/q_{AdS} - 1 = 1/2n - 1 = (1-2n)/2n$

$q_{ds} = 1/2n - 1$   
 $q_{AdS} = 2n$

Continuity in Cyclic Resets of the Initial-Boundary parameters  
 $\Lambda(n) = G_0 M_0 / R(n)^2 - 2cH_0 / [n+1]^3$   
 $\Lambda(n)/R(n) = G_0 M_0 / R(n)^3 - 2H_0^2 / [n+1]^2$   
 $-P(n) = \frac{M_0 c^2}{R(n)^3} - \frac{(2n+1)c^2 H_0^2}{4n G_0 T(n)^2}$

$q_{ds} \cdot q_{AdS} = 2n(1/2n - 1) = 1 - 2n$

$\frac{q_{ds} + q_{AdS}}{q_{ds} - q_{AdS}} = \frac{1 - 2n + 4n^2}{1 - 2n - 4n^2} = \frac{4\{n-1/4(1+i\sqrt{3})\} \cdot \{n-1/4(1-i\sqrt{3})\}}{-4\{n-1/4(1-\sqrt{5})\} \cdot \{n-1/4(1+\sqrt{5})\}}$

$\{q_{ds} + q_{AdS}\}$  are  $1/2$  roots for  $T(n)=1$  in  $n(n+1)+1=0$   
 $n = -1/4(1+i\sqrt{3})$  ;  $n = -1/4(1-i\sqrt{3})$   
 $\{q_{ds} - q_{AdS}\}$  are  $1/2$  roots for  $T(n)=-1$  in  $n(n+1)-1=0$   
 $n = 1/4(\sqrt{5}-1) = 1/2X$  ;  $n = -1/4(\sqrt{5}+1) = -1/2Y$

The cosmological observer is situated simultaneously in 10/4D Minkowski Flat dS spacetime, presently at the  $n=0.8676$  cycle coordinate and in 11/5D Mirror closed AdS spacetime, presently at the  $n=1.1327$  coordinate.

Observing the universe from AdS will necessarily result in measuring an accelerating universe; which is however in continuous deceleration in the gravitationally compressed dS spacetime for deceleration parameter  $q_{AdS} = 2n$ . Gravitation is made manifest in the dS spacetime by Graviton strings from AdS spacetime as Dirichlet branes at the 10D boundary of the expanding universe mirroring the 11D boundary of the nodally fixed Event Horizon characterised by  $H_0 = c/R_H$

The Dark Matter region is defined in the contracting AdS lightpath, approaching the expanding dS spacetime, but includes any already occupied AdS spacetime. The Baryon seeded Universe will intersect the 'return' of the inflaton lighpath at  $n=2-\sqrt{2}=0.586$  for (DM=22.09 %; BM=5.55%; DE=72.36%).

The Dark Energy is defined in the overall critical deceleration and density parameters; the DE being defined in the pressure term from the Friedmann equations and changes sign from positive maximum at the inflaton-instanton to negative in the interval  $\Lambda(n)>0$  for  $n$  in  $[n_{ps} - 0.18023]$  and  $\Lambda(n)> 3.4008$  with  $\Lambda(n)<0$  for  $n$  in  $(0.1803 - 3.4008)$  with absolute minimum at  $n=0.2389$ .

This DE (quasi)pressure term for the present era (1-0.1498 for 85% DM of Matter 4.834% BM; 27.434% DM; 67.732% DE) is  $\Lambda_p = -1.4004 \times 10^{-10} \text{ J/m}^3 < 0 \nabla n$  and is integrated into a Lambda quintessence of  $1.039 \times 10^{-36} \text{ s}^{-2}$  and from  $\Lambda(n_p) = -8.815 \times 10^{-11} \text{ m/s}^2$

This pressure term will become asymptotically negative for a universal age of about 57.4 Gy and for a zero curvature evolution of the cosmos within the multiverse generations.

The dimensionless acceleration ratio  $q_0 = \Lambda_0 / \Lambda_{dB} = M_0 / 2M_H = 1/2 \Omega_0$  assumes the value  $q_0 = 1/2$  for  $n = 1/3$  and when the radial size of the universe is at halfway nexus at  $1/4 R_H$  for the intersection coordinate between the AdS lightspeed invariant expansion and the Dark Energy onset at redshift  $z = 0.6124$  for the dS gravitationally retarded cosmology and for  $R(1/2) = 1/2 R_H [1+1/2] = 3/4 R_H$

The coordinate  $1/2 R_H = \text{function}(n)$  for the expansion of the universe in the instanton-inflaton coupling with scale factor  $a$  is  $R(n) = aR_H = R_H/(n+1)$  for a scale factor  $a = n/(n+1)$  with  $dn/dt = H_0$  and parametrization for velocity  $v_H(n)$   
 $v_H(n) = dR(n)/dt = (dR/dn) \cdot (dn/dt) = R_H H_0 / (n+1)^2 = c / (n+1)^2$  and a parametrization of acceleration  $a_H(n)$   
 $a_H(n) = d^2R(n)/dt^2 = (dv_H(n)/dn) \cdot (dn/dt) = -2R_H H_0^2 / (n+1)^3 = -2cH_0 / (n+1)^3$

Then for  $n=1/2$ , the Hubble radius for the higher dimensional universe will be the invariant light path of the EMMR, travelling at light speed  $c$  for a displacement from the QBBS of  $nR_H=1/2R_H$ . and being emitted from the first wormhole coordinate of the instanton as the inflaton.

The end of the inflation period is however defined in the Weyl wormhole frequency of  $f_{weyl}=c/\lambda_{weyl}=3 \times 10^{30}$  [Hz]\* for an inverse time  $t_{weyl}=3.333... \times 10^{-31}$  [s]\* defining the time coordinate for the second wormhole at the Hubble event horizon reflecting or imaging the light path of the inflaton's EMMR to then meet and intersect the instanton's light path at cycle coordinate  $n=1/2$   $t_{weyl}$  [s]\* after the instanton's light path had reached this  $n$  cycle coordinate.

The lower dimensional light path  $R(n)=ct=nc/H_0$  is equal to the light path of the EMMR so just for a time  $t_{weyl}$ , after which the EMMR light path continues to increase the separation between the two displacements due to the gravitational retardation of the initial QBBS initial boundary conditions for the energy-matter-charge content of the universe.

For cycle coordinate  $n=1$ , the EMMR light path has reached the Hubble node, but the expansion of the lower dimensional universe under scale factors  $a=n/(n+1)=1/(1+1)=1/2$  defines the critical halfway point for the onset of the dark energy from Khaibit and the shadow universe intersecting the light energy of the Riemann universe Baab.

The size of the universe at cycle coordinate  $n=1$  is  $R(1)=1/2R_H=7.988377265 \times 10^{25}$  [m]\* or 8.438053275 Gly for a 'civil year' of 365.2425 mean solar days and 1 Billion lightyears equal to 1 Gly.

The size of the universe at cycle coordinate  $n=1/2$  is  $R(1/2)=(1/2 \cdot 2/3)R_H=1/3R_H=5.325584843 \times 10^{25}$  [m]\* or 5.62536885 Gly.

The dark energy so began to interact with the light energy 5.625 billion years after the Quantum Big Bang Singularity as the QBBS.

The time marker for the EMMR meeting the 11-dimensional boundary so is.

$1/H_0 = 5.325584843 \times 10^{17}$  [s]\* or a light path of 16.8761 Billion lightyears for a 'civil' year of 365.2425 mean solar days. When this event occurs, the EMMR will both refract and reflect its light path. The refraction will define a new 11-dimensional boundary in moving the Witten mirror into a previously undefined part of the spacetime created by the inflaton-instanton coupling, however defined in the timespace of the monopolar singularity as the precursor for the QBBS coupled to the Dirac string.

This event will naturally become imaged in the 12-dimensional Vafa omni spacetime of Khaibit as the shadow-mirror universe and the reflection of the light path of the EMMR will begin a return journey to meet the asymptotically expanding Anti de Sitter universe in a baryonic dark matter intersection nexus.

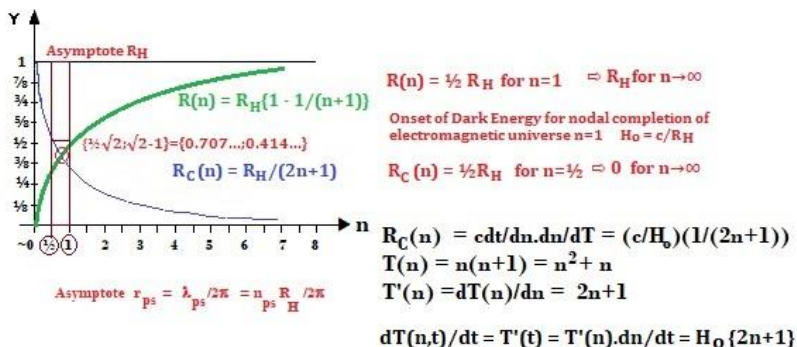

The nexus point for the evolution of the seedling universe as a protoverse so is defined as the intersection of the EMMR light path beginning its journey from the wormhole of the instanton and ending it at the location of the wormhole of the inflaton one half-cycle of period  $1/H_0 = R_{\text{Hubble}}/c = 16.876$  billion lightyears.

At this cycle time coordinate a second universe was born from the instanton in the creation of a multiverse from the seedling universe.

This second universe is collocal with the protoverse, but its initial boundary parameters are a function of the seedling parameters depending on a superposed asymptotic cosmology for the protoverse to have completed its evolution in spacetime in satisfying its boundary conditions set in the generating timespace of the imaginary space, albeit ordered in principalities of time as events as definitions.

{ [https://www.academia.edu/39210286/The Origins of the Mathimatia and Four Pillars of Creation](https://www.academia.edu/39210286/The_Origins_of_the_Mathimatia_and_Four_Pillars_of_Creation)  
[https://www.academia.edu/39210282/The Beginning of Nowhere in Notime](https://www.academia.edu/39210282/The_Beginning_of_Nowhere_in_Notime)  
[https://www.academia.edu/39210281/The Beginning of Space in Time](https://www.academia.edu/39210281/The_Beginning_of_Space_in_Time)  
[https://www.academia.edu/39110880/The Eternal Void Exists as Unity Everything or All That Is](https://www.academia.edu/39110880/The_Eternal_Void_Exists_as_Unity_Everything_or_All_That_Is) }

The evolution of the multiverse, embedded in an omniverse is based on the nature of the QBBS as emerging from a wormhole singularity, physicalizing the Dirac monopole mathematical and one-dimensional originator from timespace.

All cosmological black holes are limited in their metric inertia in their Schwarzschild radii.

The entire universe is a 'Black Holed Hierarchy', but there are black holes evolving with the matter content of the universe as physicalized potentials of the QBBS and there are 'primordial' black holes such as the Weyl wormholes of the instanton-inflaton quantum entanglement.

Primordial black holes are known as 'Boundary' Black Holes' and those engage in their own black hole evolution as so called 'Extremal Strominger Branes'.

This allows definition of the Weyl wormhole as a Strominger boundary wormhole brane of the instanton and the QBBS and of a mass of  $m_{\text{weyl}} = \{\lambda_{\text{weyl}} c^2 / 4\pi G_0\} = 6445.7753 \text{ kg}^*$ .

The QBBS of the creation of spacetime so was seeded by the weight of about one large or two elephants in the gravitational field of the earth as about 6.5 metric tons. Strominger extremal black holes are massless in the sense that their wormhole masses can be expressed as frequency energy states in

$m_{\text{weyl}} = E_{\text{weyl}}/c^2 = hf_{\text{weyl}}/c^2 = k_B T_{\text{weyl}}/c^2$  and that such extremal black holes do not emit Hawking radiation in evaporating their matter content over the course of large cosmological time scales.

At the Quantum Big Bang instanton, a baryonic restmass seedling  $M_0$  of about  $1.814 \times 10^{51} \text{ kg}^*$  became distributed in spacetime vortices given in a de Broglie wave matter inflaton.

This inflaton defined the Hubble horizon as a wavefunction for the holistic holographic de Sitter universe and set a supercluster scale for a 'daughter black hole' known as a Sarkar Schwarzschild metric, embedded within a 'mother black hole' defined in the Hubble event horizon as a function of the total mass content of the QBBS as defined from the timespace and manifesting in spacetime.

The Sarkar black hole is an extremal black hole and forms the upper limit for gravitational scale interaction between galactic superclusters.

This shows that the universe will become isotropic and homogeneous beyond the supercluster scale and so manifest the 'Cosmological Principle' in the uniformity of the topology and structure of the universe in cosmological models. The distribution of inertia then takes the form of voids and textures akin a honeycomb geometry and where the individual 'cosmic cells' span across scales of about 470 million lightyears, which so define the Sarkar metric.

But the Sarkar Black Hole is extremal and so is a limiting Black Hole in having a mass  $M_0$  as the evolution of the wormhole mass of the QBBS. It does not exist as a 'normal' black hole, such as found at the core of galaxies, which describe a M-Sigma relation in a general ratio of 0.1%-0.2% between the galactic core inertia and the total galactic mass.

The overall black hole evolution takes about 4 trillion years as a Strominger brane to satisfy the boundary condition for the Sarkar black hole to become massless after the completion of the spacetime evolution of the Weyl brane of the instanton merging with the wormhole of the inflaton in the size of the mother black hole of the Hubble event horizon at the boundary of superstring spacetime in 10 dimensions to the intersection with the membrane spacetime of omnispacetime in the Witten-Maria mirror.

For  $r_{ps}$  to grow to the Hubble event horizon  $R_H$  in a time  $t=n/H_0=nR_H/c$ , the wormhole mass  $m_{ps}$  must increase in the n-cycle function for the gravitational parameter  $G(n)Y(n)=G_0M_0=G_0X^nM_0Y^n$  for  $(XY)^n=X^nY^n=1$  and this function is proportional to the increase of the wormhole radius for the instanton growing into the size of the Hubble event horizon as the mirror wormhole of the inflaton.

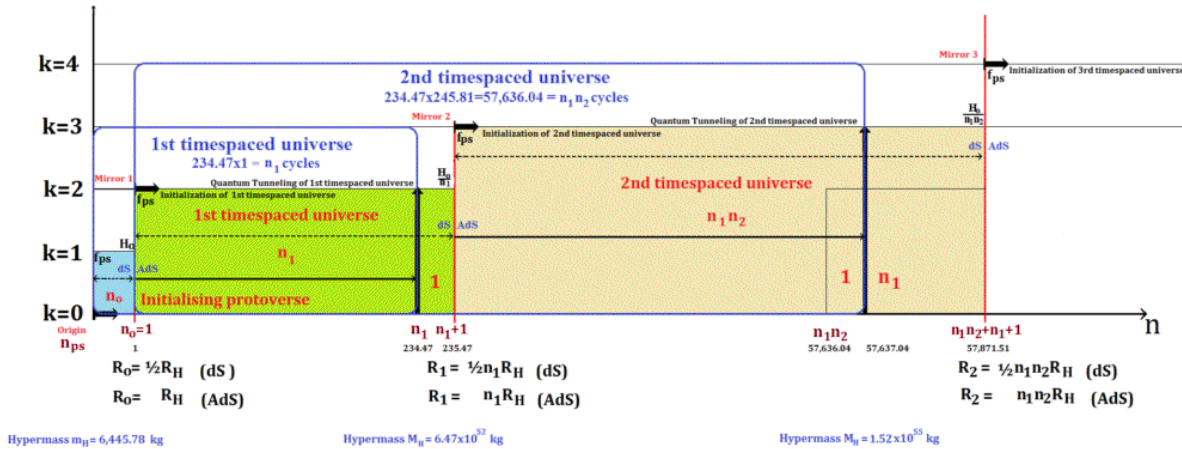

$$r_{ps} Y^n = R_H \text{ for } r_{ps} \cdot e^{n \ln Y} = R_H \text{ for } n \ln Y = \ln\{R_H/r_{ps}\} \text{ and}$$

$n_{critical} = \ln\{R_H/r_{ps}\}/\ln Y = \ln\{1.5977 \times 10^{26}/1.5916 \times 10^{-23}\}/\ln\{1.618034\}$   
 $= \ln(2\pi n_{ps})/\ln Y = 234.4715\dots$ , implying that 234.4715 Hubble cycles are required for the asymptotic expansion of the lower dimensional universe to enable the second universe, born when the EMMI light path reached the Witten-Maria mirror membrane of the 11<sup>th</sup> dimension to quantum tunnel into the subsequent universal cycle. As 234.4715 Hubble semi-cycles are  $234.4715 \times 16.876 \text{ Gy} = 3.957 \text{ Trillion years}$  for a time, the protoverse would be destined to exhaust its nuclear fuel supplied by stellar and galactic evolution and in the transmutation of the chemical and atomic elements.

Radius of Curvature  $r(n)$  with Salefactor  $1/a=1+1/n$  in  $dS$  as a function of cycletime coordinate  $n$

$$r(n) = r_{\max} \left( \frac{n}{n+1} \right) m^* \quad \text{and} \quad n = H_0 t$$

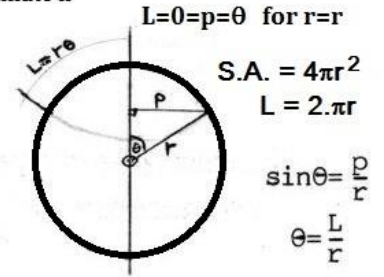

The volume of the 4-D spacetime can however be found by integrating the surface area S.A. via arclength  $L$ , with  $L$  being an intrinsic parameter of the 3-D surface.  $dL=r \cdot d\theta$

$$V_{\text{Universe}} = \int_0^{r\pi} 4\pi r^2 dL = 2\pi^2 r(n)^3 \quad \text{for a local spheroidicity}$$

$$4\pi \int_0^\pi r^3 \sin^2 \theta d\theta = 4\pi r^3 \int_0^\pi \frac{1}{2} (1 - \cos 2\theta) d\theta = 2\pi^2 r(n)^3 \quad \text{for the asymptotic 4/10D } dS \text{ 'flatness' cosmology within the nodal Hubble 5/11D AdS Universe}$$

This classical macrovolumar is quantized in the microvolumar quantum of the Unified Field in  $8\pi$  radians or  $840^\circ - (-600^\circ) = 1440^\circ$

$$\begin{aligned} \frac{1}{4}\pi \int_{-600^\circ}^{840^\circ} \{ \sin(\frac{1}{2}[3x]) - \cos(\frac{1}{4}[3x]) \}^2 dx &= \frac{1}{4}\pi \int_{-10\pi/3}^{14\pi/3} \{ \sin^2(3x/2) + \cos^2(3x/4) - 2\sin(3x/2)\cos(3x/4) \} dx \\ &= \frac{1}{4}\pi \int_{-600^\circ}^{840^\circ} \{ \frac{1}{2}(1 - \cos[3x]) + \frac{1}{2}(1 + \cos\frac{1}{2}[3x]) \cdot \sin\frac{1}{2}[9x] \cdot \sin\frac{1}{4}[3x] \} dx \\ &= \frac{1}{4}\pi \left[ \theta \cdot \sin[3x]/6 + \sin\frac{1}{2}[3x]/3 - 2\cos\frac{1}{2}[9x]/9 - 2\cos\frac{1}{2}[3x]/3 \right]_{-10\pi/3}^{14\pi/3} = \frac{1}{4}\pi(8\pi) = 2\pi^2 \end{aligned}$$

{ by classical volumar of revolution (vor)  $V_{\text{vor}} = \int \pi y^2 dx$  for  $y=r$  }

The amplitude for the universal wavefunction becomes proportional to the quantum count of the space occupancy of a single spacetime quantum and as source energy (VPE or Vortex Potential Energy) quantum and as a consequence of the preinflationary supersymmetry of the  $F(x) = \sin x + \sin(-x) = 0$  wavefunction defining this singularity (symbolised as the symbol for infinity).

A higher dimensional surface is Moebian connected to differentiate the quantum mechanical 'boundary' for the quantum tunneling of the macrocosmos as a magnified holofractal of the well understood microquantumization.

It then is the experienced and measured relativity of time itself, which becomes the quantum wall, with the 'reducing thickness' of the quantum boundary correlating with the evolution of the multiversal structure in the phase shifted time intervals defining the individual universes.

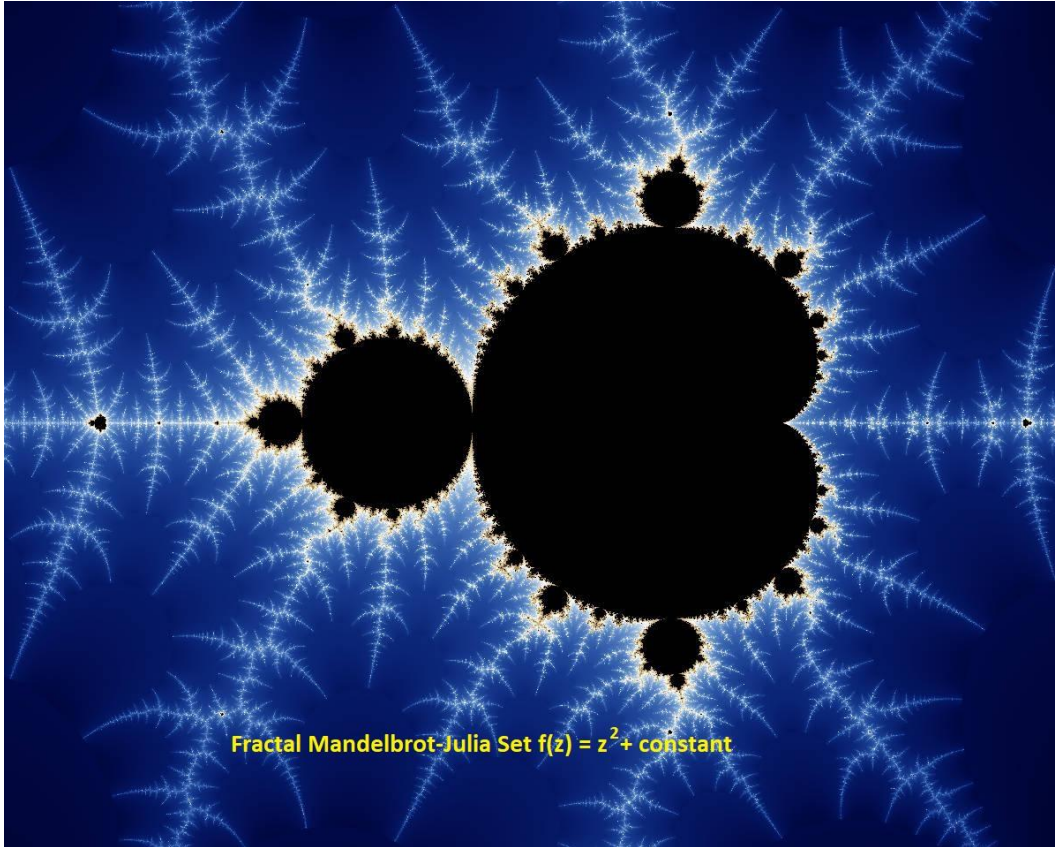

The generating complex function for the Mandelbrot-Julia sets, given in their most general form as  $f(z) = z^2 + z$  is mirrored in the n-cycle time function  $T(n)$  in the context of the Friedmann cosmology and the general evolution of the universe, reconfigured in the universal encompassing sense by the scale factor  $a(n) = n/(n+1)$ .

This scale factor relates directly to the definition of the natural exponent 'e' and the universal wavefunction  $B(n)$  as a function of the alpha finestructure with the n-cyclic formula  $T(n) = n(n+1) = n^2 + n$  to introduce the basic Mandelbrot complex function.

**The natural exponent e is defined in the inversion of scale parameter  $1/a = \{1 + 1/n\}$**

$e = \lim_{n \rightarrow \infty} \{1 + 1/n\}^n$  for  $e = \{1 + 1/n\}$  for  $x = 1 = hf/kT$  in Planck's Radiation Law for a Black Body

$e - 1 = 1/n$  for  $n = 1/[e - 1] = 1/Y^{n'} = X^{n'}$

$n' = \ln\{e - 1\} / \ln Y = 1.12492010..$   
for a time coordinate 0.0075 or  
about 126.58 Million years ago

$$e^{\frac{hf}{kT}} = 1 + \frac{1}{n} \quad \text{for} \quad n(f, T) = \frac{1}{e^{\frac{hf}{kT}} - 1} \quad (\text{Eq. \#26})$$

The critical density of the universe derives from the total mass density of the QBBS instanton-inflaton coupling as  $\rho_{\text{critical}} = M_{\text{universe}} / V_{\text{universe}} = M_H / 2\pi^2 R_H^3 = c^2 / 4\pi^2 G_0 R_H^2 = H_0^2 / 4\pi^2 G_0$  for the Riemann-Baob 3D-surface universe and as  $\rho_{\text{critical}} = (3\pi/2) H_0^2 / 4\pi^2 G_0 = 3H_0^2 / 8\pi G_0$  for the 3D-volumar universe.

## Primordial Mass-Charge definitions from the Logos Mathimatia in timespace

Electromagnetic Fine structure:  $\alpha_e = 2\pi k e^2 / hc = e^2 / 2\epsilon_0 hc = \mu_0 e^2 c / 2h$   
 $= 60\pi e^2 / h$  (Planck-Stoney-QR units \*)

Gravitational Fine structure (Electron):  $\alpha_g = 2\pi G_0 m_{\text{electron}}^2 / hc$   
 $= \{\alpha_g / \alpha_{\text{planck}}\} = \{m_{\text{electron}} / m_{\text{planck}}\}^2$

Gravitational Fine structure (Primordial Nucleon):  $\alpha_{\text{nucleon}} = 2\pi G_0 m_c^2 / hc$  for  $m_c$   
 $= m_{\text{planck}} \cdot \alpha_e^9$

Gravitational Fine structure (Planck Boson):  $\alpha_{\text{planck}} = 2\pi G_0 m_{\text{planck}}^2 / hc = 1$

Gravitational Fine structure unification:  $\{\alpha_g / \alpha_{\text{planck}}\} = \{m_{\text{electron}} / m_{\text{planck}}\}^2$   
 $= \{m_{\text{electron}} / m_c\}^2 \alpha_e^{18}$

Mass Seed =  $M_o = \nu \{E \cdot m_c^2 \cdot m_{\text{planck}}^2 / m_{\text{electron}}^2\} = m_c \nu \{E\} \{\alpha_{\text{planck}} / \alpha_g\}$  for googol space quanta counter  
 $E = 26 \times 65^{61} = 1.006 \dots \times 10^{112}$ .

Charge Seed =  $C_o = \nu \{E \cdot e^2 / \alpha_e\} = \nu \{E \cdot hc / 2\pi k_e\} = \nu \{E \cdot hc G_o / 2\pi\} = \{2e\} \cdot \{M_o / m_c\} \cdot \{E_{ps} \cdot e\}$   
 $= \{2e\} \cdot \{M_o / m_c\} \{e / e^*\}$  for  $E_{ps} = 1/e^*$

Source energy quantum  $E_{ps} = \{\text{Quantized charge in Dirac monopole as dipole}\} \{\text{Number of elementary charged particles}\}$

$E_{ps} = 1/e^* = \{C_o / 2e^2\} \cdot \{m_c / M_o\} = \{C_o / M_o\} \cdot \{m_c / 2e^2\}$   
 $= \{\nu \{E \cdot e^2 / \alpha_e\} / \{m_c \nu \{E\} \{\alpha_{\text{planck}} / \alpha_g\}\} \cdot \{m_c / 2e^2\}$

$E_{ps} = \{1/2e\} \nu \{\alpha_g / \alpha_{\text{planck}} \alpha_e\}$

$E_{ps} = 1/e^* = hf_{ps} = h/f_{ss} = h^2/E_{ss} = m_{ps} c^2 = k_B T_{ps} = 1/2e \nu \alpha_e \{m_{\text{electron}} / m_{\text{planck}}\}$   
 $= \nu \{\alpha_g / \alpha_{\text{planck}} \alpha_e\} / 2e = G_o m_{\text{electron}} / 2e^2$

$1/E_{ps} = e^* = 2R_e c^2 = \nu \{4\alpha_h c e^2 / 2\pi G_o m_e^2\} = 2e \nu \alpha_e [m_{\text{planck}} / m_{\text{electron}}]$   
 $= 2e \nu \{\alpha_e \alpha_{\text{planck}} / \alpha_g\} = \{2e^2 / m_{\text{electron}}\} \sqrt{(k_e / G_o)} = 2e^2 / G_o m_e = e^2 / 2\pi \epsilon_0 m_e$  for  $G_o = 1/k_e = 4\pi \epsilon_0$

for a cosmological unification of fine structures in unitary coupling  
 $E^* \cdot e^* = 1$  in  $[Nm^2/kg^2] = [m^3 s^{-2}/kg] = 1/[Nm^2/C^2] = [C^2 m^{-3} s^2/kg]$  for  $[C^2] = [m^6/s^4]$   
and  $[C] = [m^3/s^2]$ .  $E_{ps} = 1/E_{ss} = 1/e^* = \nu \{\alpha_g / \alpha_e\} / 2e = G_o m_e / 2e^2$

The Charge seed is proportional to the number of particles in Universe as  $\{M_o / m_c\}$  and where the primordial nucleons are all ylemic neutrons of spin  $1/2$  and which so define their radioactive decay products in a charge twin of positively charged protons and negatively charged electrons and with uncharged antineutrinos. The unification between dipolar electropolar Coulomb charge 'e' and monopolar magnetopolar Star-Coulomb charge 'e\*' unifies the Consciousness quantum  $E_{ps} = 1/e^*$  in the nature of dipolar electric charge in the redefinition of the Dirac string and the Dirac magnetic monopole from timespace into spacetime.

In the universe the consciousness quantum manifests as the inverse of the electric charge quantum 'e', so cancelling any dipolar magnetic effects of the monopolar charge e\* in Khaibit. In the universe this monopolar equivalence manifests in its elementary form as the diameter of the electron multiplied by the square of the speed of light c<sup>2</sup>.

The Dark Matter energy so becomes defined in the Universal Consciousness Quantum 'UniPhysCon' → E<sub>ps</sub> = 1/e\* = 1/{2R<sub>e</sub>c<sup>2</sup>} = 1/{Volume [2π<sup>2</sup>R<sub>RMP</sub><sup>3</sup>]}x{Angular Acceleration df/dt} for the dark matter elementary consciousness particle RMP=Restmass-Photon R<sub>RMP</sub> = √[3]{e\*.dt<sub>ss</sub>/d<sub>fps</sub>|<sub>resonance</sub>/2π<sup>2</sup>}

$$R_{RMP} = \sqrt[3]{\{(e^*/2\pi^2)/(9 \times 10^{60})\}} = 1.411884763 \times 10^{-20} \text{ m}^* \text{ and of spin quantum } -1 \text{ and a wavelength}$$

$$\lambda_{RMP} = 2\pi R_{RMP} = 8.8711336 \times 10^{-20} \text{ m}^*$$

The dark matter particle has a mass of m<sub>RMP</sub>=h/cλ<sub>RMP</sub>=2.50500367x10<sup>-23</sup> kg\* and an energy of 2.2545033x10<sup>-6</sup> J\* or 14,034.0 GeV\* or 14.034 TeV\* (13.999 TeV<sub>SI</sub>) as the maximum capacity for the Large Hadron Collider (LHC) at CERN, the international research center for probing the universal energy scales in particle accelerators in Geneva, Switzerland.

**Magneto-Monopolar charge quantum e\*/c<sup>2</sup> = 2R<sub>e</sub> ⇔ super-membrane displacement transformation ⇒ √α.l<sub>planck</sub> = e/c<sup>2</sup> as Electropolar charge quantum .....[Eq.III-1]**

Dirac's quantization condition crystallizes naturally from the relationship between the classical electron radius and its relation to the Compton radius for the oscillation scale for the electron exchanging the nature of the Dirac monopole as a monopolar singularity in timespace and the QBBS with the classical electron scale from the wormhole radius r<sub>ps</sub> to the classical electron radius R<sub>e</sub>=hα/2πcm<sub>electron</sub>=αR<sub>compton</sub> in spacetime.

Dirac's quantization condition derived in its historical context before, states Magnetic monopole q<sub>m</sub> = n.e/2α={n/N}{e/2α} for electropolar charge e quantized in integer n equal to the magnetopolar charge q<sub>m</sub> multiplied by 2α.

Dirac's magnetopolar charge q<sub>m</sub>=g is however defined as:

$$e^* = 2R_e c^2 = 2\alpha R_{compton} c^2 = 1/E_{ps} = \{2e\} \sqrt{\alpha_{planck} \alpha_e / \alpha_g}$$

$$\text{for the result } e^*/2\alpha_e = R_{compton} c^2 = \{e/\alpha_e\} \sqrt{\alpha_{planck} \alpha_e / \alpha_g}$$

$$\text{for quantized } (2e) = e^* \sqrt{\alpha_g / \alpha_{planck} \alpha_e} = e^* \{m_{electron} / m_{planck}\} / \sqrt{\alpha_e}$$

$$= e^* \{m_{electron} / m_c\} \sqrt{\alpha_e^{17}}$$

**Magneto-Monopolar singularity charge quantum e\*√{α<sub>planck</sub>α<sub>g</sub>/α<sub>e</sub>} = 2e as Dipolar Electropolar charge quantum (2e) .....[Eq.III-2]**

The singularity magnetic monopole of the QBBS becomes the point charge elementary electron in Quantum Field Theory (QFT) and Quantum Electro-Dynamics (QED). The classical electron is then enabled to physicalize the Dirac string from timespace in the created spacetime quantizing the previously infinite Dirac string in the inflaton as two boundary wormhole singularities in multiples of the wormhole radius r<sub>ps</sub>=λ<sub>ps</sub>/2π quantized in the classical electron radius in 360R<sub>e</sub>=10<sup>10</sup>λ<sub>ps</sub> as a classical monopolar bound in the spacetime quanta count E.



ROGER PENROSE

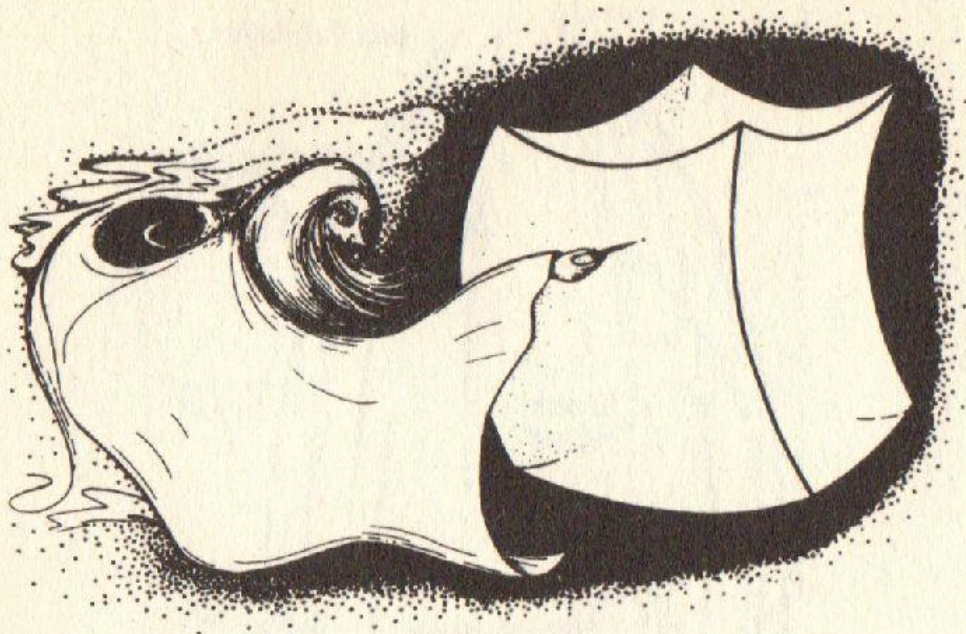

Fig. 1.30. In order to produce a universe resembling the one in which we live, the Creator would have to aim for an absurdly tiny volume of the phase space of possible universes - at most about  $1/10^{10^{123}}$  of the entire volume. (The pin, and the spot aimed for, are not drawn to scale!)

For  $\{R_{RMP}(ss)/R_{RMP}(ps)\}^3 = (f_{ss}/f_{ps})^2 = (f_{ss})^4 = (4\pi^2 r_{ps}/r_{ss}c^2)^2 = \{1/81 \times 10^{120}\} \sim \text{Critical Density/Planck Density}$   
 $\rho_{\text{Planck}}/\rho_{\text{critical}} = \{2\pi c^5/hG_o^2\}/\{3H_o^2/8\pi G_o\} = \{16\pi^2 c^5/3hG_o H_o^2\} = \{1.855079 \times 10^{96}\}/\{3.78782 \times 10^{-27}\} \sim 81 \times 10^{120}$   
 $= 4.897 \times 10^{122}$  in a de Sitter cyclically closed EMR 10D-cosmology for which  $\Omega = \Omega_B + \Omega_{MDM/RMP} + \Omega_{DE} = 1$

$\rho_{\text{Planck}}/\rho_{\text{critical}} = \{2\pi c^5/hG_o^2\}/\{H_o^2/4\pi^2 G_o\} = \{8\pi^3 c^5/hG_o H_o^2\} = \{1.855079 \times 10^{96}\}/\{1.78497 \times 10^{-26}\} \sim 81 \times 10^{120}$   
 $= 1.039 \times 10^{122}$  in an Anti-de Sitter open-closed EMMR 11D-cosmology for which  $\Omega = \Omega_B + \Omega_{MDM/RMP} + \Omega_{DE} = 1$

The Einstein quintessence agency of the RMP is shown to couple in string-membrane duality to both a minimum sourcesink and a maximum sinksources expression in the energy distribution of the multi-dimensional universe. The ratio of the RMP's vibratory wormhole micro eigenstate of high energy to its winding mode anti-wormhole macro self-state then crystallizes the Planck-Density to Critical Density ratio in convolution with the dark energy and Zero-Point-Energy of the multi-dimensional cosmology.

## V: The Higgs-Planck False Vacuum and the Temperature Gradient for the QBBS Cosmology

The temperature evolution of the Instanton can be written as a function of the luminosity  $L(n,T)$  with  $R(n)=R_H/(n+1)$  as the radius of the luminating surface. Luminosity is specified as physical Power  $P$  or total energy  $E$  emitted over a time  $t$ .

For the total energy of Universe as  $E_U = M_o c^2$  for a cycle time  $n=H_o t$  or  $t_{ps} = n_{ps}/H_o$  as initial boundary condition for  $t = n/H_o$  then equates  $H_o M_o c^2/n$  as proportional to  $L(n,T) = (\text{Surface area of the energy emitter})(\text{BBR proportionality constant})(\text{temperature of emitting body})^4$  with proportionality constant  $3/550$  obtained from the 33-tier Maria Code and the Principalities of the Mathimatia.

The second Eps-Expansion-Coefficient in the Expansion Principality now reduces this luminosity by a factor of  $3/550 = 1/183.33\dots$  to indicate the Core-Bulge Ratio for Black Holes, termed a M-Sigma relation in the mapping of the Planck minimum energy Zero-Point Oscillator  $E_p^o = \frac{1}{2}E_p = \frac{1}{2}hf_p = \frac{1}{2}m_p c^2 = \frac{1}{2}k_B T_p$  onto the Instanton parameters of the  $E_{ps}$ -Weyl wormhole.

$$3/550 = 1/\{11.2e^*/60\} = 60 E_{ps}/22 = \frac{1}{2}E_{ps} \cdot \{60/11\} \text{ for } \frac{1}{2}E_{ps} = \{11/60\}\{3/550\} = 33/33,000 = 1/2e^*.$$

The Luminosity function for Universe for a temperature  $T(n=H_o t)$  can be written as:

$$L(n,T) = 6\pi^2 R(n)^2 \cdot \sigma \cdot T^4 = 3H_o M_o \cdot c^2 / 550n \dots\dots\dots \text{ [Eq.IV-1]}$$

$3H_o M_o c^2 / 550n_{ps} = L(n_{ps}, T(n_{ps})) = 6\pi^2 \lambda_{ps}^2 \cdot \sigma \cdot T_{nps}^4 = 2.6711043034 \times 10^{96}$  Watts\* for  $T(n_{ps}) = \sqrt[4]{\{M_o f_{ps}^3 / 1100\pi^2 \sigma\}}$  and where  $\sigma = \text{Stefan's Constant} = 2\pi^5 k^4 / 15h^3 c^2$  in units of  $[J/K^4 m^2 s^{-1}] = [kg/K^4 s^3]$  and as a product of the defined 'master constants'  $k, h, c^2, \pi$  and 'e' from the two self-generating algorithms of the Mathimatia.

The Genesis Boson then became the parametric initialization of creation in the abstract labelling of the Mathimatia:

ENERGY=k.TEMPERATURE=h.FREQUENCY=h/TIME=MASS.c<sup>2</sup> and using the SE<sub>ps</sub>-Master-Constant Set: {4; 6; 7; L<sub>o</sub>=1/[6x10<sup>15</sup>]; c<sup>2</sup>=9x10<sup>16</sup>; 11; h=1/[15x10<sup>32</sup>]; A<sup>2</sup>=14x15<sup>24</sup>; k=1/[15x16<sup>18</sup>]; 26x65<sup>61</sup>} in reverse order and with arbitrary symbols as shown associated with those 'master constants'.

Particularly then: ENERGY =  $hR_{max}/\lambda_{ps} = hR_H/\lambda_{ps}$  with MASS =  $hR_{max}/\lambda_{ps} c^2 = 0.01183463299$  and TEMPERATURE =  $hR_{max}/k\lambda_{ps} = 7.544808988 \cdot 10^{37}$  and FREQUENCY =  $\lambda_{ps}/R_{max} = n_{ps} = 1.59767545 \cdot 10^{48}$  in the Mirror duality  $f_{ps} = 1/f_{ss}$  for  $f_{ps} \cdot f_{ss} = 1$  and time instantaneity  $t_{ps} = f_{ss} = 1/f_{ps}$  as a Maximum/Minimum initial- and boundary condition.

MASS becomes the 'Atomic-Mass-Unit' in 12D-F-Space in using one proto nucleon  $m_c = \text{Alpha}^9 \cdot L_{\text{planck}}$  for every one of the 12 monopolar current loops in the Unified Field of Quantum Relativity UFoQR.

A first E<sub>ps</sub>-Identity-Coefficient in the Expansion Series of the fundamental principles from the SE<sub>ps</sub> algorithm then crystallizes the 'Counter for matter' in Avogadro's Constant for Molarity, subject to mass energy perturbation effects:  $MASS(20/33)/12m_c = N_{\text{avogadro}} = 6.02242143 \times 10^{23} \text{ 1/mol}^*$

The MARIA CODE in the Riemann Analysis specifies the partitioning of the decimal monad around the primary Maria-Number and  $SE_{ps}$ -Constant "11" and specifies the Prime Number Algorithm: +1+11+10+11 as 33-tiered segments, which transform the mechanics of  $SE_{ps}$  into the 64-codex of the DNA/RNA code for its eventual quadrupling as the 256-codex incorporative of dormant intron/intein-codings. Details are in the references, but the MARIA-CODE is based on the distribution of the Maria-Numbers given by:  $M_p + 99 = M_{p+12}$ ;  $n = \frac{1}{2}((264k+1)^{\frac{1}{2}} - 1)$  via  $n^2 + n - 66k = 0$  and the MARIA-INFINITY-MATRIX, semanticised as:

[28]	11LOVE65USE110LOVE164USE209LOVE263USE...(Archetype 2) 21USE66LOVE120USE165LOVE219USE264LOVE...(Archetype 3) 32USE77LOVE131USE176LOVE230USE275LOVE...(Archetype 5) 33LOVE87USE132LOVE186USE231LOVE285USE...(Archetype 6) 44LOVE98USE143LOVE197USE242LOVE296USE...(Archetype 8) 54USE99LOVE153USE198LOVE252USE297LOVE...(Archetype 9) 65USE110LOVE164USE209LOVE263USE308LOVE...(Archetype 2*)	Maria Numbers are those IntegerCounters, which contain all previously counted integers as mod33.  $1+2+3+4+5+6+7+8+9+10+11=66$  Since $66=2 \times 33$ , 11 is $M\#1$ . (for $k=2$ )
------	---	---

Archetypes 2+3+5+6+8+9=33 and Archetypes 1+4+7+0=12 then define the imaginary time-dimensions as the Archetypes not in the Sequence for  $E_{ps} = 1/e^*$  Coefficients used in the application of the seven fundamental principles to define the F-Space.

In particular, the first application of the Coefficient-Relation results in the specification of the Atomic Isotopes and the second application defines the Expansion/Contraction-Principle in the three-fold definition of RESTMASS=..and its transformation into its second (Black Body Transparency) and third (RMP's) as omniversal agency, i.e. Avogadro's Constant:  $N_A = 6.022421431 \times 10^{23} \text{ mol}^{-1}$  as RESTMASS.

**The 33-tier Maria Code from Principalities of the Mathimatia and Eps-Coefficients for Mass Transformation in the Genesis Boson**

For the nth principality, the  $E_{ps}$ -Coefficient-Series and iterative counter k is:

[29]	$[7k-(7-n)].E_{ps}^{k-1}.10/33 = [7(k-1)+n].e^{1-k}.10/33$ Identity-Series( $n=1;k=1,2,3$ ): 10/33; 4/825; 1/55000;.... Expansion-Series: ( $n=2;k=1,2,3$ ): 20/33; 3/550; 2/103125;... Order-Series( $n=3;k=1,2,3$ ): 30/33; 1/165; 17/825000;... Symmetry-Series( $n=4;k=1,2,3$ ): 40/33; 1/150; 3/137500;... Infinity-Series:( $n=5;k=1,2,3$ ): 50/33; 2/275; 19/825000;... Inversion-Series( $n=6;k=1,2,3$ ): 60/33; 13/1650; 1/41250;... Reflection-Series( $n=7;k=1,2,3$ ): 70/33; 7/825; 7/275000;... Relativity-Series( $n=8;k=1,2,3$ ): 80/33; 1/110; 1/37500;... Quantisation-Series( $n=9;k=1,2,3$ ): 90/33; 8/825; 23/825000;... New Identity-Series( $n=10;k=1,2,3$ ): 100/33; 17/1650; 1/34375;...
------	---

For  $k=1$ ; the coefficients have the numerators: 10,20,30,...and denominator 33.

For  $k=2$ ; the coefficients have the numerators: 8,9,10,...and denominator 1650.

For  $k=3$ ; the coefficients have the numerators: 15,16,17,...and denominator 825000.

The  $E_{ps}$ -Coefficient-Series can then be extended to reflect the 7-tiered principality.

The counter  $N=n_{ps}=\lambda_{ps}/R_{max}$  in 'real' time relative to the Quantum Big Bang and emerging from the string epoch and relating to 'imaginary' time relative to this self-same creation in the Cosmogony of the Genesis Boson in Khaibit and the Inflaton-Instanton of the Abba-Baab 11-dimensional super membrane.

This 'virtual' or unreal Quantum Relative Time then manifests as the Hubble-Frequency  $H_o=c/R_H$  in proportionality to the Source Frequency of the  $E_{ps}$ -Gauge Photon  $f_{ps}=c/\lambda_{ps}$  in the expression  $H_o R_{max}=c=\lambda_{ps}\cdot f_{ps}$ .

$N$  then had been the Null time for the initialization of the super membrane modular duality in the De Broglie phase speed initialization, beginning with the oscillation or bounce of the Planck-Length conformably mapped onto time instantaneity as a Now-Cycle-Time  $n_{ps}=H_o t_{ps}=H_o/t_{ss}$  and as the Time Instanton  $t_{ps}=1/f_{ps}=f_{ss}$  and the Inflaton  $R_{max}=R_{Hubble}=c/H_o$  with de Broglie Phase speed  $V_{debroglie} = R_H \cdot f_{ps} = R_H \cdot c/\lambda_{ps} = c/n_{ps}$  as the 'Heartbeat of the Cosmic Mother Black Hole' frequency of the oscillating cosmos in the Cosmology of Abba.

The Hubble frequency  $H(n)$ , so oscillates between two Hubble nodes maximized as frequency as the source frequency  $f_{ps}$  at the Instanton and minimized in the Hubble frequency  $H_o$  at the Inflaton node of the Hubble event horizon as  $H_o = n_{ps}/t_{ps} = \lambda_{ps}f_{ps}/R_H = c/R_H$ .

The third Expansion-Coefficient in the Expansion Principality is  $2/103,125$  and indicates the frequency eigen states for sufficiently 'evolved space-aware' consciousness processors as VPE- $M_o/m_c$  Abba energy collectors.  $(2/103,125)f_{ps}\cdot L_o = 9696969696 = f_i E_i^2$  'self-states' for frequency-mass eigen-states and for a 'optical unification' of Eps.Ess in the form of the Restmass-Photon acting as dark matter gauge ambassador particle on physical consciousness carrying YCM-matter conglomerations or bodies.

The temperature evolution at any cycle time  $n=H_o t$  so is expressed as:

$$T(n) = \sqrt[4]{\{H_o^3 M_o / 1100 \pi^2 \sigma\} \cdot \{(n+1)^2 / n^3\}} \text{ with } L(n, T) = 6 \pi^2 R(n)^2 \cdot \sigma \cdot T^4 = 3 H_o M_o \cdot c^2 / 550 n \dots [\text{Eq.IV-2}]$$

$R(n_{ps}) = n_{ps} R_H / (1+n_{ps}) = \lambda_{ps}$  in the limit of the Instanton with Volumar  $V_3(R) = dV_4/dR = d(\frac{1}{2}\pi^2 R^4)/dR$   
 $V_3(R) = 2\pi^2 R_H^3$  defining a surface area  $dV_H/dR = 6\pi^2 R_H^2$  from the 3-dimensional surface  $V_3$  in the spacetime of Klein's 4-dimensional volume  $V_4(R)$ .

$$L(n, T) = 3 H_o M_o \cdot c^2 / 550 n \text{ and for Temperature } T(n_{ps}) \text{ ----- } T(n_{ps}) = 2.93515511 \times 10^{36} \text{ Kelvin}^*.$$

$T(n_{ps})$  so is the temperature of the Instanton as a function of the baryonic mass seed  $M_o$  and therefore also the temperature of the Dark Energy in terms of the Lambda-Einstein acceleration in proportion to the deceleration parameter  $q_o = \Lambda_o / A_{dB} = \frac{1}{2} \Omega_o = M_o / M_H$ .

In the form and context of quantum gravity however, the temperature of the Instanton was  $T_{ps}=E_{ps}/k=hf_{ps}/k=m_{ps}c^2/k$  for a quantum gravitational minimum Black Hole mass of  $M_{hyper} = r_{ps}c^2/2G_o$ .

The BBR or Planck Black Body Radiator so began its expansion at light speed 'c' with hypermass  $M_{hyper} = \lambda_{ps}c^2/4\pi G_o = 6445.78 \text{ kg}^*$  and about the weight of a pair of mature elephants as the minimum mass for a Schwarzschild Black Hole.

This mass is eleven orders of magnitude greater than the Planck-Mass  $m_{Planck}$   
 Quantum gravity derives from this deviation from the Planck-Mass  $m_{Planck}$  with curvature radius  $L_{Planck}$ .

The rest of the mass seed  $M_o$  so was distributed in the higher dimensional spacetime of Klein as a potential energy defined in the Vortex-Potential-Energy or VPE and in expectation of being 'triggered' as an 'energy of the vacuum' upon the 'filling' of the Klein space in 4 space dimensions by the Möbius 3-dimensional space expanding as the Instanton into the Inflaton.

Within the era of the super membranes, the physical parameters had been defined in the transformation of 5 string classes from the Planck boson to the Weyl boson and prior to the final transformation birthing the Instanton, the Genesis boson had defined the parameter of un-physicalised TEMPERATURE to allow a 'False Vacuum' to manifest the Higgs template in the UFOQR and to correlate the 'Bounce of the Planck length' to a 'Bounce of the Planck time' in the Inflaton-Instanton conformal transition and as the maximum HBPFV. Its minimum is then the deceleration parameter gradient  $q_o = \Lambda_o / A_{dB}$  bounded in the Genesis boson for the parameter initialization.

$$\begin{aligned} t_{\text{Genesis}} &= n_{\text{Genesis}} / H_o = 4.395 \times 10^{-33} \text{ s}^* \text{ for cycle time } n(t_{\text{Genesis}}) = \sqrt[3]{\{H_o^3 M_o / 1100 \pi^2 \sigma\} / \text{TEMPERATURE}^4} \\ &= \sqrt[3]{\{18.200 / 3.2403 \times 10^{151}\}} = \sqrt[3]{\{0.56167 \times 10^{-150}\}} = 8.252 \times 10^{-51} \text{ for } T(n_{\text{Genesis}}) \\ &= \sqrt[4]{\{H_o^3 M_o / 1100 \pi^2 \sigma\} \cdot \{(n_{\text{Genesis}} + 1)^2 / n_{\text{Genesis}}^3\}} = 7.5448 \times 10^{37} \text{ K}^* \text{ in the false Higgs vacuum and} \\ t_{\text{Genesis}} &= 8.252 \times 10^{-51} / H_o = 8.252 \times 10^{-51} / \{f_{ps} \cdot n_{ps}\} = 4.395 \times 10^{-33} \text{ s}^* \text{ from } E(k_B T) / E(hf) \text{ and the Stefan-Boltzmann} \\ &\text{Radiation Law for Black Body EMR with } n_{ps} = H_o / f_{ps} = \lambda_{ps} / R_H = 6.25909 \times 10^{-49} \end{aligned}$$

$$\begin{aligned} t_{dBmin} &= q_o t_{ps} = n_{dBmin} / H_o = n_{ps} \{G_o M_o / c^3\} = 4.672 \times 10^{-33} \text{ s}^* \text{ for cycle time } n(t_{dBmin}) = 8.772 \times 10^{-51} \text{ s}^* \text{ for} \\ T(n_{dBmin}) &= \sqrt[4]{\{H_o^3 M_o / 1100 \pi^2 \sigma\} \cdot \{(n_{dBmin} + 1)^2 / n_{dBmin}^3\}} = 7.206 \times 10^{37} \text{ K}^* \text{ in the false Higgs vacuum from the DE} \\ &\text{gradient instanton bounce for deceleration parameter } q_o = \Lambda_o / A_{dB} = \{G_o M_o / \lambda_{ps}^2\} / \{R_H f_{ps}^2\} = M_o / 2M_H \end{aligned}$$

$$\begin{aligned} 2t_{dBmin} &= \Omega_o t_{ps} = 2n_{dBmin} / H_o = n_{ps} \{2G_o M_o / c^3\} = 9.343 \times 10^{-33} \text{ s}^* \text{ for cycle time } n(t_{dBmin'}) = 1.754 \times 10^{-50} \text{ s}^* \text{ for } T(n_{dBmin'}) \\ &= \sqrt[4]{\{H_o^3 M_o / 1100 \pi^2 \sigma\} \cdot \{(n_{dBmin'} + 1)^2 / n_{dBmin'}^3\}} = 4.285 \times 10^{37} \text{ K}^* \text{ in the false Higgs vacuum from the DE gradient} \\ &\text{instanton bounce for } \Omega_o = M_o / M_H = \{2G_o M_o / \lambda_{ps}^2\} / \{R_H f_{ps}^2\} = 2G_o M_o H_o / c^3 \end{aligned}$$

$$\begin{aligned} t_{HBPFV} &= \{T(n_{ps}) / \text{TEMPERATURE}\} t_{ps} = \{T(n_{ps}) \lambda_{ps} k_B / h R_H\} t_{ps} = T(n_{ps}) n_{ps} k_B t_{ps} / h R_H = n_{HBPFV} / H_o = 1.297 \times 10^{-32} \text{ s}^* \\ &\text{for cycle time } n(t_{HBPFV}) = 2.435 \times 10^{-50} \text{ s}^* \text{ for } T(n_{HBPFV}) = \sqrt[4]{\{H_o^3 M_o / 1100 \pi^2 \sigma\} \cdot \{(n_{HBPFV} + 1)^2 / n_{HBPFV}^3\}} \\ &= 3.351 \times 10^{37} \text{ K}^* \text{ in the false Higgs vacuum} \end{aligned}$$

$$\begin{aligned} t_{dBmax} &= [\nu \alpha] t_{ps} = n_{dBmax} / H_o = 2.847 \times 10^{-32} \text{ s}^* \text{ for cycle time } n(t_{dBmax}) = 5.347 \times 10^{-50} \text{ s}^* \\ &\text{for } T(n_{dBmax}) = \sqrt[4]{\{H_o^3 M_o / 1100 \pi^2 \sigma\} \cdot \{(n_{dBmax} + 1)^2 / n_{dBmax}^3\}} = 1.857 \times 10^{37} \text{ K}^* \text{ in the true Higgs vacuum from the} \\ &\text{Planck-Stoney Inflaton time bounce} \end{aligned}$$

$$\begin{aligned} t_{Weyl} &= t_{ps} = n_{ps} / H_o = \lambda_{ps} / (R_H H_o) = \lambda_{ps} / c = 1 / f_{ps} = 3.333 \times 10^{-31} \text{ s}^* \text{ for cycle time } n_{ps} = 6.2591 \times 10^{-49} \text{ s}^* \\ &\text{for } T(n_{ps}) = \sqrt[4]{\{H_o^3 M_o / 1100 \pi^2 \sigma\} \cdot \{(n_{ps} + 1)^2 / n_{ps}^3\}} = 2.935 \times 10^{36} \text{ K}^* \text{ in the instanton-inflaton } n_{ps} \text{ of the QBBS} \\ &\text{forming the } T_{ps} = E_{ps} / k_b = hf_{ps} / k_b = 1.41671 \times 10^{20} \text{ K}^* \text{ kinetic Temperature gradient of the cosmogenesis.} \end{aligned}$$

The Higgs Vacuum is a true vacuum from the Planck-Stoney instanton-inflaton bounce mirrored in the Weyl-parameters of the QBBS and so encompasses a time interval of  $3.87 \times 10^{-30}$  seconds\* from  $\nu \alpha \cdot t_{ps} = 2.847 \times 10^{-32} \text{ s}^*$  to  $t_{ps} / \nu \alpha = 3.902 \times 10^{-30} \text{ s}^*$ .

The string class epoch from the true Higgs vacuum to the Planck boson are encompassed by the false Higgs vacuum with characteristic boson temperatures below the bound set by the algorithmic temperature definition:

Planck Temperature  $T_{\text{Planck}} = m_{\text{Planck}} \cdot c^2 / k_b = \sqrt{\{hc^5 / 2\pi G_0 k_b^2\}} = 1.075 \times 10^{32} \text{ K}^*$  and the Planck-Length bounce  $T_{\text{Pbopunce}} = T_{\text{Planck}} / \text{Valpha} = 1.258 \times 10^{33} \text{ K}^*$  and below  $T_{\text{Algo}} = E_{\text{Algo}} / k_B = hf_{\text{Algo}} / k_B = hN_{ps} / k_B = h / n_{ps} k_B = hR_H / \lambda_{ps} \cdot k_B = \text{TEMPERATURE} = 7.5448 \times 10^{37} \text{ K}^*$  as the mathematical logical bound for the cosmogenesis in the minimum-maximum protocol described.

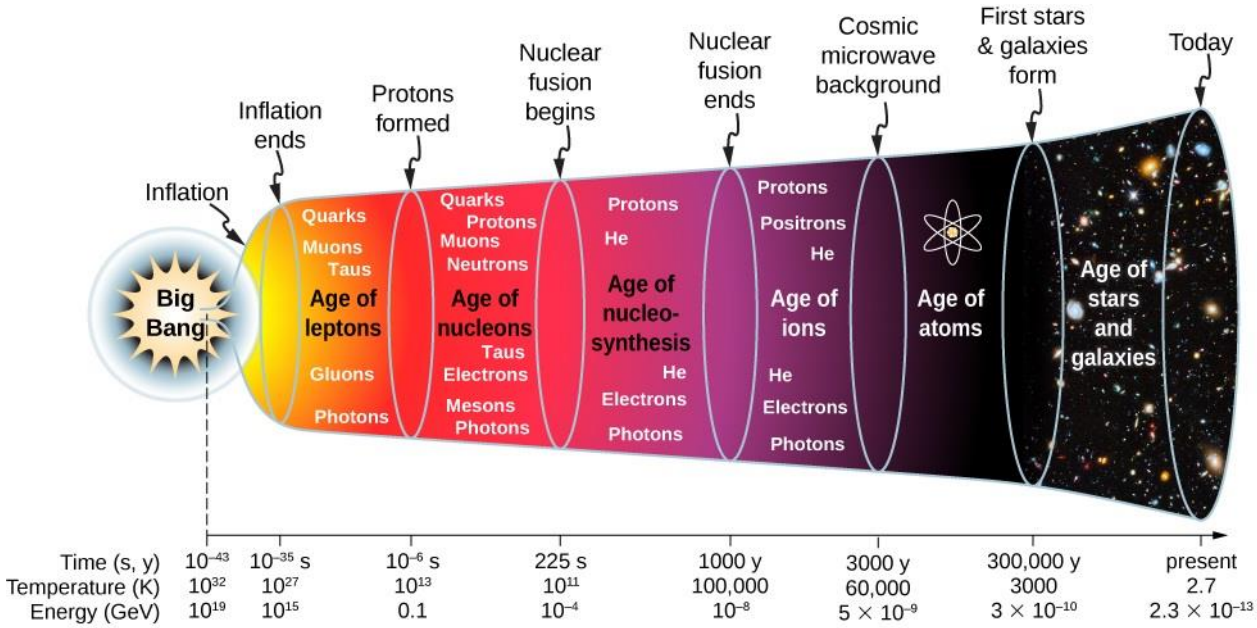

Universe Background  $T(\Delta E) = 2.9352 \times 10^{36} \text{ K}$  decreases to  $T(ps) = k_b T_{ps}$   
 Quantum Self-State  $T(ps) = 1.4167 \times 10^{20} \text{ K}$  Bosonic Unification at  $2 \times 10^{-9} \text{ s}$   
 Instanton Big Bang Inflation

$n = 3.333 \times 10^{-31}$   
 $t_{ps}^2 / t_{ALGO} = t_{ps} / H_0 = 1.775 \times 10^{-13}$   
 $n = H_0 t_{ps}^2 / n_{ps} = ct_{ps}^2 / \lambda_{ps} = t_{ps} = 1 / f_{ps} = f_{ss}$   
 mass eigen frequency  
 Image of 1<sup>st</sup> Logos Algorithmic Mathimatia definition

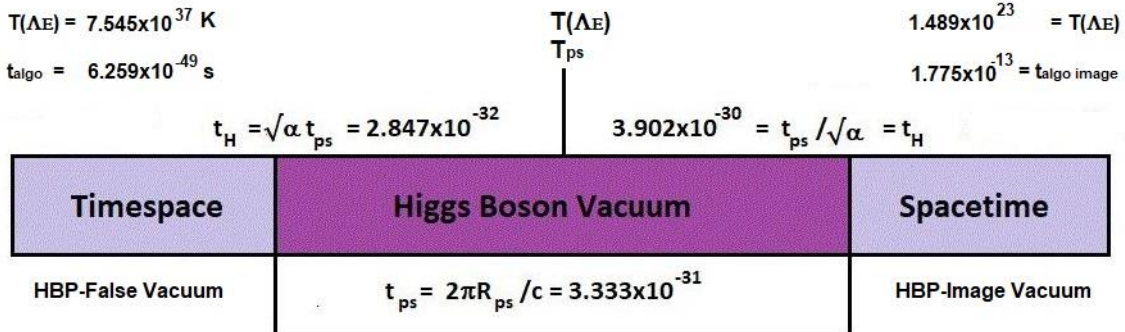

The natural exponent  $e$  is defined in the inversion of scale parameter  $1/a = \{1+1/n\}$

$e = \lim_{n \rightarrow \infty} \{1+1/n\}^n$  for  $e = \{1+1/n\}$  for  $x=1=hf/kT$  in Planck's Radiation Law for a Black Body

$e-1=1/n$  for  $n=1/[e-1]=1/Y^n = X^n$

$n' = \ln(e-1)/\ln Y = 1.12492010...$   
for a time coordinate 0.0075 or about 126.58 Million years ago

$$e^{\frac{hf}{kT}} = 1 + \frac{1}{n} \text{ for } n(f, T) = \frac{1}{e^{\frac{hf}{kT}} - 1} \quad (\text{Eq. \#26})$$

Now consider the universe as a Black Body or a particle in a quantum box, the box being of course the quantumspace boundary  $r_{\max}$ , itself bounded by omnispaces as the 11-dimensional supermembrane, with 28 7-spheres relating to 26 bosonic dimensions via the quantization of Prime numbers as encountered.

The U-Field is quantized into 12-intersecting unified current loops and the extent is  $4\lambda_{ps} = 4 \times 10^{-22} \text{ m}^*$ .

We so consider the frequency interval  $2\lambda_{ps}N$

and the "volume" of the black box is quantized

$$N = L/2\lambda = Lf/2c \text{ with } dN = Ldf/2c \text{ for } N^2 dN = (L^3 f^2 / 8c^3) df$$

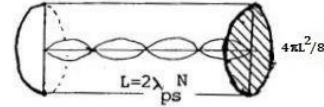

Surface Area of a sphere as octant of a cubic box volume  $L^3$

Now the "volume" of the box is  $L^3/8$  and our dimensionless volume becomes the Number of FREQUENCY STATES for a black body with frequencies in the interval  $df$ .

Since the temperature for a given frequency interval determines the distribution of the radiation spectrum, we determine the spectral distribution  $dE/df$  via

As a photon has two quantum polarization spin momenta, the Frequency States are doubled.

$$\text{Frequency States } 2 \times 4\pi N^2 dN = 8\pi L^3 f^2 / 8c^3 df$$

$$\text{The number of photons in } df: \frac{8\pi f^2(V)}{c^3} \times \frac{1}{e^{\frac{hf}{kT}} - 1} df = dP$$

$$dE = hf dP = \frac{8\pi h \cdot V}{c^3} \cdot \frac{f^3}{e^{\frac{hf}{kT}} - 1} df$$

$$\text{and the total energy in the cubic black box is: } E = \int_0^\infty dE = \frac{8\pi hV}{c^3} \int_0^\infty \frac{f^3}{e^{\frac{hf}{kT}} - 1} df \quad (\text{Eq. \#27})$$

Since we evaluate for a given T, we set  $u=hf/kT$  and  $du=(h/kT)df$

and we need to evaluate the proportionality constant via the integral  $\int_0^\infty \frac{u^3}{e^u - 1} du$

This can be written as:  $\int_0^\infty \frac{u^3}{e^u - 1} du = \Gamma(3+1) \zeta(3+1)$

The GAMMA function  $\Gamma(x)$  satisfies the form:  $x = \frac{\Gamma(x+1)}{\Gamma(x)}$  as analogue to our  $\frac{n+1}{n} = 1 + \frac{1}{n}$

generally  $\Gamma(x) = \int_0^\infty t^{x-1} e^{-t} dt$  and for  $n$  a positive integer then  $\Gamma(n+1) = n! \cdot \Gamma(1) = n!$

The ZETA function of Riemann is defined as  $\zeta(z) = \sum_{n=1}^\infty 1/n^z$

We require  $\Gamma(4) \cdot \zeta(4) = 3! \cdot \sum_{n=1}^\infty 1/n^4 = 3! \cdot (1/1^4 + 1/2^4 + 1/3^4 + \dots + 1/n^4 \dots)$

$$f(x) = x^4 \text{ with period } 2\pi, \text{ then } a_n = \frac{1}{\pi} \int_0^{2\pi} x^4 \cdot \cos(nx) dx = \frac{1}{\pi} \left( \frac{4x^3}{n^2} - \frac{24x}{n^4} \right) \Big|_0^{2\pi} = \frac{32\pi^2}{n^2} - \frac{48}{n^4}$$

$$\text{for } n=0, a_0 = \frac{1}{\pi} \int_0^{2\pi} x^4 dx = \frac{32\pi^4}{5}$$

$$f(x) = x^4 = \frac{1}{2} a_0 + \sum_{n=1}^\infty a_n \cdot \cos(nx) = \frac{16\pi^4}{5} + \sum_{n=1}^\infty \left( \frac{32\pi^2}{n^2} - \frac{48}{n^4} \right) \cdot \cos(nx)$$

$$f(0) = f(2\pi) = \frac{1}{2}(0 + 16\pi^4) = 8\pi^4 \text{ (Dirichlet Condition) and we use the result } \sum_{n=1}^\infty \frac{1}{n^2} = \frac{\pi^2}{6}$$

and obtained similarly in setting  $f(x) = x^2$ .

$$\text{Then for } f(0), \text{ we have } \frac{24\pi^4}{5} = 32\pi^2 \cdot \frac{\pi^2}{6} - 48 \sum_{n=1}^\infty \frac{1}{n^4} \text{ and } \sum_{n=1}^\infty \frac{1}{n^4} = \frac{\pi^4}{90}$$

$$\text{Total Energy } E = \frac{3! \pi^4 V \cdot 8\pi k^4 T^4}{90h^3 c^3} = \frac{4V}{c} \left[ \frac{2\pi^5 k^4}{15h^3 c^2} \right] T^4 = \frac{4\sigma V T^4}{c}$$

Stefan-Boltzmann  
Constant  $\sigma$

**Radiation Energy** =  $\frac{4\sigma T^4}{m_c Y^n c^3}$  for Radiation Pressure = Matter Pressure  
Early Universe Later Universe

$$T_{\text{Equilibrium}} = \sqrt[4]{18.20 \frac{(n+1)^2}{n^3}} = \sqrt[4]{\frac{m_c Y^n c^3}{4\sigma}} \quad \frac{n^3 Y^n}{n^2 + 2n + 1} = \frac{72.80\sigma}{m_c c^3} = (1.65107 \times 10^4) (K^4/V)^*$$

A Cosmic Background temperature of 18.35 Kelvin\* for a cycle coordinate of 0.056391 and as 0.056391(16.88 Gy) or 951.2 Million Years after the Instanton to begin the birthing of galaxies

<b>Khaibit Shadow-Mirror</b> <b>Universe de Abba</b> Remains fully dark energized until $n = -\frac{1}{2}$ from Hubble Inflaton node $n = -1$	<b>Riemann Universe</b> <b>Universe de Baab</b> Remains fully light energized from $n = +\frac{1}{2}$ from Hubble Anti-Inflaton node $n = +1$
--	--

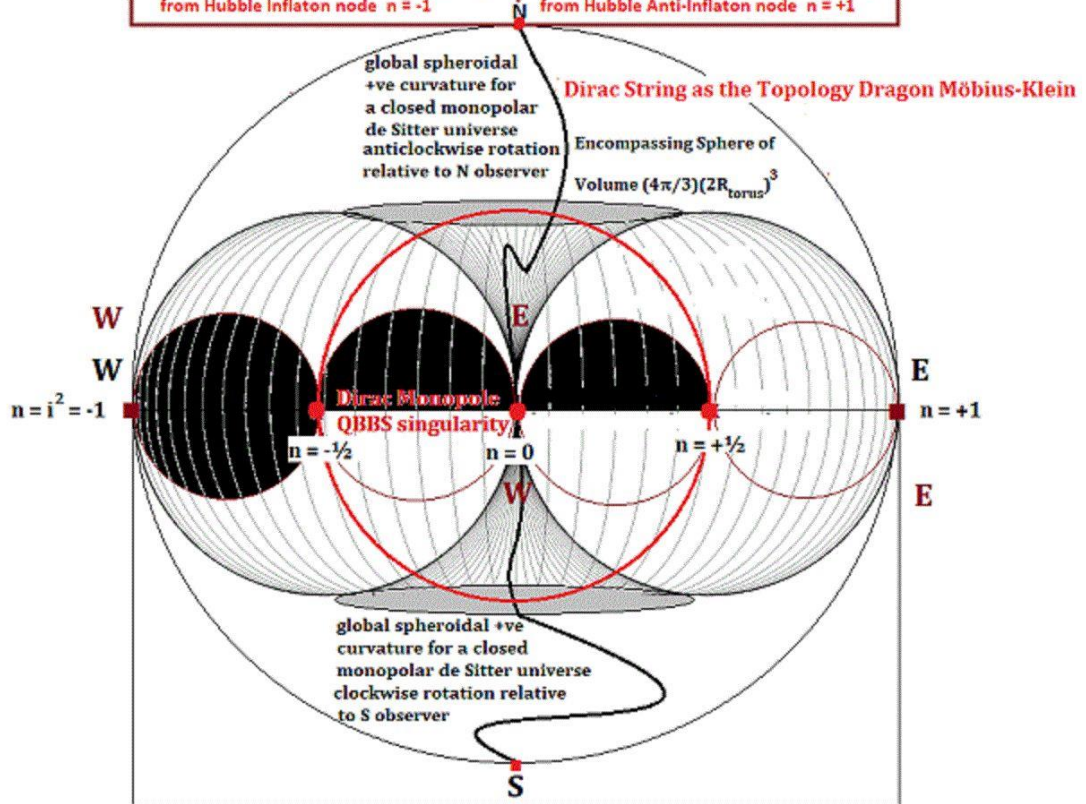

Radius $R_{\text{torus}}$	Radius $R_{\text{torus}}$	Radius $R_{\text{sphere}} = 2 R_{\text{torus}}$
---------------------------	---------------------------	---

$t_{\text{ALGO}} = n_{\text{ps}} = \lambda_{\text{ps}}/R_H = 6.259 \times 10^{-49}$ $t_{\text{OPL}} = 2\pi e/c^3 = \sqrt{\alpha} t_{\text{PL}} = 3.739 \times 10^{-44}$ $t_{\text{PL}} = 2\pi R_{\text{PL}}/c = 4.377 \times 10^{-43}$ $t_{\text{MO}} = 2\pi R_{\text{MO}}/c = 5.124 \times 10^{-42}$ $t_{\text{MO}} = 2\pi R_{\text{MO}}/c = 1.537 \times 10^{-40}$ $t_{\text{XL}} = 2\pi R_{\text{XL}}/c = 2.202 \times 10^{-39}$ $t_{\text{EC}} = 2\pi R_{\text{EC}}/c = 6.618 \times 10^{-34}$ $t_H = G_o M_o t_{\text{ps}}/R_H c^2 = 4.672 \times 10^{-33}$	$\uparrow$	$1.775 \times 10^{-13} = t_{\text{ps}}^2/t_{\text{ALGO}} = t_{\text{ALGO}}$ $2.972 \times 10^{-18} = t_{\text{ps}}^2/t_{\text{OPL}} = t_{\text{OPL}}$ $2.539 \times 10^{-19} = t_{\text{ps}}^2/t_{\text{PL}} = t_{\text{PL}}$ $2.169 \times 10^{-20} = h/E = t_{\text{MO}}$ $7.229 \times 10^{-22} = t_{\text{ps}}^2/t_{\text{MO}} = t_{\text{MO}} \left[ \begin{smallmatrix} 30\text{ec} \\ \text{ec} \\ \text{min} \end{smallmatrix} \right]$ $5.046 \times 10^{-23} = t_{\text{ps}}^2/t_{\text{XL}} = t_{\text{XL}}$ $1.679 \times 10^{-28} = t_{\text{ps}}^2/t_{\text{EC}} = t_{\text{EC}}$ $3.902 \times 10^{-30} = t_{\text{ps}}/\sqrt{\alpha} = t_H$ $2.378 \times 10^{-29} = R_H c^2 t_{\text{ps}}/G_o M_o = t_H$	$\downarrow$
---	------------	---	--------------

Timespace	Higgs Boson Vacuum	Spacetime
	$t_{\text{ps}} = 2\pi R_{\text{ps}}/c = 3.333 \times 10^{-31}$	



String-Membrane Bosc	Classification	Realm	Time Formula	Manifest Time	Energy hf=h/t J*/GeV*	Displacement Scale
Algo-Boson	Time=Frequency $t_{ps}=1/f_{ps}=f_{cs}=1/t_{ss}$	Abstract Definiton	$n_{ps}=\lambda_{ps}/R_H$ $n_{ps}=H_0 t_{ps}=ct_{ps}/R_H$	6.256x10 <sup>-49</sup>	1.066x10 <sup>15</sup> 6.635x10 <sup>24</sup>	$R_{ALGO}=2\pi L_{ALGO}=1.878x10^{40}$ $L_{ALGO}=r_{ALGO}=2.989x10^{41}$
Planck-Oscillation Bosc	Zero-Point Quantum Fluctuation	Timespace	$t_{OPL}=\sqrt{\alpha} t_{ps}$ $\sqrt{\alpha} R_{pl}/c=e/c^2$	3.739x10 <sup>-44</sup>	1.783x10 <sup>10</sup> 1.110x10 <sup>20</sup>	$R_{OPL}=2\pi L_{OPL}=1.122x10^{35}$ $L_{OPL}=r_{OPL}=\sqrt{\alpha} L_{planck}=1.786x10^{36}$
Planck-Boson	string class I Planck open	Timespace	$t_{pl}=2\pi R_{pl}/c$ $R_{pl}=\sqrt{\{hG_{pl}/2\pi c^3\}}$	4.377x10 <sup>-43</sup>	1.523x10 <sup>9</sup> 9.484x10 <sup>18</sup>	$R_{pl}=2\pi L_{planck}=1.313x10^{34}$ $L_{planck}=r_{pl}=2.090x10^{35}$
Monopole Bosc	Maximum 30[ec] for gravity GM↔2G <sub>pl</sub> M	Timespace	$t_{MO}=h/E_{MO}$	5.124x10 <sup>-42</sup>	1.301x10 <sup>8</sup> 8.100x10 <sup>26</sup>	$R_{MO}=2\pi L_{MO}=1.537x10^{33}$ $L_{MO}=r_{MO}=2.446x10^{34}$
Monopole Bosc	string class heterotic HO(32) closed	Timespace	$t_{MO}=2\pi R_{MO}/c$	1.537x10 <sup>-40</sup>	4.337x10 <sup>6</sup> 2.700x10 <sup>25</sup>	$R_{MO}=2\pi L_{MO}=4.611x10^{32}$ $L_{MO}=r_{MO}=7.339x10^{33}$
XL-Boson	string class IIB closed	Timespace	$t_{xl}=2\pi R_{xl}/c$	2.202x10 <sup>-39</sup>	3.028x10 <sup>5</sup> 1.885x10 <sup>15</sup>	$R_{xl}=2\pi L_{xl}=6.606x10^{31}$ $L_{xl}=r_{xl}=1.051x10^{31}$
Ecosmic-Boson	string class IIA closed	Timespace	$t_{ec}=2\pi R_{ec}/c$	6.618x10 <sup>-34</sup>	0.833 5.189x10 <sup>9</sup>	$R_{ec}=2\pi L_{ec}=1.985x10^{25}$ $L_{ec}=r_{ec}=3.159x10^{26}$
False Vacuum Higgs-Boson Upper	Higgs string	Timespace	$G_0 M_0 t_{ps}/R_H c^2$	4.672x10 <sup>-33</sup>	0.143 8.885x10 <sup>8</sup>	$R_{Higgs}=2\pi L_{Higgs}=1.402x10^{24}$ $L_{Higgs}=r_{Higgs}=2.231x10^{25}$
False Vacuum Higgs-Boson Lower	Timespace OPL-Image	Timespace	$\sqrt{\alpha} t_{ps}$	2.847x10 <sup>-32</sup>	0.0234 1.458x10 <sup>8</sup>	$R_{Higgs}=2\pi L_{Higgs}=8.541x10^{24}$ $L_{Higgs}=r_{Higgs}=1.359x10^{24}$
Weyl-Boson-QBBS radius	string class heterotic HE(64) closed	QBBS Spacetime	$t_{ps}=r_{ps}/c$	5.305x10 <sup>-32</sup>	0.0126 7.823x10 <sup>7</sup>	$r_{ps}=\lambda_{ps}/2\pi=1.592x10^{23}$
Weyl-Boson-QBBS wavelength	Closed string class heterotic HE(64) closed	QBBS Spacetime	$t_{ps}=2\pi r_{ps}/c$	3.333x10 <sup>-31</sup>	2x10 <sup>-3</sup> 1.245x10 <sup>7</sup>	$\lambda_{ps}=10^{22}$
Weyl-Boson-QBBS modular wavelength	string class heterotic HE(64) closed	QBBS Spacetime	$t_{ps}=2\pi \lambda_{ps}/c$	2.094x10 <sup>-30</sup>	3.184x10 <sup>-4</sup> 1.982x10 <sup>6</sup>	$2\pi \lambda_{ps}=6.283x10^{22}$
False Vacuum Higgs- Bosc Lower	Spacetime OPL-Image	Spacetime	$t_{ps}/\sqrt{\alpha}$	3.902x10 <sup>-30</sup>	1.709x10 <sup>-4</sup> 1.064x10 <sup>6</sup>	$R_{Higgs}=2\pi L_{Higgs}=1.171x10^{21}$ $L_{Higgs}=r_{Higgs}=1.864x10^{22}$
False Vacuum Higgs- Bosc Upper	Higgs string	Spacetime	$R_H c^2 t_{ps}/G_0 M_0$	2.378x10 <sup>-29</sup>	2.803x10 <sup>-5</sup> 1.746x10 <sup>5</sup>	$R_{Higgs}=2\pi L_{Higgs}=7.134x10^{21}$ $L_{Higgs}=r_{Higgs}=1.135x10^{21}$
Ecosmic Bosc	Cosmic Ray Image Knee	Spacetime	$t_{ps}^2/t_{ec}$	1.679x10 <sup>-28</sup>	3.971x10 <sup>-6</sup> 2.472x10 <sup>4</sup>	$R_{ec}=2\pi L_{ec}=5.037x10^{20}$ $L_{ec}=r_{ec}=8.017x10^{21}$
XL-Boson	Cosmic Ray Image Ankle	Spacetime	$t_{ps}^2/t_{xl}$	5.046x10 <sup>-23</sup>	1.321x10 <sup>-11</sup> 8.225x10 <sup>-2</sup>	$R_{xl}=2\pi L_{xl}=1.514x10^{19}$ $L_{xl}=r_{xl}=2.410x10^{20}$
Monopole Bosc	Cosmic Ray Image Toe	Spacetime	$t_{ps}^2/t_{MO}$	7.229x10 <sup>-22</sup>	9.222x10 <sup>-13</sup> 5.742x10 <sup>-3</sup>	$R_{MO}=2\pi L_{MO}=2.169x10^{13}$ $L_{MO}=r_{MO}=3.451x10^{14}$ Universe the size of the Compton quantum scale $R_{compton}=R_0/\alpha=h/2\pi mc$
Monopole Bosc	Minimum 30[ec] for quantum gravity	Spacetime	$t_{MO}=h/E_{MO}$	2.169x10 <sup>-20</sup>	3.074x10 <sup>-14</sup> 1.914x10 <sup>-4</sup>	$R_{MO}=2\pi L_{MO}=6.507x10^{12}$ $L_{MO}=r_{MO}=1.036x10^{12}$ Universe the size of the wave matter de Broglie quantum scale $\lambda_{qb}=h/mc$
Planck Bosc	Planck boson Image	Spacetime	$t_{ps}^2/t_{pl}$	2.539x10 <sup>-19</sup>	2.626x10 <sup>-15</sup> 1.635x10 <sup>-5</sup>	$R_{pl}=2\pi L_{pl}=7.617x10^{11}$ $L_{pl}=r_{pl}=1.212x10^{11}$ Universe the size of the Bohr atom scale $\lambda_{bohr}=R_0/\alpha^2$
Planck-Oscillation Bosc	Planck bounce Image	Spacetime	$t_{ps}^2/t_{OPL}$	2.972x10 <sup>-18</sup>	2.243x10 <sup>-16</sup> 1.396x10 <sup>-6</sup>	$R_{OPL}=2\pi L_{OPL}=8.916x10^{10}$ $L_{OPL}=r_{OPL}=1.419x10^{10}$ Universe the size of an atom
Algo Bosc	Genesis boson Image	Spacetime	$t_{ps}^2/t_{ALGO}$	1.775x10 <sup>-13</sup>	3.756x10 <sup>-21</sup> 2.338x10 <sup>-11</sup>	$R_{ALGO}=2\pi L_{ALGO}=5.32558484x10^5$ $L_{ALGO}=r_{ALGO}=8.47593x10^6$ Universe the size of smallest life bio-organisms; cellular complex

This manifests as a 'false vacuum' and as a temperature gradient, as a causation of the Big Bang Instanton-Inflaton emergence on physical grounds.

The metaphysical ground is the symmetry breaking from the source parity violation described in the birth and necessity of the Graviton to resymmetrize the UFor and as a consequence of Abba's quest to find Baab as Universe without and within as Sophia Earth and the forms of Adam and Eve reborn from their archetypically energized nature as physicalized body forms manifesting the Life of Universe, Multiverse and Omniverse.

$$T(n)^4 = H_0 M_0 c^2 / (2\pi^2 \sigma_{RH}^2 [550n^3 / [n+1]^2]) \text{ for } T(n)^4 = \{[n+1]^2 / n^3\} H_0 M_0 c^2 / (2\pi^2 \sigma_{RH}^2 [550]) = 18.1995 \{[n+1]^2 / n^3\} (K^4/V)^*$$

TEMPERATURE/ $T(n_{ps}) = 7.544808988... \times 10^{37} / 2.93515511 \times 10^{36} = 25.705 = 1/0.03890... T(n_{ps}) = 2.935 \times 10^{36} K^*$   
of the singularity is 0.0389 or 3.89% of the pre-singularity within the Inflaton.

So, the POTENTIAL 'algorithmic' Temperature manifests as 3.89% in the 'Vacuum-VPE/ZPE phase transitioned' KINETIC Temperature' which doubles in the Virial Theorem to 7.78% as  $2KE + PE = 0$  and maps or transfers the 'Higgs Bosonic-Planck False Vacuum' or HBPFV in projecting the timespace of the algorithmic parameter space of the Mathimatia onto the herewith created spacetime of the Instanton-Inflaton period of the QBBS within the 'Higgs Bosonic Planck-Weyl True Vacuum' or HBPWTV.

Applying the actual VPE/ZPE as a function of the physicalized EMR at the Instanton to this temperature gradient then manifests and projects this temperature gradient with a one percent perturbation centered on the Instanton-Inflaton of the Weylian Eps.Ess supermembrane QBBS.

For the %-interval  $\{(0.038903-0.039313) - |0.0583545| - (0.076995-0.077806)\}$  for a delta of  $\Delta = 1.01054 = 1/0.98957$ :

$$\{[(5.51143-5.56951) \times 10^{18}] - [(1.09080-1.10229) \times 10^{19}] - T_{ps} = T_{weyl} = 1.41671 \times 10^{20} \\ T_{ps} = T_{weyl} = 1.41671 \times 10^{20} - [(1.82082-1.84000) \times 10^{21}] - [(3.60369-3.64165) \times 10^{21}]\} K^*$$

$\rho_{VPE} / \rho_{EMR} = \{4\pi E_{ps} / \lambda_{ps}^3\} / \{8\pi^5 \{k_B T\}^4 / 15h^3 c^3\} = 15 \{E_{ps} / k_B T\}^4 / 2\pi^4 = 0.07699486... \{E_{ps} / k_B T\}^4$  indicating the proportionality  $E_{VPE} / E_{EMR} \propto \{T_{ps} / T_{EMR}\}^4$  in proportionality constant  $1/12.98 T_{ps} / T_{potential}$  at the Instanton from the Inflaton as an original form of the virial theorem, stating the Potential Energy of the de Broglie wave matter Inflaton  $A_{dB} = R_{Hubble} f_{ps}^2$  to be twice the Kinetic Energy of the 'cosmological constant' in the Einstein quintessence  $\Lambda_o = G_o M_o / \lambda_{ps}^2$  Weyl Instanton, then manifesting as the  $\Lambda_o / A_{dB} = q_o = \frac{1}{2} \Omega_o = M_o / 2M_{Hubble} = R_{Sarkar} / 2R_{Hubble}$  Schwarzschild-Strominger mass cosmic evolution.

This then extrapolates the Big Bang singularity backwards in Time to harmonize the equations and to establish the 'driving force of the vacuum' as the DE from Khaibit and in association with a potential scalar Higgs Temperature Field.

All the further evolvement of the universe so becomes primarily a function of Temperature and not of mass.

$n=H_0 t=c t/R_H$ Redshift $z$	$M_{\text{Hawking}} \text{ kg}^*$	$T_{\text{ylem}} \text{ K}^*$	$T_{\text{CBBR}} \text{ K}^*$	$R_{\text{Hawking}} = R_{\text{curv}} \text{ m}^*$ micro BH	$R_{\text{ylem}} \text{ m}^*$	$M_{\text{curv}} \text{ kg}^*$ $M_{\text{curv}}/R_{\text{curv}} \text{ kg}^*/\text{m}^*$ macro BH
$n_p=1.132711$ $t_p=19.12 \text{ Gy}$ $z=0.2505/1.08$	$3.53 \times 10^{25}$	0.0259	2.7470	$8.21 \times 10^{-4}$	0.0871	$3.32 \times 10^{23}$
$n=1$ $t=16.88 \text{ Gy}$ $z=0.2910/1.84$	$3.64 \times 10^{25}$	0.0251	2.921	$7.72 \times 10^{-4}$	0.0899	$3.13 \times 10^{23}$
$n=0.867289$ $t=14.64 \text{ Gy}$ $z=0.3432$	$3.77 \times 10^{25}$	0.0242	3.140	$7.19 \times 10^{-4}$	0.0933	$2.91 \times 10^{23}$
$n_{DE}=1/2$ $t_{DE}=8.44 \text{ Gy}$ $z=0.6124$	$4.39 \times 10^{25}$	0.0208	4.254	$5.30 \times 10^{-4}$	0.1085	$2.15 \times 10^{23}$
$n_{\text{Sarkar}}=0.014015$ $t_{\text{Sarkar}}=236.5 \text{ My}$ $z=7.477$	$1.52 \times 10^{26}$	$6.00 \times 10^{-3}$	51.0613	$4.42 \times 10^{-5}$	0.3757	$1.79 \times 10^{22}$ $M_0=1.81 \times 10^{51}$ $R_{\text{Sarkar}}=4.48 \times 10^{24}$
$n_{\text{macBH}}=3.9 \times 10^{-4}$ $t_{\text{macBH}}=6.64 \text{ My}$ $z=49.421$	$4.02 \times 10^{26}$	$2.27 \times 10^{-3}$	358.05	$6.30 \times 10^{-6}$	0.9942	$2.55 \times 10^{21}$ $M_{\text{max}}=2.54 \times 10^{49}$ $R_{\text{max}}=6.28 \times 10^{22}$
$n_{\lambda_{ss}}=6.26 \times 10^{-5}$ $t_{\lambda_{ss}}=1.06 \text{ My}$ $z=125.40$	$1.15 \times 10^{27}$	$7.92 \times 10^{-4}$	2935.13	$7.69 \times 10^{-7}$	2.8496	$3.11 \times 10^{20}$
$n=H_0 c=c^2/R_H$ $t=c \text{ s}^* = 9.51 \text{ y}$ $z=42,132.1$	$9.04 \times 10^{28}$	$1.01 \times 10^{-5}$	$1.79 \times 10^7$	$1.26 \times 10^{-10}$	223.46	$5.10 \times 10^{16}$ tachyon QBBS Lightpath Image
$n_{EW}=1.34 \times 10^{-20}$ $t_{EW}=0.007 \text{ s}^*$ $z=8.6382 \times 10^9$	$8.87 \times 10^{32}$	$1.03 \times 10^{-9}$	$1.66 \times 10^{15}$	$1.36 \times 10^{-18}$	$2.14 \times 10^6$	$5.51 \times 10^8$ electroweak HB- RMP unification
$n_{BU}=3.56 \times 10^{-27}$ $t_{BU}=2 \times 10^{-9} \text{ s}^*$ $z=1.676 \times 10^{12}$	$2.54 \times 10^{35}$	$3.60 \times 10^{-12}$	$1.42 \times 10^{20}$	$1.59 \times 10^{-23}$	$6.25 \times 10^8$	6445.77 bosonic unification of temperature
$n_{ps}=\lambda_{ps}/R_H$ $t_{ps}=f_{ss}=1/f_{ps}$ $z=1.26 \times 10^{24}$	$3.65 \times 10^{43}$	$2.50 \times 10^{-20}$	$2.94 \times 10^{36}$	$7.68 \times 10^{-40}$	$9.01 \times 10^{16}$	$3.11 \times 10^{13}$ QBBS instanton-inflaton
HBV-Inversion Inflaton Image	$2.54 \times 10^{49}$	$2.04 \times 10^{-26}$	$2.04 \times 10^{-26}$	$1.11 \times 10^{23}$	$3.00 \times 10^{11}$	$M_{\text{max}}=2.54 \times 10^{49}$ $R_{\text{max}}=6.28 \times 10^{22}$
HBV-Inversion Inflaton Image	$1.81 \times 10^{51}$	$1.42 \times 10^{-28}$	$1.42 \times 10^{-28}$	$1.59 \times 10^{25}$	$3.60 \times 10^{12}$	$M_0=1.81 \times 10^{51}$ $R_{\text{Sarkar}}=4.48 \times 10^{24}$
HBV-Inversion Inflaton Image	$6.47 \times 10^{52}$	$1.42 \times 10^{-29}$	$1.42 \times 10^{-29}$	$R_H=1.59 \times 10^{26}$	$1.14 \times 10^{13}$	$M_H=6.47 \times 10^{52}$ $R_H=1.60 \times 10^{26}$

The next big phase transition is the calibration of the BOSONIC UNIFICATION, namely the 'singularity' temperature  $T_{ps}=1.41 \times 10^{20}$  K with the Luminosity function. This occurs at a normal time of 1.9 nanoseconds into the cosmology.

$T(n_{ps})$  reduces to  $T_{ps} = 1.4167 \times 10^{20}$  K\* for  $L(n,T) = 6\pi^2 R(n)^2 \cdot \sigma \cdot T^4 = 3H_0 M_0 \cdot c^2 / 550n$  and  $T_{ps} = E_{ps} / k_B$  for  $n_{BU}^3 / (1+n_{BU})^2 = H_0^3 M_0 / (1100\pi^2 \sigma \cdot T_{ps}^4)$  and for  $n_{BU} = \sqrt[3]{\{4.511 \times 10^{-80}\}} = 3.562 \times 10^{-27}$  for  $t_{BU} = n_{BU} / H_0 = 1.90 \times 10^{-9}$  s\* or 1.9 nanoseconds\*.

It is then that the universe as a unity has this temperature and so allows BOSONIC differentiation between particles.

The individuated Bosons of the mass had been born then and not before, as the entire universe was a bosonic macro-quantized superstring or super-heated Bose-Einstein Condensate or SH-BEC until the bosonic unification nexus was reached by the expansion of Universe from the lower dimensional Instanton of Möbius into the higher dimensional Inflaton of Klein.

The size of the universe at that time was being 1.14 meters across by  $R(n_{BU}) = R_H \{n_{BU} / (1+n_{BU})\} = 0.57$  m\*.

Next came the electroweak symmetry breaking at 1/140 seconds and at a temperature of so  $1.7 \times 10^{15}$  Kelvin\*

The Physical Quantum of Consciousness as Space-Awareness (df/dt) maximized and minimized in the string coupling constants  $f_{ps}^2$  and  $f_{ss}^2$  respectively, so can be defined as:

$$e^* = 2R_e c^2 = (\text{Classical Electron Diameter}) \times (\text{lightspeed})^2 = \text{VolumexAngular Acceleration}$$

As the time differential operator on frequency is independent on radial displacement in df/dt as the square of frequency or the square of inverse time; we can now also define the parameter of:

Spacial Awareness = df/dt = AlphaOmega =  $\alpha\omega = a\omega = \text{Angular Acceleration Quantum}$ .

The Spacial Awareness 'aw' then operates upon any volumar in the root-reduced F-Space (12D being a 9-dimensional brane volumar of superstring dimensions to which is coupled a 3-dimensional temporal time-connector volumar in 12=9+3 F-Space, 11=9+2 M-Space and 10=9+1 C-Space) and as the 3-D volume of the observed spacial component of the 'Euclidean flatness of the Minkowski spacetime metric.

The implications of those definitions for the physical universe and its cosmology are far reaching indeed. As the expanding universe increases in its 3-dimensional volume, its 'spacial consciousness' is also increasing in the 'activation' of additional spacetime quanta.

Each of these spacetime quanta describes the inherent Zero-Point-Energy (ZPE) as defined in the 3D-volumar of the Eps sourcesink superstring energy quantum then coupled to its characteristic 'star coulombic' 'physical consciousness'.

The ZPE per unit volumar is:  $ZPE_{\text{quantum}} = 4\pi E_{ps} / \lambda_{ps}^3 = E_{ps} / 2\pi^2 r_{ps}^3 = 4\pi / e^* \lambda_{ps}^3$  (Joules/m<sup>3</sup>) Every ZPE quantum is coupled to a volume  $V^* = e^* / (df/dt)$  and so defines the quantization of spacial volume in terms of the ZPE, as well as the 'physical consciousness' contained in that volume.

The  $V^*$  here denotes the resonant quantum volumized eigenstate in a minimized spacetime volumar and NOT in terms of spacial volume, but in the form of an ENTROPY COUNTER of 'statistical permutation self-states' operation upon the 'Spacial Consciousness' quantum  $e^*=1/E_{ps}=1/E_{ss}\cdot f_{ps}^2=f_{ss}/h$ .

The self-frequency of the mass quantum so can be expressed formally as  $f_{ss}=he^*$  for the time instanton  $t_{ss}=f_{ss}$ , the latter triggering the 'inertialisation' of the post-inflationary cosmology in the so-called Quantum Big Bang, precisely  $3.333 \times 10^{-31}$  seconds\* following the 'string epoch' of the matter wave inflation (detailed and referenced elsewhere on this site). But it is the supermembrane coupling between the gravitational (photonic) mass  $M_g$  as given by the vibratory sourcesink string with the inertial mass  $M_i$  as given by the winding sinksources the string, which is the primary causation for this Quantum Big Bang, following the string-parametric de Broglie wave matter inflation.

Rewriting  $f_{ss}=he^*$  then describes this coupling in the ACTION=EnergyxTime of the Planck Constant in the finestructure  $f_{ss}=\text{Energy}^* \times \text{TimeInstanton} \times e^*$  for the Unity Condition of F-Space in  $1=E^*e^*$  that is the original definition of  $e^*=1/E^*$  as the definition for the 'Physical Consciousness of Space'.

Generally, then, the permutative entropy counter  $df/dt|_{\max}=f_{ps}^2$  gives precisely  $9 \times 10^{60}$  frequency eigenstates as the coupling constant between the two modes of the superstring; whilst its inverse defines the minimum as the 'Singularity' 'Null-State' or 'No Consciousness' state as  $1/(9 \times 10^{60}) \sim 0$ .

$df/dt|_{\max} = \lim\{[f_{ps} - t_{ps}]/t_{ps}\} = f_{ps}/t_{ps} - 1 = f_{ps}^2 - 1 = f_{ps}^2$  in the limit for  $9 \times 10^{60}$  permutation self-states

$df/dt|_{\min} = dt/df|_{\max} = \lim\{t_{ps}/[f_{ps} - t_{ps}]\} = \lim\{f_{ss}/[(1/f_{ss}) - f_{ss}]\} = f_{ss}^2/[1 - f_{ss}^2] = f_{ss}^2$  in the limit as  $1/f_{ps}^2$

This is the universal sourcesink/sinksources volumar for the supermembrane  $E_{ps}.E_{ss}$  coupled in brane modular duality and solves the 'cosmological constant' problem in a revision of the Friedmann cosmology.

By introducing a quintessence for the harmonic oscillator modal energy eigenstates  $|E_{ps}| = \sum\{\frac{1}{2}+N\}hf_{ps}$  for supermembrane  $E_{ps}.E_{ss}$  in the Zero-Point-Energy, the quantum description for spacetime crystallizes as a parameter space between maximized and minimized oscillation modes for the heterotic string class HE(8x8) as 10-dimensional expressions for the 11-dimensional membrane spacetime as the cosmological boundary mirroring an open ended Minkowski cyclically flat expanding cosmology in a closed de Sitter cosmology.

The lower dimensional universe so becomes cyclically bounded within an infinitely expanding unbounded higher dimensional cosmology with the cyclicity of the gravitationally retarded de Sitter universe quantum tunneling in the cosmology of the multiverse.

The Awareness operator applicable for all universal space so can fluctuate between the quasi-zero state and the maximized resonance state in the factor of  $81 \times 10^{120}$  and a value 'measured' by contemporary standard cosmological models as characteristic of the density discrepancy between the Planck-(ZPE)-Density  $\{\rho_P=m_P/V_P=c^5/\pi h G_o^2\} \sim 9.4 \times 10^{94}$  (kg/m<sup>3</sup>) and the actual matter density measured in the universe

$\rho_{\text{critical}}=3H_o^2/8\pi G_o \sim 3.8 \times 10^{-27}$  (kg/m<sup>3</sup>) from the inner 10D observer frame and

$\rho_{\text{critical}}=H_o^2/4\pi^2 G_o \sim 8.0 \times 10^{-28}$  (kg/m<sup>3</sup>) from the outer 11D observer frame of the Riemannian hypersphere as a 3D boundary of the 4-ball  $V_4=\frac{1}{2}\pi^2 R^4$  for  $dV_4/dR=2\pi^2 R^3$  as a 3-dimensional surface descriptive for the overall topology of the standard cosmology.

The dimensionless ratios of  $\rho_P/\rho_{\text{critical}}$  then indicate the ZPE/Critical energy discrepancies in the factors of the permutation string self-states in the factors of  $2.5 \times 10^{121}$  and  $1.2 \times 10^{122}$  respectively.

The ZPE-quantum  $E_{ps}=E^*$  so represents the kernel or core for any region of space containing a maximized 'physical consciousness' given by  $1/E^*=e^*$  Star Coulombs ( $C^*$ ).

The quantitative volume  $V$  for this consciousness is minimized in  $V_{ps}^*=e^*/f_{ps}^2$  in sourcesink resonance to the vibratory superstring modality and is in modular duality (as a monadic dyad or monadic duad) to its coupled sinksource resonance of its winding mode in its quantum modular maximization of  $V_{ss}^*=e^*f_{ps}^2$ .

The minimum calculates as  $V_{ps}^*=e^*/f_{ps}^2=1/1.8 \times 10^{58}$  permutation states and translates to a 3D volume of measurement  $R$  with a Compton radius  $R_{compton}=h/2\pi mc=c/2\pi f_{compton}=c/\omega_{compton}$  with angular velocity  $\omega=2\pi f$  and for  $R_{compton}=R_{RMP}(ss)=(e^*f_{ss}^2/2\pi^2)^{1/3} \sim 1.4 \times 10^{-20}$  meters for a Compton Energy of about 2.2 microjoules or as 14.03 TeV (as the maximum design capacity of the Large Hadron Collider or LHC located at Geneva, Switzerland comprised of two individuated colliding proton beams).

The precise ratio between the ZPE-kernel and the 'Space Consciousness' surrounding this core becomes:

Wormhole-Radius/Space-Consciousness-SourceSink-Radius for  $r_{ss}=2\pi\lambda_{ss}=2\pi/\lambda_{ps}=1/r_{ps}$  and  $f_{ss}\lambda_{ss}=1/c$  is:

$$r_{ps}/R_{RMP}(ss)=r_{ps}/R_{RMP}=(2\pi^2/e^*r_{ss}^3 \cdot f_{ss}^2)^{1/3}=c(f_{ss}/4\pi e^*)^{1/3}=(c^3 \cdot f_{ss}/8\pi R_e)^{1/3} \sim 1/887.11 \text{ (dimensionless).}$$

The string coupling defines  $c=\lambda_{ps}f_{ps}=1/\lambda_{ss}f_{ss}$ , rendering the Minkowski lightspeed constant  $c$  as dimensionless in the Lightpath  $X_{ps}=ct_{ps}=cf_{ss}$ .

This defines the quantum gravitational coupling of the gravitational mass element  $m_{ss}$  to the observed and measured elementary particle masses in QFT and Quantum-Chromodynamics (QCD) in the 'chromaticity' or 'colour charging' of gluonic gauge interaction transmitters being identifiable as the Magneto Charges defined in Star Coulombs ( $C^*$ ).

The corresponding maximum then couples in macro quantization to the micro quantized quantum gravitational Magneto Charges in  $V_{ss}^*=e^*f_{ps}^2=4.5 \times 10^{63}$  permutation states for a characterizing 'Galactic Volumar' in  $R_{RMP}(ps)=(e^*f_{ps}^2/2\pi^2)^{1/3}=(e^*/2f_{ss}^2\pi^2)^{1/3} \sim 6.1 \times 10^{20}$  meters or so 64,650 lightyears and a displacement scale which is then 'haloed' by the winded string parameter  $r_{ss}=1/r_{ps}=2\pi\lambda_{ss} \sim 6.3 \times 10^{22}$  meters or 6,648,875 lightyears and as the displacement scales observed by the standard cosmology.

Correspondingly, the Anti-Wormhole-Radius/Space-Consciousness-SinkSource-Radius is:

$$r_{ss}/R_{RMP}(ps)=(16\pi^5\lambda_{ss}^3/e^*f_{ps}^2)^{1/3}=(16\pi^5/f_{ss}e^*c^3)^{1/3}=(8\pi^5/f_{ss}R_e c^5)^{1/3} \sim 102.85$$

$$\text{As } r_{ps}/r_{ss}=r_{ps}^2=(cf_{ss}/2\pi)^2 \text{ and } (f_{ss}/f_{ps})^{2/3}=(f_{ss})^{4/3}=(4\pi^2r_{ps}/r_{ss}c^2)^{2/3}$$

$$R_{RMP}(ss)/R_{RMP}(ps)=(f_{ss}/f_{ps})^{2/3}=(f_{ss})^{4/3}=(4\pi^2r_{ps}/r_{ss}c^2)^{2/3}$$

for  $\{R_{RMP}(ss)/R_{RMP}(ps)\}^3=(f_{ss}/f_{ps})^2=(f_{ss})^4=(4\pi^2r_{ps}/r_{ss}c^2)^2 = \{1/81 \times 10^{120}\} \sim \text{Critical Density/Planck Density as the awareness operator fluctuation range.}$

$$\rho_{Planck}/\rho_{critical}=\{2\pi c^5/hG_o^2\}/\{3H_o^2/8\pi G_o\}=\{16\pi^2c^5/3hG_oH_o^2\}=\{1.855079 \times 10^{96}\}/\{3.78782 \times 10^{-27}\} \sim 81 \times 10^{120}$$

$$= 4.897 \times 10^{122} \text{ in a de Sitter closed EMR 10D-cosmology for which } \Omega=\Omega_{baryon}+\Omega_{MDM/RMP}+\Omega_{DE}=1$$

$$\rho_{Planck}/\rho_{critical}=\{2\pi c^5/hG_o^2\}/\{H_o^2/4\pi^2G_o\}=\{8\pi^3c^5/hG_oH_o^2\}=\{1.855079 \times 10^{96}\}/\{1.78497 \times 10^{-26}\} \sim 81 \times 10^{120}$$

$$= 1.03928 \times 10^{122} \text{ in an Anti-de Sitter closed EMMR 11D-cosmology for which } \Omega=\Omega_{baryon}+\Omega_{MDM/RMP}+\Omega_{DE}=1$$

This is the universal sourcesink/sinksource volumar for the supermembrane  $E_{ps}.E_{ss}$  coupled in brane modular duality.

The 'Physical Consciousness' in the standard cosmology now crystallizes as being associated with biovital lifeforms, occupying space, and as evolving in the dynamics of (holographic) fractals of the encompassing 'consciousness envelope' aka the galactic cells of macro-quantized entities.

This bio vitality is defined in a 'kernel consciousness' inherent in space itself via the string-coupled modalities, mimicking the overall expansion of the thermodynamic (and stochastic) universe.

This process can be comprehensively described as the EVOLUTION of Core-Consciousness in its Spatial Occupancy.

The Definition of 'Life' must so fundamentally be based on the string coupling between the two modalities and as two modes of operation, which quantum relatively entangle the micro-quantum characterised by the 'wormhole core' as a function of the nuclear interaction scale and where the classical electron radius  $R_e$  is also the scale of the magneto-asymptotic confinement of gluons in the definition of the magneto charges and so becomes the limiting quantum geometric template for the nuclear gauge interactions and the 'Higgs Bosonic' blueprint at the 3 Fermi scale.

'Life' then becomes the cosmos-evolutionary consequence of a quantum geometry defining the spacial configurations of the supermembranes as superstring couplings. Therefore, the most basic and primordial 'lifeforms' such as viruses, bacteria and fungi follow highly geometrized patterns in Platonic- and Archimedean solids, characterised by highly symmetrical arrangements of their molecular and atomic constituents. The most elementary 'life form' is the crystalline arrangements of the self-replicating pattern.

This originally manifested in so called quasicrystals of five folded symmetry, such as can be observed in Shechtmanites and the Penrose tiling.

The underpinning cosmology of the decoupling and breaking of the so termed Planck-Symmetry transformed the Planck-String into 5 classes of superstring: this 'breaking of unification' following a pentagonal supersymmetry at the core of all 'natural laws'.

For a 'lifeless' mass-only universe then the self-frequency of mass in the  $f_{ss}$  sinksource superstring would define the awareness operator as minimized in  $V^*_{min}=e^*/(f_{ss}^2)=e^*f_{ps}^2$

Corollarily, the 'fully life-conscious' universe (attained after an infinite linear time evolution of the descriptive cosmology) would be defined in  $V^*_{max}=e^*f_{ss}^2$ .

We can now relate the 'spacial consciousness' in terms of the universe's inertia content to the volume occupied by mass. As there are  $(R_{Hubble}/r_{ps})^3 \sim 10^{147}$  spacetime quanta in the asymptotic string universe of 10D and bounded by the membrane universe of 11D as an extremal Strominger braned Black Hole say and the sinksource (winded string)  $E_{ss}=hf_{ss}=m_{ss}c^2=2.222... \times 10^{-64}$  J; we can define a 'Consciousness-Density per unit mass'  $\rho_{crmp}$  for this 11D-'Mother-Black Hole' in Witten M-Space in dyadic coupling with a 12D-'Father White Hole' in Vafa-F-Space (MBH and FWH).

The M-Space MBH defines the Hubble horizon in its' closure mass' :

$$M_{Hubble}=R_{Hubble} \cdot c^2/2G_o=\Sigma m_{ss}=Nm_{ss} \sim 6.4706 \times 10^{52} \text{ kg}$$

$$\rho_{crmp}=e^*(R_{Hubble}/r_{ps})^3/M_{Hubble}=2G_o e^* R_{Hubble}^2/r_{ps}^3 c^2 = 7.81685 \times 10^{96} \sim 83.2 \rho_{Planck} C^*/\text{kg}$$

This is about 83.2 times the Planck-Density for  $M_{Hubble}$  and 2.34 times the Planck-Density applied to the baryonic mass seedling  $M_o=0.0281M_{Hubble}$ .

The 'Base Inertia Consciousness' (BIC) per minimal mass quantum  $m_{ss}$  then calculates as  $m_{ss}\rho_{crmp}=(2.46913\times 10^{-81})(7.81685\times 10^{96})=1.930\times 10^{16} C^*$  and for a count of  $N=2.6206\times 10^{133} m_{ss}$  as the inertia distribution of the  $BIC_{Universe}=5.058\times 10^{149} C^*$ .

A characteristic mass of 1 kg as  $4.05\times 10^{80}$  mass quanta, say as the standard liter of water in  $10^{-3}$  cubic meters of volume so possesses an inherent inertial consciousness of  $4.05\times 1.93\times 10^{96} C^*=7.82\times 10^{96} C^*$ .

This is the ZPE of the quantum standard models redefined in units of consciousness and this total includes 'dark matter' and 'dark energy' by the overall mass distribution  $Nm_{ss}=\sum m_{ss}$  from the evolution of the  $\Omega_o=M_o/M_{Hubble}$  - Einstein Lambda QBBS instanton-Inflaton cosmology.

In terms of the volume of 1 liter; however, the 'spacial consciousness' quantizes in the form of the VPE quantum  $E_{ps}=1/e^*$  per unit volume and which is the source energy Vortex-Potential-Energy quantum volumar  $VPE = E_{ps}/2\pi^2r_{ps}^3 = 2.5133\times 10^{64} [J/m^3]^*$ .

The 'inertia consciousness' of 1 liter of water so relates the BIC of  $7.82\times 10^{96} C^*$  to a VPE or ZPE of  $2.51\times 10^{61} J/m^3$ .

The example of a simple rock serves as a culmination of this essay. A rock, occupying a volume  $V_{rock}$  carries an intrinsic Base-Consciousness due to its volume. This basic consciousness is given in the mass-frequency  $f_{ss}$  as the mass of the rock is quantized in a number count  $N$  of mass quanta  $m_{ss}$ . This mass of the rock is actually a higher-dimensional mass-current as a form of 'natural superconductivity'  $I_{ps}=2ef_{ps}$  superstring coupled in modular duality to  $I_{ss}=2ef_{ss}$ .

The rock can so also be described as a summation of displacement current elements  $I_{ss}=2e\lambda_{ps}/c$  according to the previously described equations of James Clark Maxwell's electromagnetic theory. Mass in its purest form so is nothing but 'static magnetoelectricity' or densified electromagnetic monopolar sourcesink current.

The non-densified form of mass is of course photonic, and should this photonic mass NOT be a derivative from the acceleration of electric Coulomb charges 'e' coupled to preexisting mass (say fusion protons in stars) BUT be a derivative from the acceleration of magneto charges 'e\*', then the resulting Electromagnetic Radiation is monadic or Monopolar EMMR and defines the so called 'SPIRIT' of metaphysical cosmologies and philosophies.

The rock of volume  $V_{rock}$  and as some summation  $\sum I_{ss}$  or  $\sum m_{ss}$  so describes an energetic self-state of the superstring coupling between the string dyadic of the micro quantum  $E_{ps}$  and the macro quantum  $E_{ss}$ . The interaction of the rock with its environment then, in elementary terms, becomes a dynamic of spacial interaction in the movements of the rock in potential and kinetic energy and an encompassing wave-particle quantum eigen state of environmental quantum entanglement (Mach's Principle) with self- and mutual electric and magnetic inductions and capacities and resistances.

All space quanta are associated, or quantum entangled with each other via the string coupling and as all spacetime volumars are defined by their ZPE-core and its 'haloed' or 'auric' envelope of the physical consciousness coupled to the volumars by the self-awareness operator  $df/dt$ ; the entire cosmology is rendered a unified kaleidoscope of holofractal self-interaction of the thus defined 'Cosmic Consciousness'.

A basic quantum consciousness then is multiplied and complexified in the interaction, self- and mutual, between spacetime volumars of varying sizes in the encompassing summation integrals of the initial- and boundary parameters of the cosmogenesis.



The phenomenon of 'life' then is characterised by the Awareness-Operator the Alpha-Omega  $\alpha\omega = df/dt$ , namely the 'Change in Frequency' over linearized Time  $t$  and where the sourcesink frequency for minimum impedance for the 'natural current flow' ( $I_{ps}$ ) forms the upper bound source-resonance of the vibratory string modality and the maximum impedance describes the 'natural current flow' ( $I_{ss}$ ) as the lower bound for the sink-resonance.

The 'lifeless' universe of the primordial Quantum Big Bang is in Sink-Resonance to the Ess sinksource as a macro quantum, manifesting the super galactic inertia in Black Holes as seedlings for mass agglomerations known as galaxies.

Coupled to those 'higher-D' Black Holes are however imaged 'higher-D' White Holes (Quasars) who as Source-Resonators manifest the Source-Resonance of the  $E_{ps}$  sourcesink as the micro quantum of the super braned cosmology from its cosmogony.

The purpose and reason for the universe of materiality so is found in the Coevolution of SourceSink Self-Consciousness as unified encompassment for the cosmic evolution with its individuated and dispersed holographic shards or holograms of this selfsame self-consciousness in evolvement.

The operator for this evolvement is spacial self-awareness and the ability to use a bio mind defined by the function of 'changing' or modulating the frequency received by an antenna, which can take the form of a biochemical and molecular arrangement of cellular units termed a 'brain'.

The biological evolution of brains, then accommodates the utility of the natural superconductive electricity embodied in space itself; the biochemical electricity of say electromagnetic brain waves representing a shadow function of the charge flow  $I = dQ/dt$  as a 'normal current flow' to the electromagneto monopolar supercurrents of the magneto charges aka the universal agents for physicalized spacial consciousness.

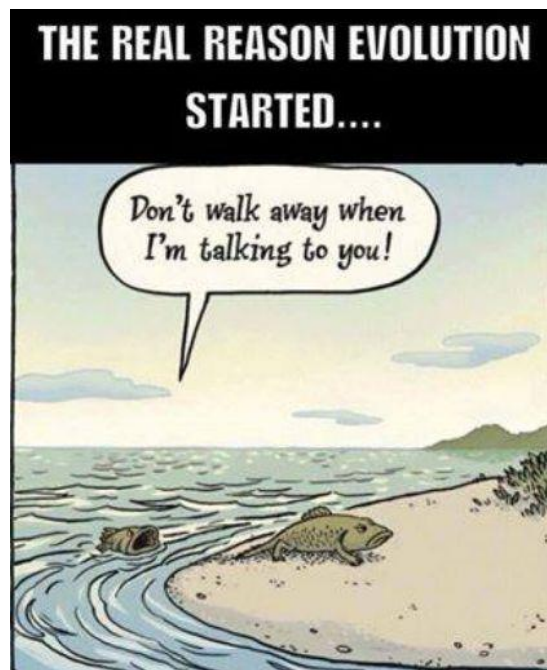

## VI: The Ylemic Universe and Quantum Gravitation from Superbrane Parameters

Many questions raised in the avenues of astrophysics and cosmology engage the quantum physics of the early universe following the QBBS.

When did the first stars and galaxies form from their black hole seeds and how did the dark matter cosmology change its nature from a decelerating universe into a universe apparently dominated by dark energy, responsible for an apparent acceleration of the universe, beginning about halfway through the age of the universe in its thermodynamic evolution? The answers are found in the timespace definitions to provide the initial boundary conditions for the spacetime instantaneity defined in the instanton-inflaton coupling.

The timespace defined five superstring classes, which defined the Zero-Point Planck Harmonic Oscillator from the undefined timespace to the five superstring classes in the timespace to be then mirrored by the Dirac monopole at the QBBS singularity as a double-sided Möbius-Klein supermembrane into spacetime.

At the Dirac singularity, the point particular nature became 'stringed' with the Weyl-Eps boson forming the physicalized manifestation of the Planck boson string for the initializing definition by the universal Logos Mathimatia.



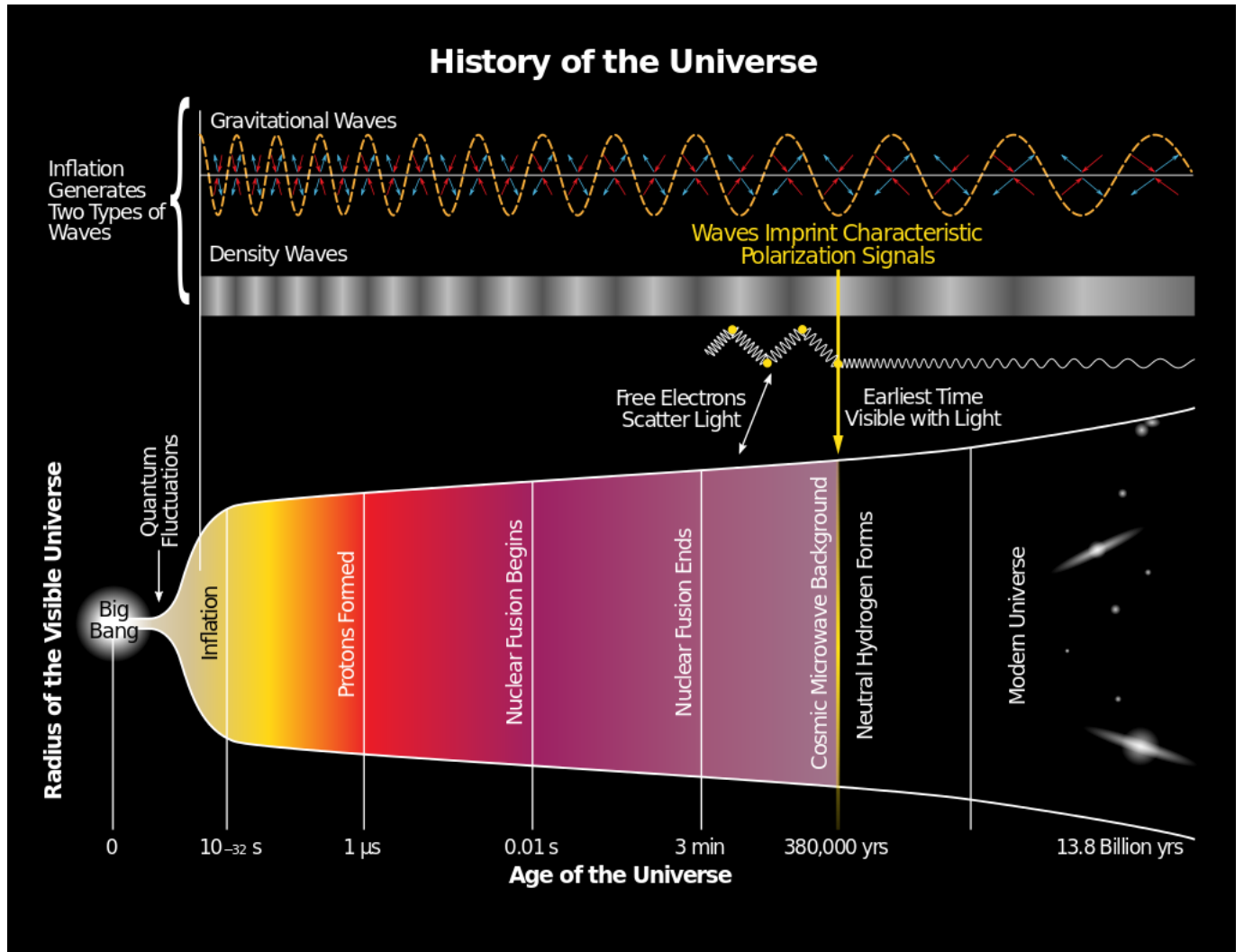

The Planck Harmonic Zero-Point Oscillator so became the Weyl-Harmonic Zero-Point Oscillator in a conformal mapping of the timespace onto the QBBS supermembrane and then manifesting the five superstring classes of the timespace in the spacetime.

String-Membrane Bosc	Classification	Realm	Time Formula	Manifest Time	Energy $hf=h/t$ J*/GeV*	Displacement Scale
Algo-Bosc	Time=Frequency $t_{ps}=1/f_{ps}=f_{ss}=1/t_{ss}$	Abstract Definiton	$n_{ps}=\lambda_{ps}/R_H$ $n_{ps}=H_0 t_{ps}=ct_{ps}/R_H$	$6.256 \times 10^{-49}$	$1.066 \times 10^{15}$ $6.635 \times 10^{24}$	$R_{ALGO}=2\pi L_{ALGO}=1.878 \times 10^{-40}$ $L_{ALGO}=r_{ALGO}=2.989 \times 10^{-41}$
Planck-Oscillation Bosc	Zero-Point Quantum Fluctuation	Timespace	$t_{OPL}=\nu \alpha t_{ps}$ $\nu \alpha R_{PL}/c=e/c^3$	$3.739 \times 10^{-44}$	$1.783 \times 10^{10}$ $1.110 \times 10^{20}$	$R_{OPL}=2\pi L_{OPL}=1.122 \times 10^{-35}$ $L_{OPL}=r_{OPL}=\nu \alpha L_{planck}=1.786 \times 10^{-36}$
Planck-Bosc	string class I Planck open	Timespace	$t_{PL}=2\pi R_{PL}/c$ $R_{PL}=\sqrt{\{hG_0/2\pi c^3\}}$	$4.377 \times 10^{-43}$	$1.523 \times 10^9$ $9.484 \times 10^{18}$	$R_{PL}=2\pi L_{planck}=1.313 \times 10^{-34}$ $L_{planck}=r_{PL}=2.090 \times 10^{-35}$
Monopole Bosc	Maximum 30[ec] for gravity $GM \leftrightarrow 2G_0M$	Timespace	$t_{MO}=h/E_{MO}$	$5.124 \times 10^{-42}$	$1.301 \times 10^8$ $8.100 \times 10^{26}$	$R_{MO}=2\pi L_{MO}=1.537 \times 10^{-33}$ $L_{MO}=r_{MO}=2.446 \times 10^{-34}$
Monopole Bosc	string class heterotic HO(32) closed	Timespace	$t_{MO}=2\pi R_{MO}/c$	$1.537 \times 10^{-40}$	$4.337 \times 10^6$ $2.700 \times 10^{25}$	$R_{MO}=2\pi L_{MO}=4.611 \times 10^{-32}$ $L_{MO}=r_{MO}=7.339 \times 10^{-33}$

<b>XL-Boson</b>	string class IIB closed	Timespace	$t_{XL}=2\pi R_{XL}/c$	$2.202 \times 10^{-39}$	$3.028 \times 10^5$ $1.885 \times 10^{15}$	$R_{XL}=2\pi L_{XL}=6.606 \times 10^{-31}$ $L_{XL}=r_{XL}=1.051 \times 10^{-31}$
<b>Ecosmic-Boson</b>	string class IIA closed	Timespace	$t_{EC}=2\pi R_{EC}/c$	$6.618 \times 10^{-34}$	0.833 $5.189 \times 10^9$	$R_{EC}=2\pi L_{EC}=1.985 \times 10^{-25}$ $L_{EC}=r_{EC}=3.159 \times 10^{-26}$
<b>False Vacuum Higgs-Boson Upper</b>	Higgs string	Timespace	$G_0 M_0 t_{ps}/R_{HC}^2$	$4.672 \times 10^{-33}$	0.143 $8.885 \times 10^8$	$R_{Higgs}=2\pi L_{Higgs}=1.402 \times 10^{-24}$ $L_{Higgs}=r_{Higgs}=2.231 \times 10^{-25}$
<b>False Vacuum Higgs-Boson Lower</b>	Timespace OPL-Image	Timespace	$\sqrt{\alpha} t_{ps}$	$2.847 \times 10^{-32}$	0.0234 $1.458 \times 10^8$	$R_{Higgs}=2\pi L_{Higgs}=8.541 \times 10^{-24}$ $L_{Higgs}=r_{Higgs}=1.359 \times 10^{-24}$
<b>Weyl-Boson-QBBS radius</b>	string class heterotic HE(64) closed	QBBS Spacetime	$t_{ps}=r_{ps}/c$	$5.305 \times 10^{-32}$	0.0126 $7.823 \times 10^7$	$r_{ps}=\lambda_{ps}/2\pi=1.592 \times 10^{-23}$
<b>Weyl-Boson-QBBS wavelength</b>	Closed string class heterotic HE(64) closed	QBBS Spacetime	$t_{ps}=2\pi r_{ps}/c$	$3.333 \times 10^{-31}$	$2 \times 10^{-3}$ $1.245 \times 10^7$	$\lambda_{ps}=10^{-22}$
<b>Weyl-Boson-QBBS modular wavelength</b>	string class heterotic HE(64) closed	QBBS Spacetime	$t_{ps}=2\pi \lambda_{ps}/c$	$2.094 \times 10^{-30}$	$3.184 \times 10^{-4}$ $1.982 \times 10^6$	$2\pi \lambda_{ps}=6.283 \times 10^{-22}$
<b>False Vacuum Higgs- Boson Lower</b>	Spacetime OPL-Image	Spacetime	$t_{ps}/\sqrt{\alpha}$	$3.902 \times 10^{-30}$	$1.709 \times 10^{-4}$ $1.064 \times 10^6$	$R_{Higgs}=2\pi L_{Higgs}=1.171 \times 10^{-21}$ $L_{Higgs}=r_{Higgs}=1.864 \times 10^{-22}$
<b>False Vacuum Higgs- Boson Upper</b>	Higgs string	Spacetime	$R_{HC}^2 t_{ps}/G_0 M_0$	$2.378 \times 10^{-29}$	$2.803 \times 10^{-5}$ $1.746 \times 10^5$	$R_{Higgs}=2\pi L_{Higgs}=7.134 \times 10^{-21}$ $L_{Higgs}=r_{Higgs}=1.135 \times 10^{-21}$
<b>Ecosmic Boson</b>	Cosmic Ray Image Knee	Spacetime	$t_{ps}^2/t_{EC}$	$1.679 \times 10^{-28}$	$3.971 \times 10^{-6}$ $2.472 \times 10^4$	$R_{EC}=2\pi L_{EC}=5.037 \times 10^{-20}$ $L_{EC}=r_{EC}=8.017 \times 10^{-21}$
<b>XL-Boson</b>	Cosmic Ray Image Ankle	Spacetime	$t_{ps}^2/t_{XL}$	$5.046 \times 10^{-23}$	$1.321 \times 10^{-11}$ $8.225 \times 10^{-2}$	$R_{XL}=2\pi L_{XL}=1.514 \times 10^{-19}$ $L_{XL}=r_{XL}=2.410 \times 10^{-20}$
<b>Monopole Boson</b>	Cosmic Ray Image Toe	Spacetime	$t_{ps}^2/t_{MO}$	$7.229 \times 10^{-22}$	$9.222 \times 10^{-13}$ $5.742 \times 10^{-3}$	$R_{MO}=2\pi L_{MO}=2.169 \times 10^{-13}$ $L_{MO}=r_{MO}=3.451 \times 10^{-14}$ Universe the size of the Compton quantum scale $R_{compton}=\hbar/mc$
<b>Monopole Boson</b>	Minimum 30[ec] for quantum gravity	Spacetime	$t_{MO}=\hbar/E_{MO}$	$2.169 \times 10^{-20}$	$3.074 \times 10^{-14}$ $1.914 \times 10^{-4}$	$R_{MO}=2\pi L_{MO}=6.507 \times 10^{-12}$ $L_{MO}=r_{MO}=1.036 \times 10^{-12}$ Universe the size of the wave matter de Broglie quantum scale $\lambda_{dB}=\hbar/mc$
<b>Planck Boson</b>	Planck boson Image	Spacetime	$t_{ps}^2/t_{PL}$	$2.539 \times 10^{-19}$	$2.626 \times 10^{-15}$ $1.635 \times 10^{-5}$	$R_{PL}=2\pi L_{PL}=7.617 \times 10^{-11}$ $L_{PL}=r_{PL}=1.212 \times 10^{-11}$ Universe the size of the Bohr atom scale $\lambda_{bohr1}=R_e/\alpha^2$
<b>Planck-Oscillation Boson</b>	Planck bounce Image	Spacetime	$t_{ps}^2/t_{OPL}$	$2.972 \times 10^{-18}$	$2.243 \times 10^{-16}$ $1.396 \times 10^{-6}$	$R_{OPL}=2\pi L_{OPL}=8.916 \times 10^{-10}$ $L_{OPL}=r_{OPL}=1.419 \times 10^{-10}$ Universe the size of an atom
<b>Algo Boson</b>	Genesis boson Image	Spacetime	$t_{ps}^2/t_{ALGO}$	$1.775 \times 10^{-13}$	$3.756 \times 10^{-21}$ $2.338 \times 10^{-11}$	$R_{ALGO}=2\pi L_{ALGO}=5.32558484 \times 10^{-5}$ $L_{ALGO}=r_{ALGO}=8.47593 \times 10^{-6}$ Universe the size of smallest life bio-organisms; cellular complex

This evolution is defined in the wormhole mass  $m_{weyl}=\{\lambda_{weyl}c^2/4\pi G_0\}$  transforming into the mass of the mother black hole  $M_H=\{R_{HC}^2/2G_0\}$  in using the time coordinate for the Sarkar daughter black hole given as the coordinate of the E-googol from the timespace definitions as the mass seedling  $M_0=\{R_{sarkar}^2/2G_0\} = (\text{proportionality constant } q_0)M_H$ .

The proportionality constant  $q_0$  is known as the deceleration parameter for the QBBS cosmology. The H-googol defined the Hubble event horizon and so the boundary conditions for the age and size for the protoverse as a seed for the multiverse emerging after one completion of the light path of the EMMR travelling in spacetime from the instanton to the inflaton.

The F-googol and the G-googol as counts of source energy wormhole quanta reduce the encompassing Riemann volumars in a factor of  $F/E=1.019538764 \times 10^{103}/1.006208782 \times 10^{112}=1.0132477 \times 10^{-9}$  and  $G/E=9.676924497 \times 10^{102}/1.006208782 \times 10^{112}=9.61721332 \times 10^{-10}$  to set a particular energy ratio between the light energy parameters and the dark energy parameters in the QBBS.

The light energy parameter refers to the part of Electromagnetic radiation (EMR) emerging from the instanton as the effect of the acceleration electropolar charge coupled to the wormhole mass  $m_{weyl}$  and as different from the Electromagnetic monopolar radiation of the EMMR, which is the effect of the acceleration of magnetopolar charge as given in the Dirac monopole manifesting from imaginary timespace as physicalized spacetime.

The dark energy parameter then refers to the part associated with the matter content of the QBBS and so the mass seedling  $M_0$  of the instanton defined in spacetime at the E-googol marker and as part of the encompassing dark energy mass of the mother black hole  $M_H$  of the Hubble event horizon.

The Riemann volumar  $R(n)=R_H\{n\}/\{n+1\}$  at the E-googol marker for the Strominger black hole so is calculated as  $2\pi^2 R_E^3=\{E\}\{2\pi^2 r_{weyl}^3\}$  for  $R_E=\sqrt[3]{E(\lambda_{weyl}/2\pi)}=3.43597108 \times 10^{14} \text{ m}^*$  for a time  $t_E=n_E/H_0=2.1506 \times 10^{12}/H_0=1,145,323.7 \text{ s}^*$  and a temperature  $T_E=1.163 \times 10^9 \text{ K}^*$  from  $T(n)=\sqrt[4]{\{H_0^3 M_0/1100\pi^2 \sigma_{SB}\} \cdot \{(n+1)^2/n^3\}}$

The Riemann volumar at the F-googol marker for the Strominger black hole so is calculated as  $2\pi^2 R_F^3=\{F\}\{2\pi^2 r_{weyl}^3\}$  for  $R_F=\sqrt[3]{F(\lambda_{weyl}/2\pi)}=3.45107750 \times 10^{11} \text{ m}^*$  for a time  $t_F=n_F/H_0=2.1601 \times 10^{15}/H_0=1150.36 \text{ s}^*$  and a temperature  $T_E=2.0614 \times 10^{11} \text{ K}^*$ .

The Riemann volumar at the G-googol marker for the Strominger black hole so is calculated as  $2\pi^2 R_G^3=\{G\}\{2\pi^2 r_{weyl}^3\}$  for  $R_G=\sqrt[3]{G(\lambda_{weyl}/2\pi)}=3.39155801 \times 10^{11} \text{ m}^*$  for a time  $t_G=n_G/H_0=2.1228 \times 10^{15}/H_0=1130.52 \text{ s}^*$  and a temperature  $T_E=2.0885 \times 10^{11} \text{ K}^*$



For  $F'=(2G-F)=9.158461354 \times 10^{102}$  space quanta =  $R_{F'}=\sqrt[3]{F'}(\lambda_{weyl}/2\pi)=3.32987275 \times 10^{11} \text{ m}^*$  for a time  $t_{F'}=n_{F'}/H_0=2.0842 \times 10^{15}/H_0=1109.96 \text{ s}^*$  and temperature  $T_E=2.1173 \times 10^{11} \text{ K}^*$  and where googol  $F'$  is the mirror image of googol  $F$  about googol  $G$

Those Strominger black holes then became physically manifest as the first Gamow ylem protostars, physicalizing the potential matter vortices from the initial potential mass distribution of the  $M_0$  matter seedling.

Ylemic neutron stars form the boundary conditions for quark-gluon stars with characteristic radii relating the temperature of the universe at the particular  $n$ -cycle coordinate to vortex potential energy concentrations materializing from the matter distribution of the matter seedling  $M_0$  as ylemic neutron stars.

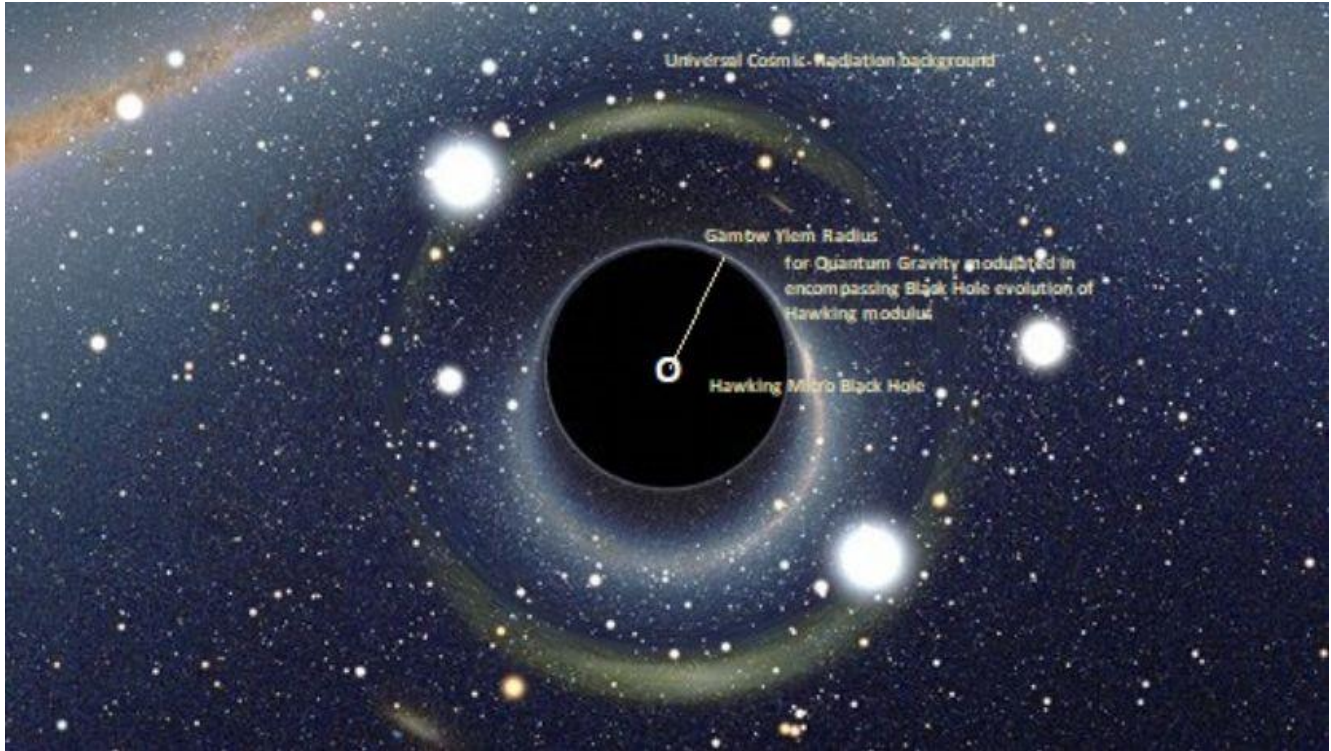
The thermodynamic evolution of the universe then relates a general evolution of neutron stars with specific nuclear densities with respect to the cosmic radiation background to the Hawking properties of black holes as a background energy matrix originating from the distribution of a baryonic mass seedling and its coupling to the QBBS parameters.



**Bekenstein    Hawking**

**Black holes carry (or hide) information.**

**Entropy**

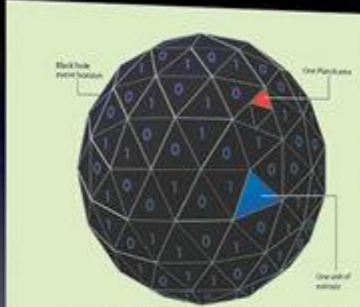

ENTROPY OF A BLACK HOLE is proportional to the area of its event horizon, the surface from within which even light cannot escape the gravity of the hole. Specifically, a hole with a horizon (opening) of Planck areas has 1 unit of entropy. (The Planck area, approximately  $10^{-70}$  square centimeters, is the fundamental quantum unit of area determined by the strength of gravity, the speed of light and the size of quantum.) Considered as information, it is 0 if the entropy were written on the event horizon, with each bit (each digit 1 or 0) corresponding to four Planck areas.

**A new view on Gravity and the Cosmos (Erik Verlinde)**

**Information**



$$S = \frac{\text{Area}}{4Gh} c^3$$

The amount of information is determined by the area of the black hole horizon.

**The Laws of Gravity take the form of the Laws of Thermodynamics**

**1st Law**

$$dM = \frac{g}{2\pi} \frac{dA}{4G}$$

$$dE = TdS$$

$$S = k_B \frac{Ac^3}{4Gh}$$

$$k_B T = \frac{hg}{2\pi c}$$

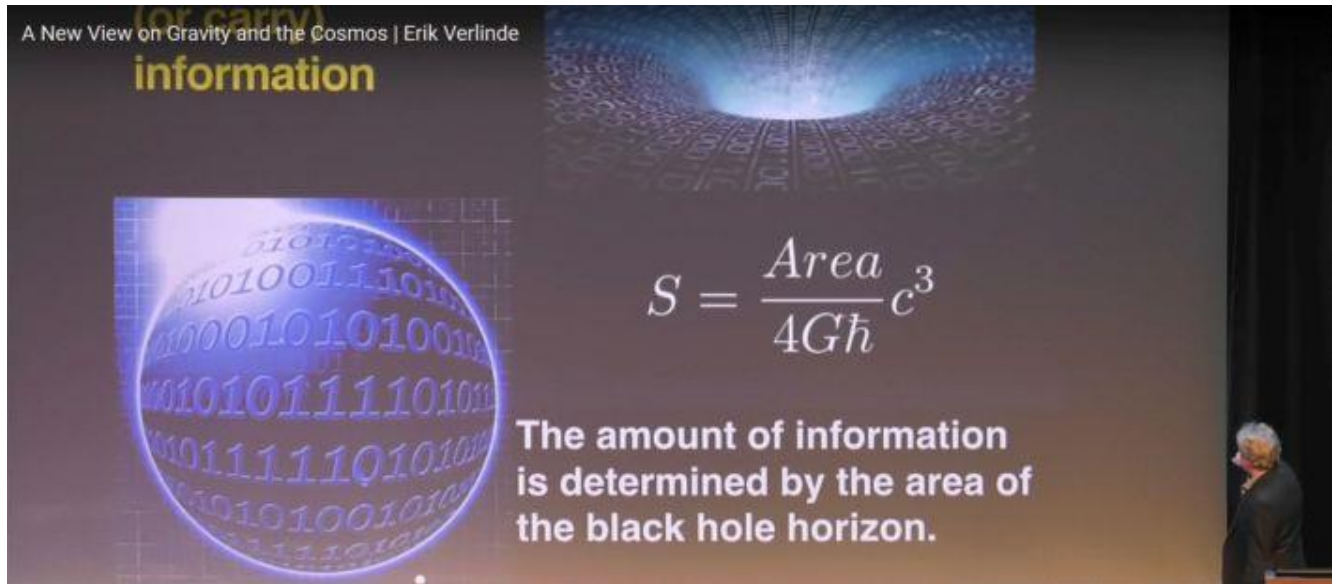

The Hawking-Gamow Temperature Unification for classical and quantum gravitation is so derived as the temperature ratio:

$$T_{\text{Hawking}}/T_{\text{ylem}} = 1 = hcR_e^3/2\pi G_0 m_c^2 R_{\text{ylem}}^2 R_{\text{Hawking}}$$

$$= R_e^3/\alpha_{\text{nucleon}} \cdot R_{\text{ylem}}^2 R_{\text{Hawking}} \text{ with } \alpha_{\text{nucleon}} = \alpha_{\text{planck}} \alpha_e^{18} .$$

Hawking's micro black holes play a decisive role in the universal cosmology, as they modulate the quantum gravitational universe of the creation event with the classical gravitation of the spacetime geometry. In particular the micro black holes form the energy centers within encompassing vortices of potential energy modelled on the Jeans length applied to the general temperature evolution of the universe.

The ylemic radius is independent from mass as a function of the ylemic Gamow temperature, decreases with time and only depends on atomic and subatomic parameters as the classical electron radius  $R_e$  and the primordial nucleon as the ylemic neutron  $m_c = m_{\text{planck}} \alpha^9$  from the gravitational finestructure  $\alpha_g = 2\pi m_c^2 / hc = m_c^2 / m_{\text{planck}}^2 = \alpha_e^{18}$  for  $k_B$  the Stefan-Boltzmann constant for thermodynamic energy,  $R_e$  the classical electron radius,  $G_0$  the quantum gravitational constant and  $m_c$  the proto-nucleonic mass from the gravitational finestructure in:

The Gamow Ylemic dineutronic radius for Black Hole Temperature evolution:

$$R_{\text{ylem}} = \sqrt{\{k_B T_{\text{ylem}} R_e^3 / G_0 m_c^2\}} \dots \dots \dots [\text{Eq.V-1}]$$

The ylem radius so is descriptive for a spacetime metric coupling the quantum gravitation of a Hawking micro black hole at the high fusion temperatures of the early universe to its later manifestation in neutron stars defined by their nuclear densities with electron and neutron degeneracies. The maximum temperature for a black hole is given at a nexus point in the thermodynamic evolution of the universe, known as the bosonic unification of the background temperature with that of the bosonic temperature of the Weyl wormhole of the QBBS. The universe had cooled to a temperature of  $1.42 \times 10^{20}$  Kelvin from the QBBS temperature of a temperature of  $2.30 \times 10^{36}$  Kelvin at a time of 2 nanoseconds from the instanton.

At this time, the ylem dark matter-RMP-Einstein quintessence halo with a radius of  $6.26 \times 10^8$  meters encompassed a lower dimensional universe of just 1.1382 meters across in the higher dimensional universe created by the inflaton and the hyper accelerated de Broglie wave matter EMMI light path.

$$\text{Hawking Modulus } HM = M_{\text{Hawking}} T_{\text{Hawking}} = m_{\text{Planck}} \cdot E_{\text{Planck}} / k_B = \sqrt{\{hc/2\pi G_o\} \{1/2 m_{\text{Planck}} \cdot c^2 / k_B\}} \\ = hc^3 / 4\pi G_o k_B = \{M_{\text{Hminin}} \cdot T_{\text{Hmax}}\} = \{r_{\text{ps}} c^2 / 2G_o\} \{T_{\text{ps}}\} = 9.1317939 \times 10^{23} \text{ [kgK]}^*$$

The maximum Hawking temperature for micro black holes so is given as  $T_{\text{ps}} = T_{\text{weyl}}$  as a maximized bosonic or Einstein-Boson-Condensate temperature for the QBBS.

$$\text{The Hawking-Unruh form for the Hawking Modulus is } HUM = M_{\text{Hawking}} \cdot T_{\text{Hawking}} \\ = m_{\text{planck}} \cdot T_{\text{planck}} / 8\pi = hc^3 / 16\pi^2 G_o k_B = 7.2668507 \times 10^{22} \text{ [kgK]}^*$$

for the extent of the Unified Field of Quantum Relativity (UFOQR) requiring  $1440^\circ$  or  $8\pi$  radians to repeat its superposed electromagnetic-gravitational wavefunction.

$$8\pi \cdot HUM = M_{\text{Hawking}} T_{\text{Hawking}} = m_{\text{Planck}} \cdot E_{\text{Planck}} / k_B = \sqrt{\{hc/2\pi G_o\} \{m_{\text{Planck}} \cdot c^2 / k_B\}} \\ = hc^3 / 2\pi G_o k_B \text{ for } HUM = hc^3 / 2\pi^2 G_o k_B = 7.266851 \times 10^{22} \text{ [kgK]}^*$$

The Unruh acceleration within a temperature background so relates to the surface properties of the holographic AdS-CFT (conformal field theory) cosmology and the entropy of a black hole in the Hawking-Bekenstein bound of  $S = 2\pi k_B A c^3 / 4G_o h$  in the UFOQR then becomes  $a_{\text{unruh}} = 2\pi c M_{\text{Hawking}} k_B T_{\text{Hawking}} / h$  and would give a black hole Hawking temperature of  $2.46 \times 10^{-19} \text{ K}^*$  for a gravitational acceleration of  $9.8 \text{ [m/s}^2\text{]}^*$ .

The entropy of the Hawking-Bekenstein cosmology therefore relates to the conformal mapping of the Planck displacement scale onto the Weyl-Eps displacement scale in entropy  $S = 1/4 \{Area / L_{\text{planck}}^2\} = 1/4 \{2\pi A c^3 / G_o h\}$ .

The Weyl-wormhole of heterotic supermembrane EpsEss and given by the sinusoidal waveform  $f_{\text{UFOQR}}(x) = \sin(3x/2) - \cos(3x/4)$  so represents the four Planck areas  $L_{\text{planck}}^2$  per information bit in its 12 monopolar current loops spanning a wave number of  $k=4$  in  $8\pi / \lambda_{\text{ps}}$  radians.

The Feigenbaum complexity upper bound for the universal base topology as chaos constant is given as  $\delta_{\text{Feigenbaum}} = 4.669201... < 4.712389 = 3\pi/2$  and the surface area for the Riemann 3-dimensional manifold is  $6\pi^2 R_3^2 = (3\pi/2)(4\pi R_3^2)$  for the Hawking-Unruh factor of  $4\pi = 6\pi^2 / (3\pi/2) = 12\pi^2 / 3\pi$  as a coefficient modulation in the multidimensional universe.

The spacetime volumar  $2\pi^2 r_{\text{ps}}^3$  so is compressed in the spacetime volumar  $4\pi r_{4D}^3 / 3$  in the Source energy per unit volume  $E_{\text{VPE-ZPE}} = 4\pi E_{\text{ps}} / \lambda_{\text{ps}}^3$  for  $r_{4D} = \sqrt[3]{\{3\pi/2\}} r_{\text{ps}} = 1.67654 r_{\text{ps}}$  in the surface area modulation  $6\pi^2 = 3\pi \cdot 4\pi/2$  in the dimensional reduction of the sphericity of the 3-ball  $V_4 = 1/2 \pi^2 R_4^4$  as a 3-dimensional surface  $dV_4 / dR_4 = 2\pi^2 R_3^3$  to the 2-ball  $V_3 = 4\pi R_3^3 / 3$  as the energy per unit volumar spacetime quantum for the wormhole integration of the multidimensional cosmology.

The quantized spacetime so becomes a summation of Susskind-Maldacena integrated wormhole quanta enabled to connect time-parallel extremal Strominger black holes as a closed dS universe and an open AdS universe as an Einstein-Podolsky-Rosen bridge. The region of spacetime connected by the two wormhole faces then describes the dark wormhole matter not intersecting the baryonic mass seed and is defined in the extremal quantum surface of the Page Time.



**A wormhole supermembrane spacetime continuity configuration from timespace**

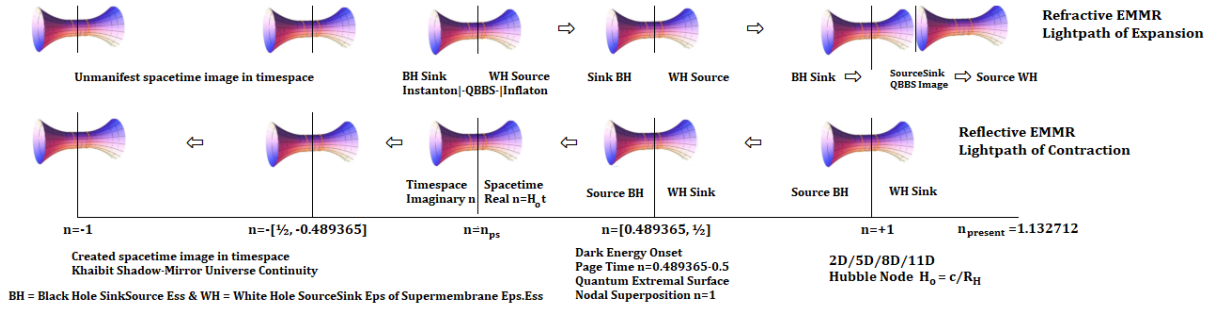

For the minimum Planck-Oscillator:  $E_{op} = \frac{1}{2}hf_{op} = \frac{1}{2}m_{op}c^2 = \frac{1}{2}k_B T_{op} = Mc^2/\#bits$   
 $= \{Mc^2 \cdot |l_{planck}^2\} / \{4\pi R^2\} = \{MG_0 h / 8\pi^2 c R^2\} = \{hg / 8\pi^2 c\}$  with gravitational acceleration  $g = G_0 M / R^2$  and  $M = gR^2 / G_0$  for  $k_B T = hg / 4\pi^2 c = \{\text{String T-Duality modulation factor } \zeta\} \{hg / c\}$   
 $\zeta = \text{Linearization of Compton wave matter in de Broglie wave matter}$

$$r_{ps}/r_{ss} = \{\lambda_{ps}/2\pi\} / \{2\pi\lambda_{ss}\} = \{\lambda_{ps}^2/4\pi^2\} = \{1/4\pi^2 \cdot \lambda_{ss}^2\} = 10^{-44}/4\pi^2$$

for  $4\pi = HM/HUM = \{hc^3/4\pi G_0 k_B\} / \{hc^3/16\pi^2 G_0 k_B\}$

The gravitational acceleration in Quantum Relativity  $g$  as the Weyl-wormhole gravitational acceleration then is  $g_{ps} = c \cdot f_{ps}$  for  $E_{ps} = hf_{ps} = hc \cdot f_{ps}/c = k_B T_{ps} = hg_{ps}/c$  and generalizes as the Milgröm acceleration  $a_{mil} = -2cH_0/(n+1)^3$  in the cosmology in  $g \propto cH_0$ .

$$dE = TdS \text{ for } c^2 dM = (2k_B T \cdot c^3) dA / 4G_0 h \text{ for } dM = \{hg c / 2\pi c\} dA / \{4G_0 h\} = \{g / 8\pi G_0\} dA \text{ } dM/dA = \{g / 8\pi G_0\}$$

$$dS/dA = k_B / 4l_{planck}^2 = 2\pi k_B c^3 / 4hG_0 \text{ from Entropy } S = k_B A / 4l_{planck}^2 = \pi c^3 k_B A / 2G_0 h \text{ with } dS = 2\pi k_B \text{ from } dE/dS = T$$

and  $E = \sum TdS = k_B T$  in the quantum self-state  $dM/dS$

$$= \{dM/dA\} \cdot \{dA/dS\} = \{g / 8\pi G_0\} \cdot \{4l_{planck}^2 / k_B\} = \{g l_{planck}^2 / 2\pi k_B G_0\} = \{hg / 4\pi^2 k_B c^3\} = \zeta \{hg / k_B c^3\}$$

As indicated by cosmological models, including Susskind, Maldacena, Bousso and Verlinde, relating string theory with gravitation and the holographic principle; crystallizes that quantum information from timespace allows gravitation and all interactions to emerge in spacetime.

The transition from timespace into spacetime then is enabled by the Dirac string and the mirror modular dualities of string-membrane realm imaging the string parameters from timespace into spacetime.

The primary physical parameter for the subsequently evolving cosmology then is the definition of temperature as a kinetic energy effect for the lower dimensional and gravitational universe and with entropy as a count of energy-frequency micro eigenstates as bits of information.

The higher dimensional information universe so forms a corollary in the EMMI light path of the monopolar source radiation to the EMI light path for the matter dependent electromagnetic radiation (EMR). As the EMR is produced by the dynamics of electropolar charges, as in the angular acceleration of protons in a fusion star; but the magnetopolar charges are accelerated in the frequency differential over time in  $df/dt$  as a radial independent angular quantum spin; the Unruh acceleration can be generalised to the gravitational acceleration  $g = GM/R^2$  for the entropic cosmology and bounded in the Schwarzschild metric in partitioning lightspeed  $c$  in the product of wavelength times frequency.

For a temperature  $T = \frac{hg}{4\pi^2 ck_B} = \frac{G_0 M h}{4\pi^2 ck_B R^2} = \frac{hc^3}{16\pi^2 k_B G_0 M}$  the square of the Schwarzschild metric results in  $4G_0^2 M^2 = R^2 c^4$

In particular, the definitions of the dark matter particle in the RMP and the Dirac monopole as the Weyl-wormhole indicate that for the first  $6.662 \times 10^{-29} = \text{Lightpath}/c$  seconds from the QBBS, the physical energy content of the universe was purely restmass photonic in forming the ylemic dineutron bosons as the primordial radiation background for the thermodynamic expansion of the universe.

As the volume of the universe at electroweak unification is  $2\pi^2 R_{EW}^3 = \{2.434875 \times 10^{87}\} \{2\pi^2 r_{ps}^3\}$ , the physicalised matter content in the universe from baryon seedling  $M_0$  consisted of  $2.43 \times 10^{87}$  dark matter particles in the form of bosonic ylemic dineutrons coupled as a doubled or squared matter colour charge template  $Y^2 C^2 M^2$  containing the soon to be born Higgs boson as the scalar Goldstone boson coupled to a spin conserving colour neutral graviphoton of spin +1 coupled to the RMP's negative quantum spin of -1.

The wave quark geometric  $Y^2 C^2 M^2 (-1)$  decays into two lefthanded neutrons each of quantum spin  $-\frac{1}{2}$  to manifest the charge-parity violation of the weak interaction and the suppression of antimatter in the form of the  $M^2 C^2 Y^2$  antimatter template for the Anti-Higgs boson and the Anti-RMP.

The graviphoton coupled to a matter weakon ( $W$ )(+1) can then couple to a weakly interacting neutron to flip the lefthanded neutron into a righthanded neutron in conjunction with an antimatter weakon ( $W^+$ )(-1) coupled to an anti-graviphoton conserving weak interaction parity across the mirror of the QBBS as the Dirac string with the Khaibit shadow-mirror universe.

The neutral current weakon ( $Z^0$ )( $\pm 1$ ) similarly engages anti-neutrino and neutrino interactions from their colour charged  $R^2 G^2 B^2 (+\frac{1}{2})$  and  $B^2 G^2 R^2 (-\frac{1}{2})$  templates, their Dirac form of weakonness being massless, but their Majorana form of unified field interaction resulting in the mass induction by the scalar Higgs (anti)neutrino of squared template form  $(R^4 G^4 B^4)(0)$  and  $B^4 G^4 R^4(0)$ .

The production of antimatter in the form of pair production in the UfoQR between monopolar current loops for junctions 6-7-8 became defined at the electroweak unification cycle coordinate in the QBBS.

The Dirac monopole is defined in the units of the gravitational parameter.  
or  $[m^3/s^2] = [\text{Volume}][\text{Angular Acceleration}]$  as:

$$e^* = 2R_e c^2 = 2R_e \{\lambda_{ps}^2\} \{f_{ps}^2\} = 1/E_{ps} \text{ for } 2R_e \{\lambda_{ps}^2\} = 2R_e \{360R_e/10^{10}\}^2 = \{2.592 \times 10^{-15}\} R_e^3 = e^*/f_{ps}^2 = e^* f_{ss}^2 = e^* (9 \times 10^{60})$$

entropy self-states

The RMP is defined in its volumar  $2\pi^2 R_{RMP}^3 = e^*/f_{ps}^2 = e^*/(9 \times 10^{60})$  entropy self-states) to define the ratio  $\{R_e/R_{RMP}\} = \sqrt[3]{\{2\pi^2/2.592 \times 10^{-15}\}} = 7.6154355 \times 10^{15}$  showing that so 7.615 quadrillion RMPs will fit into the source energy quantum and the inversion charge energy of the Dirac monopole and so the QBBS instanton. The radius of the RMP is given  $R_{RMP} = 1.411884763 \times 10^{-20} m^*$  from the source energy quantum definition for the classical electron radius of  $2.777... \times 10^{-15} m^*$ .

The unification condition for the physicalisation of the Dirac monopole as the t'Hooft-Polyakov monopole requires however the Mean Monopolar Quantum Bound (MQB) as the alignment of the Dirac monopole wavelength mapped onto the electron wavelength and this MQB is calculated from the quantization condition to align the Dirac wavelength with the mirror modular duality of the supermembrane EpsEss.

As the inversion properties apply throughout the cosmology defined by the googolplex markers EFGF,' the Dirac wavelength aligns the divergence between the product  $R_E R_e$  in the coupling of  $\lambda^*$  to  $R_E$  and  $r^*$  to  $R_e$  in the ratio  $= \eta_{MO} = (MQB/R_E R_e) = (1.351/0.9544) = 1.41555$  and in multiplying the RMP radius by  $(MQB/R_E R_e)$  for an effective dark matter displacement coordinate  $R_{RMPeff} = 1.9986 \times 10^{-20} \text{ m}^*$ .

$\lambda^* = 4.087933536 \times 10^{14}$ Monopolar mean classical bound	$2\pi r^* \lambda^*$ MQB=1.351	$2\pi r^* = 3.30485 \times 10^{-15}$ Monopolar mean quantum bound
$\Delta = +0.156$ $R_E^* = 3.6 \times 10^{14} = 360 \times 10^{12}$	$R_E^* R_e^* = 1$	$R_e^* = R_e = 10^{10} \lambda_{ps} / 360$
$R_E = \sqrt[3]{E(\lambda_{weyl}/2\pi)} = 3.43597108 \times 10^{14}$	$R_E R_e = 0.9544$	$R_e = 2.77777 \times 10^{-15}$
$\Delta = -0.145$ $R_{E,c2} = 4(8.2263 \times 10^{13}) = 3.2905 \times 10^{14}$	$R_{E,c2} R_e = 0.8753$	$R_e = 2.66017 \times 10^{-15}$

The RMP dominated era ended when the ylemic dineutron radius became equal to the size of the universe at a time about  $1/140^{\text{th}}$  of a second for a radius of  $2.14114 \times 10^6 \text{ m}^*$ .

This was the nexus for the RMP-Higgs ylemic quarkian geometry template to differentiate between the mesonic inner and the leptonic outer ring to kernel the proton in electroweak unification at a temperature of  $1.68 \times 10^{15} \text{ K}^*$  and when the dark matter universe became illuminated in the EMMI light path intersecting the RMP haloed universe.

The number of space quanta comprising the universe at RMP time is the size of the universe for cycle coordinate divided by  $2\pi^2 r_{ps}^3$

as a space quantum count  $\text{Eta}_{RMP} = \eta_{RMP} = R_{RMPeff}^3 / r_{ps}^3 = 1.9802 \times 10^9 = 1/5.0500 \times 10^{-10}$

For the googolplex E-FGF', the photon baryon ratios for the time of the primordial neutron decay from to 1150.36 – 1130.52 – 1109.96 – 229.821 seconds for a time interval from 880.14 to 900.70 to 920.54 seconds, the respective photon-baryon ratios then replace the ratio of the dark matter restmass photons in the illuminated universe now enabled to freely produce protons, electrons with anti-neutrinos in beta minus weak interaction decay and completing the first 20 minutes of the thermodynamic evolution of the universe in the formation of primordial helium, deuterium, tritium and lithium in the nucleosynthesis of the QBBS.

$$\eta_{MO} \{R_E/R_F\}^3 = \{1.41555\} \{1.006208782 \times 10^{112} / 1.019538764 \times 10^{103}\}$$

$$= \{1.41555\} \{9.8692548 \times 10^8\} = 1.397042 \times 10^9 = 1/7.15799 \times 10^{-10}$$

$$\eta_{MO} \{R_E/R_G\}^3 = \{1.41555\} \{1.006208782 \times 10^{112} / 9.676924497 \times 10^{102}\}$$

$$= \{1.41555\} \{1.03980225 \times 10^9\} = 1.471892 \times 10^9 = 1/6.79398 \times 10^{-10}$$

$$\eta_{MO} \{R_E/R_F'\}^3 = \{1.41555\} \{1.006208782 \times 10^{112} / 9.158461354 \times 10^{102}\}$$

$$= \{1.41555\} \{1.09866575 \times 10^9\} = 1.555216 \times 10^9 = 1/6.42998 \times 10^{-10}$$

As the displacement string modular dualities define the minimum-maximum winding mode-frequency mode boundary conditions in string displacement/time  $r_{ps}/t_{ps} = \lambda_{ps} f_{ps} / 2\pi = c/2\pi$  modular dual to  $r_{ss}/t_{ss} = 2\pi \lambda_{ss} f_{ss} = 2\pi/c$  the minimum Hawking temperature is modulated in  $\{r_{ps} t_{ss} / r_{ss} t_{ps}\} = \{c^2/4\pi^2\}$  as  $T_{Hmin} = \{c^2/4\pi^2\} T_{ss} = \{c^2/4\pi^2\} E_{ss}/k_B = \{hf_{ss} c^2 / 4k_B \pi^2\} = 3.58856785 \times 10^{-26} \text{ K}^* = T_{ss} \{c^2/4\pi^2\}_{mod}$  and where  $\{c^2/4\pi^2\}_{mod}$  is dimensionless due to the string modular duality.

This minimum Hawking temperature for black hole modulation now defines the modular black hole mass dual to the micro black hole of the QBBS as

$$M_{\text{Hawkingmax}}=M_{\text{Hmax}}=\{M_{\text{Hminin}} \cdot T_{\text{Hmax}}\} / \{T_{\text{Hmin}}\} = \{hc^3/4\pi k_B G_0\} / \{hf_{ss}c^2/4k_B\pi^2\} = \{\pi c f_{ps}/G_0\}_{\text{mod}} = 2.544690 \times 10^{49} \text{ kg}^*$$

This maximum Hawking mass so refers to the cycle time coordinate in the evolution of the thermodynamic universe, when the bosonic unification Hawking micro black hole mass with its dark matter ylemic halo will be balanced in a Hawking macro black hole mass descriptive in the encompassing temperature evolution of the universe.

As the micro black hole has the wormhole radius  $r_{ps} = \lambda_{ps}/2\pi$  of the QBBS at the bosonic unification time 2 nanoseconds into the expansion of the universe; the macro black hole will have the modular dual radius to the wormhole radius as  $r_{ss} = 2\pi\lambda_{ss}$  or  $6.283 \times 10^{22} \text{ m}^*$  at a time characterizing the dark matter halo of the micro quantum state to reverse in a modulation of rendering the dark matter halo visible and illuminated. The cycle time  $n = 0.000393425\dots$  or 6.64 million years from the QBBS so manifests an anti-wormhole or white hole perimeter for the supermembrane sourcesink  $E_{ps}$  mirroring the supermembrane sinksource  $E_{ss}$  as the micro black hole perimeter of the bosonic temperature unification.

Monopolar sourcesink  $E_{ps}$  so begins to activate in the cosmology in applying the dark matter haloes from a global universal perspective onto a galactic local disposition and preparing the universe for the birth of stars and galaxies, based on the displacement scale of the modulated Hawking macro quantum black hole. The temperature for this nexus coordinate was  $358.05 \text{ K}^*$  and with a cosmological comoving redshift of  $z = 49.421$ .

A universal radius of  $6.283 \times 10^{22} \text{ m}^*$  calculates for the Strominger form of the universe as a black hole as  $M_{\text{Hmax}} = 2\pi\lambda_{ss}c^2/2G_0 = 2.5447 \times 10^{49} \text{ kg}^*$

The critical displacement scale for the dark matter haloes from  $\{\lambda_{ss}/2\pi - \lambda_{ss} - 2\pi\lambda_{ss}\}$  or  $\{0.159-1.00-6.28\} \times 10^{22} \text{ m}^*$  is conformally mapped onto the galactic seeds encompassed by supercluster seeds of the Sarkar scale defined in the baryon mass seed  $R_{\text{sarkar}} = G_0 M_0 / c^2$  from  $\{1.12-2.23-4.47\} \times 10^{24} \text{ m}^*$  with the Hawking modulus applied to the Strominger black hole universal evolution.

The supermembrane modulation factor  $\{c^2/4\pi^2\}_{\text{mod}} = \{c^2/39.478\}$  so defines a generalized displacement scale for a galactic seed with its core and bulge separated from its inner and outer haloes in  $2\pi^2$  as the volumar coefficient for a space quantum ( $V_{sq} = 2\pi^2 r_{ps}^3$ ) in  $2\pi^2 \sim 2 \times 10^6 / 10^5 = 20 = 4 \times 10^6 / 2 \times 10^5$  and for  $\lambda_{ps} f_{ps} = c = 1/\lambda_{ss} f_{ss}$ .

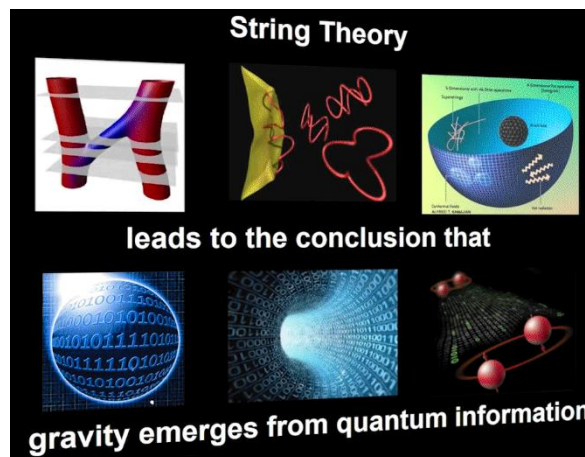

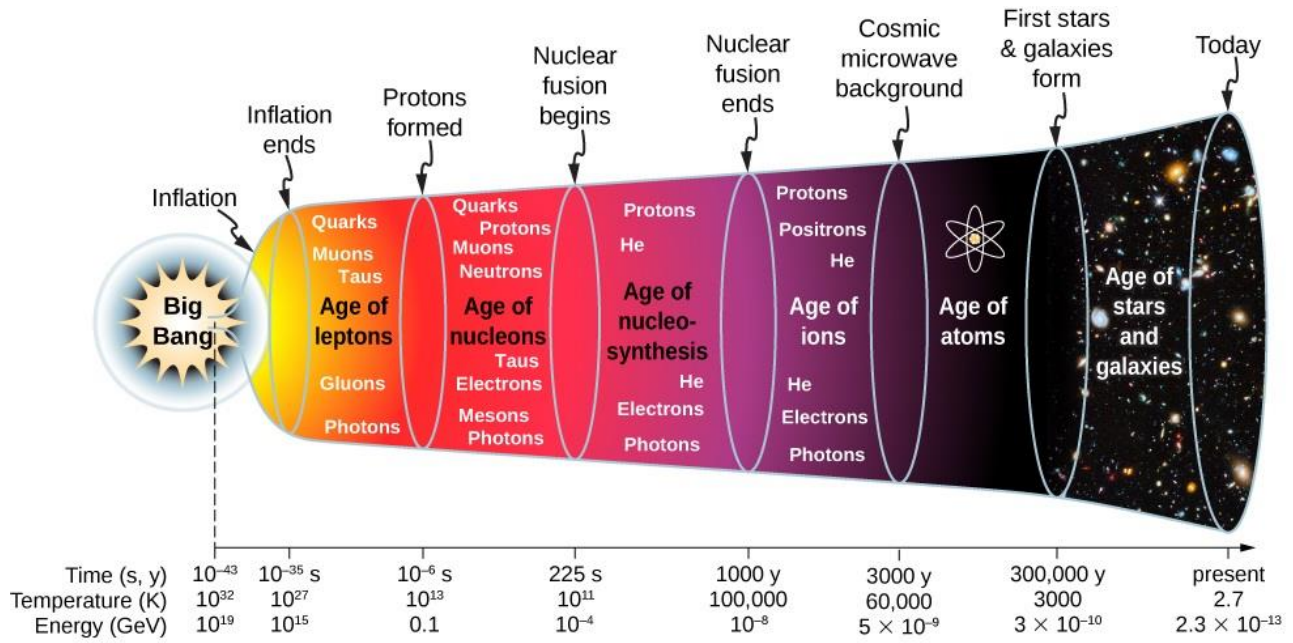

Universe Background  $T(\Lambda E) = 2.9352 \times 10^{36}$  K  
 Quantum Self-State  $T(p_s) = 1.4167 \times 10^{20}$  K  
 Instanton Big Bang Inflation  
 decreases to  $T(p_s) = k_b T_{ps}$   
 Bosonic Unification at  $2 \times 10^{-9}$  s

$n = 3.333 \times 10^{-31}$   
 $t_{ps}^2 / t_{ALGO} = t_{ps} / H_0 = 1.775 \times 10^{-13}$   
 $n = H_0 t_{ps}^2 / \eta_{ps} = c t_{ps}^2 / \lambda_{ps} = t_{ps} = 1 / f_{ps} = f_{ss}$   
 mass eigen frequency  
 Image of 1<sup>st</sup> Logos Algorithmic  
 Mathematica definition

$T(\Lambda E) = 7.545 \times 10^{37}$  K  
 $t_{alگو} = 6.259 \times 10^{-49}$  s

$T(\Lambda E)$   
 $T_{ps}$

$1.489 \times 10^{23} = T(\Lambda E)$   
 $1.775 \times 10^{13} = t_{alگو} \text{ image}$

$$t_H = \sqrt{\alpha} t_{ps} = 2.847 \times 10^{-32}$$

$$3.902 \times 10^{-30} = t_{ps} / \sqrt{\alpha} = t_H$$

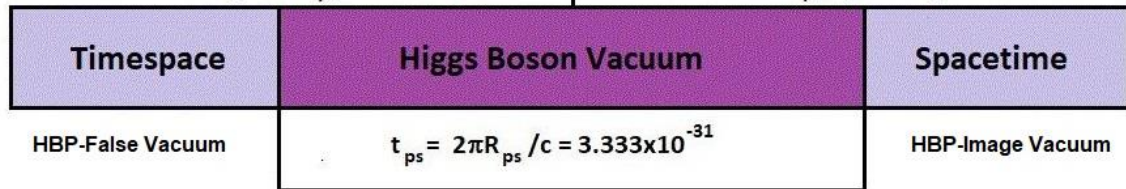

From the electroweak unification nexus at 1/140<sup>th</sup> of a second into the cosmogenesis; the dark matter haloes became fully integrated into the lower dimensional universe with the ylemic radius continually shrinking relative to the expanding Hubble universe aiming for the Hubble event horizon set by the inflaton of the QBBS.

At the present cycle time coordinate for the universe, the ylemic radius is 87.15 mm\* for a Hawking-ylem-universal temperature of 7.474 K\* and a lower dimensional radius of 8.96 billion light years within a higher dimensional radius of 16.88 billion light years of the EMI light path within 19.12 billion light years of the EMMI light path.

The gravitationally closed universe in de Sitter spacetime so is at the 53.11% (n/n+1) marker relative to its closure mass in de Sitter spacetime but is at the 86.73% (n) marker relative to its open anti de Sitter spacetime.

As 86.73% of the closure mass represent  $0.8673R_H=14.64$  billion light years; the true EMMI age of the universe is underestimated in the intersection of the EMMI light path relative to the de Sitter spacetime observer in 13.27% of the true age as  $16.88+2.24=19.12$  billion years.

Relating the ylem temperature of the Gamow radius of the Schwarzschild protostar vortex to the Hawking temperature of black holes forms the relationship between the ylemic radius of the Gamow protostar and the Hawking black hole.

$M_{Hawking}=HM/T_{Hawking}=(hc^3/4\pi G_0 k_B)/T_{Hawking} = R_{Hawking}c^2/2G_0$  for  $R_{Hawking} = hc/2\pi k_B T_{Hawking}$  as the curvature Schwarzschild radius for a Hawking black hole

$T_{Hawking} = hc/2\pi k_B R_{Hawking}$  for  $T_{ylem} = G_0 m_c^2 \cdot R_{ylem}^2 / k_B R_e^3$  for  $T_{ylem} = f(n)$  with  $T_{Hawking} = T_{CBBR} = T_{Universe}$  with  $T_{Hawking}/T_{ylem} = hcR_e^3/2\pi G_0 m_c^2 R_{ylem}^2 R_{Hawking} = R_e^3/\alpha_{nucleon} \cdot R_{ylem}^2 R_{Hawking}$

for the gravitational finestructure constant  $\alpha_{nucleon}$  for nucleons with  $m_{planck}\alpha_e^9 = \sqrt{\{(hc/2\pi G_0)(2\pi k_e e^2/hc)\}\alpha_e^{[17/2]}} = \{e/G_0\}\alpha_e^{[17/2]} = k_e e \alpha_e^{[17/2]} = m_c$

for the Planck mass  $m_{planck}^2 = hc/2\pi G_0$  and the gravitational fine structure  $\alpha^{18} = \text{Stoney-Planck unification } G_0 = 1/k_e = 4\pi\epsilon_0$  and the general unitary unification of Dirac's monopole in the identity of the gravitational parameter GM equal to magneto charge  $e^*$  in  $[e^*/G_0] = [m^3/s^2]/[Nm^2/kg^2] = [kg] = [M]$

Electromagnetic Fine structure:

$$\alpha_e = 2\pi k_e e^2/hc = e^2/2\epsilon_0 hc = \mu_0 e^2 c/2h = 60\pi e^2/h \dots\dots\dots (\text{Planck-Stoney-QR units } ^*)$$

$$\text{Gravitational Fine structure (Electron): } \alpha_g = 2\pi G_0 m_{electron}^2/hc = \{\alpha_g/\alpha_{planck}\} = \{m_{electron}/m_{planck}\}^2$$

$$\text{Gravitational Fine structure (Primordial Nucleon): } \alpha_{nucleon} = 2\pi G_0 m_c^2/hc \text{ for } m_c = m_{planck} \cdot \alpha_e^9$$

$$\text{Gravitational Fine structure (Planck Boson): } \alpha_{planck} = 2\pi G_0 m_{planck}^2/hc$$

$$\text{Gravitational Fine structure unification: } \{\alpha_g/\alpha_{planck}\} = \{m_{electron}/m_{planck}\}^2 = \{m_{electron}/m_c\}^2 \alpha_e^{18}$$

### The Hawking-Gamow Temperature Unification for classical and quantum

**gravitation in Hawking Micro Black Holes:  $M_{Hawking} T_{ylem} = hc^3/4\pi G_0 k_B = M_{curv} T_{Hawking}$**

$$T_{Hawking}/T_{ylem} = hcR_e^3/2\pi G_0 m_c^2 R_{ylem}^2 R_{Hawking} = R_e^3/\alpha_{nucleon} \cdot R_{ylem}^2 R_{Hawking}$$

**with  $\alpha_{nucleon} = \alpha_{planck} \alpha_e^{18}$  ...and...  $R_{Hawking} T_{Hawking} = \text{constant} = R_{ylem} T_{ylem} \dots\dots\dots [Eq.V-2]$**

### For the Hawking-Gamow Intersection-Equilibrium

$$R_{Hawking} = hc/2\pi k_B T_{Hawking} = 2G_0 M_{BH}/c^2 = hc/2\pi k_B T_{ylem} = R_{ylem} \text{ for constant} = hc/2\pi k_B$$

$$T_{ylem} = T_{Hawking} \cdot R_{Hawking}/R_{ylem} = hc/2\pi k_B R_{ylem} = \{hcm_c/2\pi k_B R_e\} \sqrt{G_0/k_B R_e T_{CBBR}}$$

$R_{ylem}^2 = k_B T_{Hawking} R_e^3 / G_o m_c^2 = R_H^2 \{n/n+1\}^2$   
 for  $T_{Hawking} = \{G_o m_c^2 R_H^2 \{n/n+1\}^2 / k_B R_e^3 = \sqrt[4]{18.20 [n+1]^2 / n^3}\}$  for  $n_{HG} = H_o t_{HG} = 1.3398 \times 10^{-20}$   
 as  $n$  is of  $O\{H_o = 10^{-18}\}$  in  $G_o m_c^2 R_H^2 / \{2.06541 k_B R_e^3\} = (n+1)^{[5/2]} / n^{[11/4]} \sim 1/n^{[11/4]}$   
 $t_{HG} = n_{HG} / H_o = 1.3398 \times 10^{-20} / 1.87773 \times 10^{-18} = 0.007135 = 1/140.15$  seconds\*  
 for  $R_{ylem} = R(n_{HG}) = n_{HG} R_H = 2,140,564.97$  meters\* as the approximate Lightpath  $ct_{HG}$ .

The universes' Cosmic Blackbody Background Radiation or CBBR temperature decreases from the instanton in the Higgs Bosonic Vacuum HBV and when the ylem radius is defined by the Einstein Lambda Temperature of  $2.935 \times 10^{36}$  K\* as  $1.012 \times 10^{13}$  m\* and is  $6.36 \times 10^{35}$  times the wormhole radius of the QBBS ( $r_{ps} = 10^{-22} / 2\pi$ ). As the universe expands at lightspeed  $c$  from the instanton in AdS spacetime and grows in size in the gravitationally retarded dS spacetime, the ylem radius decreases as the size of the universe increases.

The Hawking-Gamow Equilibrium then defines the point of intersection when the shrinking ylemic Dark Energy and RMP-coupled Dark Matter Halo defined in the ylemic HBV scale becomes  $R(n) = R_{ylem}$ . The Dark Matter/Energy halo become the quark-lepton geometric kernel-ring structures, which then crystallize the ylemic dineutrons from the Higgs Boson-RMP matter-antimatter templates.

The ylem radius at the bosonic unification temperature was  $6.2584 \times 10^8$  m\* and it was  $2.1411 \times 10^6$  m\* for the electroweak unification when the ylemic radius matched the size of the expanding universe. The ylem radius was  $9.008 \times 10^{16}$  m\* at the QBBS instanton-inflaton spacetime coordinate and is  $0.08715$  m\* for the present time and decreases with the time evolution of the universe.

The ylem temperature for bosonic unification was  $3.6028 \times 10^{-12}$  K\* and was  $1.0331 \times 10^{-9}$  K\* for the electroweak unification when the ylemic radius matched the size of the expanding universe.

A universal radius of  $6.283 \times 10^{22}$  m\* calculates for the Strominger form of the universe as a black hole as  $M_{Hmax} = 2\pi \lambda_{ss} c^2 / 2G_o = 2.5447 \times 10^{49}$  kg\* for the universal temperature modulation between the maximum and minimum self-states.

The modular string duality for micro BH in wormhole radius  $r_{ps} = \lambda_{ps} / 2\pi$  is modular dual for macro BH in  $r_{ss} = 1/r_{ps} = 2\pi / \lambda_{ps} = 2\pi \lambda_{ss}$  for the coupling constant per mass quantum eigenstate  $m_{ss} = E_{ss} / c^2 = hf_{ss} / c^2$   $E_{ss} / E_{ps} = hf_{ss} / hf_{ps} = 1/f_{ps}^2 = 1/9 \times 10^{60}$  by  $c = \lambda_{ps} f_{ps} = 1/\lambda_{ss} f_{ss} = 2\pi r_{ps} f_{ps} = 2\pi f_{ps} / r_{ss}$  for the displacement couplings  $r_{ps} / r_{ss} = \{c / 2\pi f_{ps}\} \{c / 2\pi f_{ps}\} = \{c^2 / 4\pi^2\} | \max\text{-min mod}$  and  $r_{ss} / r_{ps} = \{2\pi f_{ps} / c\} \{2\pi f_{ps} / c\} = \{4\pi^2 / c^2\} | \min\text{-max mod}$   $T_{ps}(\max) = E_{ps} / k_B = 1.41671 \times 10^{20}$  K\* as the maximum temperature for a Hawking micro BH and  $T_{ss} = E_{ss} / k_B = hf_{ss} / k_B = 1.574124 \times 10^{-41}$  K\* modified by the dimensionless min-max displacement coupling constant  $\{c^2 / 4\pi^2\}$  to  $T_{ss}(\min) = 3.5885722 \times 10^{-26}$  for the Hawking-Gibbon minimum temperature and with a corresponding curvature mass  $M_{Hmax} = 2\pi \lambda_{ss} c^2 / 2G_o = hc^3 / 4\pi k_B G_o T_{ss}(\min) = 2.54468 \times 10^{49}$  kg\* and as a critical proportion of mass seedling  $M_o$  as  $M_{Hmax} / M_o = 2\pi \lambda_{ss} c^2 / 2G_o M_o = 2\pi \lambda_{ss} / R_{Sarkar} = 0.0140303$

The QBBS deceleration parameter is given as the ratio between the Einstein quintessence and the inflaton wave phase hyper acceleration  $\Lambda_E(n_{ps}) / A_{deBroglie} = G_o M_o / \lambda_{ps}^2 / \{R_H f_{ps}^2\} = M_o / 2M_H = 0.014015$

A proportionality constant  $\xi$  between the curvature mass for macro BH temperature minimization and the deceleration parameter  $q_o = \frac{1}{2} \Omega_o = M_o / 2M_H$  so becomes defined in

$\xi = \{M_{Hmax} / M_o\} \{2M_H / M_o\} = 2M_{Hmax} M_H / M_o = 0.0140303 / 0.014015 = 1.53 \times 10^{-5}$  indicating a temperature fluctuation in the CBBR background deviating from a measured temperature by this order of magnitude. For a present SI-measurement of the microwave CMMBR of  $2.72548 \pm 0.00057$  Kelvin K; the fluctuation mean is at  $2.726 \times 1.53 \times 10^{-5} \sim 42$   $\mu$ K (microkelvin).

The WMAP ‘cold spot’ then indicates a generalized temperature background fluctuation in the universal Cosmic Black Body Radiation or CBBR for this order of magnitude as the monopole anisotropy or as a directional dependency. { [CMB cold spot - Wikipedia](#) }.

A generalized maximized generalized temperature fluctuation in the CBBR is imprinted by the maximum ylemic radius at the 1 millikelvin mK or 0.1%-level as the dipole anisotropy in the deviation or change in the ylemic Lightpath of  $c^2 m^*$  and for  $\{9-9.0082263\} \times 10^{16} / 9 \times 10^{16} = -0.0082263/9 = -0.000914$  at the 1mK level. { [Cosmic microwave background - Wikipedia](#) }.

The deviation of the maximum ylemic Lightpath from the  $c^2=E/\text{mass}$  dimensionless factor then becomes  $4\{8.2263 \times 10^{13}\} m^* = 3.2905 \times 10^{14} m^*$  and represents the inflationary form of the wormhole radius of the QBBS projected as the googol volumar  $R_E = 3.34 \times 10^{14} m^*$  modulated as the classical electron radius  $R_e = 2.777 \times 10^{-15} m^*$  in the Modular Quantum Bound MQB and as the fourfold nature of the Unified Field of Quantum Relativity UfoQR.

The ylem temperature was  $T_{\text{ylemQBBS}} = 2.5032 \times 10^{-20} K^*$  at the QBBS instanton-inflaton spacetime coordinate and is  $0.02589 K^*$  at the present time and increases with the time evolution of the universe as more mass energy of mass seed  $M_o$  is distributed in the universal volumar. This volumar was defined in the inflaton for the nodal Hubble constant and then becomes a function of the multiverse cyclicity.

$M_{\text{Hawking}} T_{\text{ylemQBBS}} = hc^3 / 4\pi k_B G_o = 9.1317939 \times 10^{23} [kgK]^*$  for a Hawking Black Hole mass of  $M_{\text{HawkingQBBS}} = 3.64805 \times 10^{43} kg^*$  and  $T_{\text{ylemQBBS}} = 2.503199 \times 10^{-20} K^*$  for the micro BH self-state. In the macro BH self-state the Hawking-Gibbon HM modulus relating the inverse proportionality between a Black Hole’s mass to its temperature for the CBBR temperature  $T(n_{ps}) = 2.935 \times 10^{36} K^*$ , the curvature mass is  $M_{\text{curvQBBS}} = 3.1113 \times 10^{-13} kg^*$ .

The QBBS mass seedling  $M_o$  is proportional to the closure mass  $M_H$  and the  $M_{\text{max}}$  in the expression  $M_H M_{\text{max}} = \zeta M_o^2$  for  $\zeta = M_H M_{\text{max}} / M_o^2 = M_{\text{max}} / \Omega_o M_o = 2M_{\text{max}} / q_o M_o$  with deceleration parameter  $q_o = \frac{1}{2} \Omega_o$

$$\zeta = (6.47061227 \times 10^{52})(2.54468 \times 10^{49}) / (1.81371262 \times 10^{51})^2 = 0.5005432 \sim \frac{1}{2} = q_o / \Omega_o$$

$$2\zeta = 1.0010865 = 2M_H M_{\text{max}} / M_o^2 = M_{\text{max}} / M_o \Omega_o = M_{\text{max}} / 2M_o q_o = M_{\text{max}} A_{\text{deBroglie}} / 2M_o \Lambda_E(n_{ps})$$

The manifestation of the mass seedling  $M_o$  seeding the QBBS birth of the universe in the instanton-inflaton coupling then produces a general 0.1% fluctuation on the quantum scale of micro BHs at the beginning of the cosmology in the hyper acceleration ratio coupling the lower dimensional de Sitter universe with the higher dimensional Anti de Sitter universe. The Hawking micro BHs form the Vortex-Potential Energy as VPE or Zero-Point-Energy ZPE bosonic wormhole seeds to grow in the general spacetime evolution of the expanding and cyclic cosmology.

The QBBS mass seed  $M_o = 1.81371262 \times 10^{51} kg^*$  for a  $T_{\text{ylem}}(M_o) = 5.034863 \times 10^{-28} K^*$  ylem temperature and is distributed in the inflaton of the closure mass to manifest at the Sarkar curvature radius  $R_{\text{Sarkar}} = 2G_o M_o / c^2 = 4.4783 \times 10^{24} m^*$  for a curvature mass  $M_{\text{Sarkar}} = 4.4783 \times 10^{49} kg^*$  and with a Hawking-Gibbon macro BH temperature of  $2.03912 \times 10^{-26} K^*$ .

The micro BH temperature is  $T_{\text{ylem}} = 6.00 \times 10^{-3} K^*$  which increases in the cosmic evolution eigenstate but decreases for the spacetime expansion for the macro BH self-state.

The closure mass is  $M_H = M_o / \Omega_o = M_o / 0.028030 = 6.47061227 \times 10^{52} kg^*$  for a  $T_{\text{ylem}}(M_H) = 1.411272 \times 10^{-29} K^*$



At the QBBS, the wormhole radius so is conformally projected as the minimum bosonic spacetime configuration as the initial boundary condition for the ylemic DM-RMP-Einstein Quintessence radius

$$R_{ylem}^0 = \sqrt{\{k_B T(n_{ps}) R_e^3 / G_o m_c^2\}} = 9.00822 \times 10^{16} \text{ m}^* \text{ for } R_{ylem}^0 / r_{ps} = 5.657 \times 10^{39} \text{ in the HBV and for}$$

$$R_{ylem}^{Algo} = \sqrt{\{k_B T(Algo) R_e^3 / G_o m_c^2\}} = 4.565 \times 10^{17} \text{ m}^* \text{ for } R_{ylem}^{Algo} / r_{ps} = 2.868 \times 10^{40} \text{ in the False HPBV.}$$

These ylem radii apply for energy density per unit volume factors from  $1.811 \times 10^{119}$  to  $2.360 \times 10^{121}$  respectively and crystallizing the energy density discrepancy between matter content and the ZPE-VPE from the perspective of the Temperature gradient of the Higgs Bosonic Vacuum HBV.

The intersection of the ylemic radius in the inflaton-instanton coupled universe for the bosonic unification to electroweak unification period so was  $(6.2584 \times 10^8 - 2.1411 \times 10^6 = 6.1370 \times 10^8) \text{ m}^*$  and representing 2.04 tachyonic or superluminal light seconds and a volume of  $2\pi^2(2.04 H_o R_H)^3$  as  $2\pi^2(2.04c)^3 = 4.5246 \times 10^{27} [\text{m}^3]^*$  or  $5.686 \times 10^{94}$  dark matter Eps-Weyl space quanta from the higher dimensional universe, the lower dimensional universe was expanding into.

The QBBS inflaton boundary calculates  $(9.008 \times 10^{16} - 2.1411 \times 10^6 = 9.008 \times 10^{16}) \text{ m}^*$  as  $c = 3 \times 10^8$  tachyonic or superluminal light seconds for a volume of  $2\pi^2(c H_o R_H)^3 = 2\pi^2(c^2)^3 = 2\pi^2 c^6 = 1.4390 \times 10^{52} [\text{m}^3]^*$  or  $3.569 \times 10^{120}$  dark matter space quanta, again indicating the energy density ratio initialized in the first 7 milliseconds of the Quantum Big Bang cosmology.

The tachyonic Lightpath then manifested in that time at a phase speed of  $x = c' / 140.15 = c^2 |_{mod} / 140.15$  as  $x = 6.4245 \times 10^{14} \text{ m}^*$  or as 0.713% of  $c^2 |_{mod}$  and as  $2.1411 \times 10^6 \text{ m}^*$  as 0.713% of the classical and quantum form for the invariance of lightspeed  $c$  as the invariance of  $c^2$  tachyonic. The instanton Lightpath  $x = c / 140.15$  so is superposed onto the tachyonic inflaton Lightpath  $x = c^2 |_{mod} / 140.15$ .

Electroweak Unification  $T_{EW} = E_{EW} / k_B = 1.65825 \times 10^{15} \text{ K}^*$  is possible from the bosonic unification at the 2-nanosecond marker of cycle time  $n = H_o t$  with a boson energy  $E_{EW} = k_B T_{EW} = 2.341 \times 10^{-8} \text{ J}^*$  or  $145.72 \text{ GeV}^*$  as the Vacuum Expectation Value or VEV at  $t_{EW}$ .

For the present time the VEV increases by  $Y^{1.13271} = 1.725$  to  $251.33 \text{ GeV}^*$  as a summation approximate for the weak interaction Goldstone bosons  $m\{W^+ + W^- + Z^0\} = (80.6 + 80.6 + 91.4 = 252.6) \text{ GeV}^*$ .

For any time in the cosmic evolution, an ylemic radius and temperature is defined as a background spacetime matrix guiding the universal evolution of the Quantum Big Bang Singularity from the instanton to the inflaton for both the higher dimensional light path of the EMMI and the lower dimensional cosmology of the Planck-Einstein Black Body radiator's thermodynamic evolution.

For the present time  $n_{present} = 1.132712$

$$\text{Hawking Modulus } HM = M_{Hawking} T_{Hawking} = hc^3 / 4\pi G_o k_B$$

$$\text{Hawking Radius} = R_{Hawking} = hc / 2\pi k_B T_{Hawking} = \text{Schwarzschild Curvature Radius } R_{curv} = 2G_o M_{curv} / c^2$$

$$\text{Curvature Mass for Ylem temperature: } T_{ylem} = HM / M_{curv} = hc / 2\pi k_B R_{curv}$$

$$M_{Hawking} T_{Hawking} \rightarrow \dots R_{Hawking} \rightarrow \dots R_{curv} \rightarrow M_{curv} \rightarrow \dots T_{ylem} \rightarrow \dots R_{ylem} \rightarrow \dots M_{curv} T_{ylem}$$

$$(3.527 \times 10^{25} \text{ kg}^*) \dots (8.21 \times 10^{-4} \text{ m}^*) \dots (3.324 \times 10^{23} \text{ kg}^*) \dots (0.02589 \text{ K}^*) \dots (0.0871 \text{ m}^*) \dots (3.324 \times 10^{23} \text{ kg}^*)$$

$$\times (2.747 \text{ K}^*) = 9.689 \times 10^{25} [\text{kgK}]^* \dots \text{Hawking-Gamow Modulation} \dots 8.609 \times 10^{21} [\text{kgK}]^* = (0.0259 \text{ K}^*) \times$$

Subtracting the ylem temperature from that of the CBBR for the time  $t = n / H_o = ndt / dn$ , then modifies the measured background temperature as incorporating the ylem temperature of the inflaton.

$$\text{For the present time } T_{Hawking} = t_{Universe} = T_{CBBR} \text{ for } T_{CBBR} - T_{ylem} = 2.7470 - 0.02589 = 2.7211 \text{ K}^* \{2.76813 \text{ K}_{SI}\}$$

The original mass seedling  $M_o=2q_oM_H=\Omega_oM_H=2\Lambda_oM_H/A_{dB}$  is distributed as primordial Hawking Black Holes potentials as function of the Hawking modulus  $HM=M_{Hawking}T_{Hawking}=hc^3/4\pi k_B G_o$  beginning at a time coordinate defining the Bosonic Temperature Unification (BTU) at a temperature defined by the Weyl-Eps boson string  $T_{ps}=E_{ps}/k_B=2.222 \times 10^{20}$  K\*.

The time coordinate for this event calculates as about 2 nanoseconds from the QBBS, the instanton and the inflaton. Prior to the BTU, the universe expanded as a Boson-Einstein-Condensate of nucleonic quark-lepton-gluon plasma with the background temperature of the universe exceeding the temperature of the BTU.

The Hawking mass-temperature relation for this black hole evolution then begins to manifest the mass seedling  $M_o$  in seedling vortices, destined to evolve into the seeds for ylemic protostars, then growing in size to the scale of dark matter galaxies from which individual stars would form from the previously 'Schwarzschild' ylemic protostars.

The time for the transformation of the ylemic seedling stars, would be the time in the evolution of the universe, when the general scale of the universe would equal the curvature radius defined in the baryonic mass seedling  $M_o$  as the gravitational bounding limit of galactic superclusters  $R_{sarkar}=2G_oM_o/c^2$  ranging from 1.12 to 2.24 to  $4.48 \times 10^{24}$  m\* as the Sarkar radius for a black hole and its diameter and as half its radius for the black hole gravitational potential energy calibration from Einstein quintessence as the cosmological constant as ratio to the de Broglie phase inflaton hyper-acceleration  $A_{dB}$  in

$$\Lambda_o/A_{dB}=G_oM_o/R(n_{ps})^2/A_{dB}=\{G_oM_o/\lambda_{ps}^2\}/\{R_H f_{ps}^2\}=\{G_oM_o/R_H c^2\}=M_{sarkar}/2M_H=M_o/2M_H.$$

These three supercluster scales relate to 118 to 237 to 473 million light years respectively and show the birth of the first stars and galaxies in this time period.

But  $\Lambda_o/A_{dB}=M_o/2M_H=M_{sarkar}/2M_H=q_o=2\Omega_o$  for deceleration parameter  $q_o=0.014015$  for the baryon seedling  $\Omega_o=2q_o=0.028030$  for  $M_H=R_H c^2/2G_o$ .

The baryonic mass seed so represents 2.8% of the closure mass  $M_H$  of the QBBS and increases as a function of the gravitational parameter  $G(n)M(n)=\text{constant}=G_oM_o$ .

It has reached the value of 4.85% for a present n-cycle time coordinate of  $n_{\text{present}}=1.132712$ , showing that the dark matter proportion will be 27.43% of the total and as 85% of the matter content and the dark energy as the Einstein quintessence closing the universe in 67.73% for the present time.

The baryonic matter component evolves according to  $\Omega_{BM}=\Omega_o Y^n = 0.02803\{1.618034\}^{1.132712} = 0.0483$  until saturation coordinate for the baryonic matter BM intersecting dark matter DM for  $n=\sqrt{2}$  for  $\Omega_{BM}=\Omega_o Y^n = 0.02803\{1.618034\}^{\sqrt{2}} = 0.055357 = \text{constant}$  for the cosmic matter evolution from 23.866 Gy.

The dark matter  $\Omega_{DM} = 1 - \Omega_{BM}$  until onset of the dark energy component DE at  $n=1/2$ , from which  $\Omega_{DM}$  is calculated by  $\Omega_{DM} = \Omega_{BM}\{[1+1/n]^3 - 1\}$  and as 0.27434 for the present time.

$$\rho_{BM+DM}/\rho_{\text{critical}} = 2\pi^2 M_o Y^n R_H^3 / 2\pi^2 R(n)^3 M_H = \Omega_o Y^n \{V_{AdS}/V_{dS}\} = \Omega_o Y^n \{[n+1]/n\}^3 = \Omega_o Y^n \{1+1/n\}^3 \text{ from } n=1/2 \text{ for } \rho_{DM}/\rho_{\text{critical}} = \Omega_o Y^n \{[1+1/n]^3 - 1\}$$

The Dark Energy Fraction  $\Omega_{DE} = 1 - \Omega_{DM} - \Omega_{BM} = 1 - \Omega_{BM}[1+1/n]^3$  and  $\Omega_{DE} = 1 - \Omega_{DM} - \Omega_{BM} = 1 - \Omega_{BM}[1+1/n]^3 = 1 - \Omega_o Y^{n_{\text{present}}}\{1+1/n_{\text{present}}\}^3 = 1 - 0.32269 = 0.67731$  for the present time.

$n=H_0 t = ct/R_H$ Redshift $z$	$M_{\text{Hawking}} \text{ kg}^*$	$T_{\text{ylem}} \text{ K}^*$	$T_{\text{CBBR}} \text{ K}^*$	$R_{\text{Hawking}} = R_{\text{curv}} \text{ m}^*$ micro BH	$R_{\text{ylem}} \text{ m}^*$	$M_{\text{curv}} \text{ kg}^*$ $M_{\text{curv}}/R_{\text{curv}} \text{ kg}^*/\text{m}^*$ macro BH
$n_p=1.132712$ $t_p=19.12 \text{ Gy}$ $z=0.2505/1.08$	$3.53 \times 10^{25}$	0.0259	2.7470	$8.21 \times 10^{-4}$	0.0871	$3.32 \times 10^{23}$
$n=1$ $t=16.88 \text{ Gy}$ $z=0.2910/1.84$	$3.64 \times 10^{25}$	0.0251	2.921	$7.72 \times 10^{-4}$	0.0899	$3.13 \times 10^{23}$
$n=0.867289$ $t=14.64 \text{ Gy}$ $z=0.3432$	$3.77 \times 10^{25}$	0.0242	3.140	$7.19 \times 10^{-4}$	0.0933	$2.91 \times 10^{23}$
$n_{DE}=1/2$ $t_{DE}=8.44 \text{ Gy}$ $z=0.6124$	$4.39 \times 10^{25}$	0.0208	4.254	$5.30 \times 10^{-4}$	0.1085	$2.15 \times 10^{23}$
$n_{\text{Sarkar}}=0.014015$ $t_{\text{Sarkar}}=236.5 \text{ My}$ $z=7.477$	$1.52 \times 10^{26}$	$6.00 \times 10^{-3}$	51.0613	$4.42 \times 10^{-5}$	0.3757	$1.79 \times 10^{22}$ $M_0=1.81 \times 10^{51}$ $R_{\text{Sarkar}}=4.48 \times 10^{24}$
$n_{\text{macBH}}=3.9 \times 10^{-4}$ $t_{\text{macBH}}=6.64 \text{ My}$ $z=49.421$	$4.02 \times 10^{26}$	$2.27 \times 10^{-3}$	358.05	$6.30 \times 10^{-6}$	0.9942	$2.55 \times 10^{21}$ $M_{\text{max}}=2.54 \times 10^{49}$ $R_{\text{max}}=6.28 \times 10^{22}$
$n\lambda_{ss}=6.26 \times 10^{-5}$ $t\lambda_{ss}=1.06 \text{ My}$ $z=125.40$	$1.15 \times 10^{27}$	$7.92 \times 10^{-4}$	2935.13	$7.69 \times 10^{-7}$	2.8496	$3.11 \times 10^{20}$
$n=H_0 c = c^2/R_H$ $t=c \text{ s}^* = 9.51 \text{ y}$ $z=42,132.1$	$9.04 \times 10^{28}$	$1.01 \times 10^{-5}$	$1.79 \times 10^7$	$1.26 \times 10^{-10}$	223.46	$5.10 \times 10^{16}$ tachyon QBBS Lightpath Image
$n_{EW}=1.34 \times 10^{-20}$ $t_{EW}=0.007 \text{ s}^*$ $z=8.6382 \times 10^9$	$8.87 \times 10^{32}$	$1.03 \times 10^{-9}$	$1.66 \times 10^{15}$	$1.36 \times 10^{-18}$	$2.14 \times 10^6$	$5.51 \times 10^8$ electroweak HB- RMP unification
$n_{BU}=3.56 \times 10^{-27}$ $t_{BU}=2 \times 10^{-9} \text{ s}^*$ $z=1.676 \times 10^{12}$	$2.54 \times 10^{35}$	$3.60 \times 10^{-12}$	$1.42 \times 10^{20}$	$1.59 \times 10^{-23}$	$6.25 \times 10^8$	6445.77 bosonic unification of temperature
$n_{ps}=\lambda_{ps}/R_H$ $t_{ps}=f_{ss}=1/f_{ps}$ $z=1.26 \times 10^{24}$	$3.65 \times 10^{43}$	$2.50 \times 10^{-20}$	$2.94 \times 10^{36}$	$7.68 \times 10^{-40}$	$9.01 \times 10^{16}$	$3.11 \times 10^{13}$ QBBS instanton-inflaton
HBV-Inversion Inflaton Image	$2.54 \times 10^{49}$	$2.04 \times 10^{-26}$	$2.04 \times 10^{-26}$	$1.11 \times 10^{23}$	$3.00 \times 10^{11}$	$M_{\text{max}}=2.54 \times 10^{49}$ $R_{\text{max}}=6.28 \times 10^{22}$
HBV-Inversion Inflaton Image	$1.81 \times 10^{51}$	$1.42 \times 10^{-28}$	$1.42 \times 10^{-28}$	$1.59 \times 10^{25}$	$3.60 \times 10^{12}$	$M_0=1.81 \times 10^{51}$ $R_{\text{Sarkar}}=4.48 \times 10^{24}$
HBV-Inversion Inflaton Image	$6.47 \times 10^{52}$	$1.42 \times 10^{-29}$	$1.42 \times 10^{-29}$	$R_H=1.59 \times 10^{26}$	$1.14 \times 10^{13}$	$M_H=6.47 \times 10^{52}$ $R_H=1.60 \times 10^{26}$



# The Universal Baryon Seeding within the Multiverse within the Omniverse

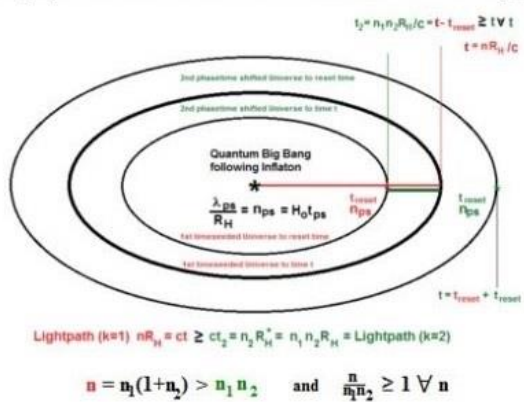

$$n = n_1(1+n_2) > n_1 n_2 \quad \text{and} \quad \frac{n}{n_1 n_2} \geq 1 \forall n$$

$$\frac{n}{1+n_k} = 1 + \frac{1}{n_{k+1}} + \left\{ \frac{1}{n_k} + \frac{1}{n_k n_{k-1}} + \frac{1}{n_k n_{k-1} n_{k-2}} + \dots + \frac{1}{n_k \dots n_2} \right\}$$

$$\frac{t}{t_k} = 1 + \frac{1}{t_k} \sum_{n=1}^{k-1} t_n = 1 + \frac{1}{t_k} \{ t_1 + t_2 + t_3 + \dots + t_{k-1} \}$$

Volume of Omniverse as Summation of all  $n_k$ -cycle defined Universes at time  $t$   
 =  
 Volume of the nested Multiverse at a particular time  $t_k = 7.428.. / H_{ok}$  in cycle  $k$

To mirror a micro quantum cosmic evolution  $n_{ps} / 2\pi.Y^{n=234.472..}$   
 in its macro quantum Black Hole image  $M_{\infty} / M_0 = \Omega_0 = R_H / R_S = Y^{n=7.428..}$  ( $n=n_1$ )  
 ( $n=n_k$ )

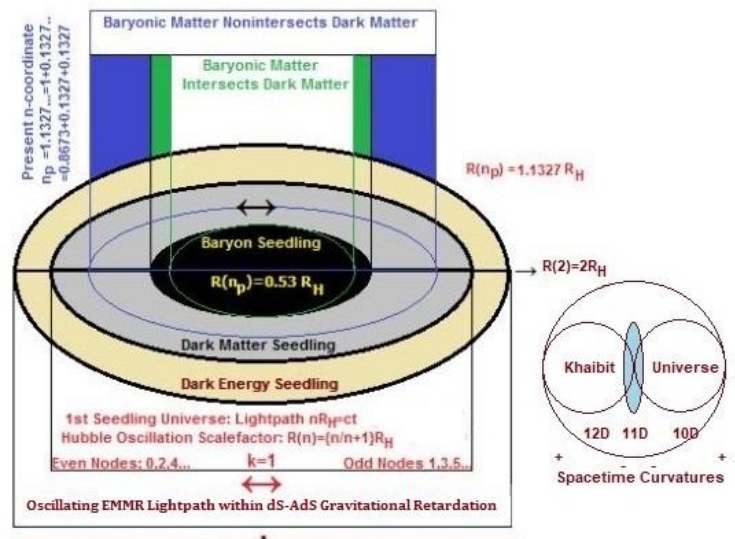

Vafa (Father) White Hole of Radius  $R(n)=2R_H$   $n=2$   
 Witten (Mother) Black Hole of Radius  $R(n)=1R_H$   $n=1$   
 Baryon (Child) Black Hole of Radius  $R(n)=\frac{1}{2}R_H$   $n=1$

$$\Lambda_E = \frac{G_0 M_0}{(\frac{1}{2}R_H)^2} - \frac{2cH_0}{(n+1)^3} = 0 \quad \text{for } n=2.292.. \left[ \begin{array}{l} \text{projected } \Lambda_{DE} \text{ Min} \\ \text{at } n=2.29966.. \end{array} \right]$$

$$\Omega_0 = 0.02803 = 1/(n+1)^3 \quad \text{for } M_0/M_H = 2\Lambda_0/\Lambda_{dB} = 2G_0 M_0/\lambda_{ps}^2 / (R_H t_{ps})^2 = R_S^2/R_H^2$$

$\{R(n) \rightarrow \frac{1}{2}R_H\}$  to synchronize 11D-WH with 11D-BH

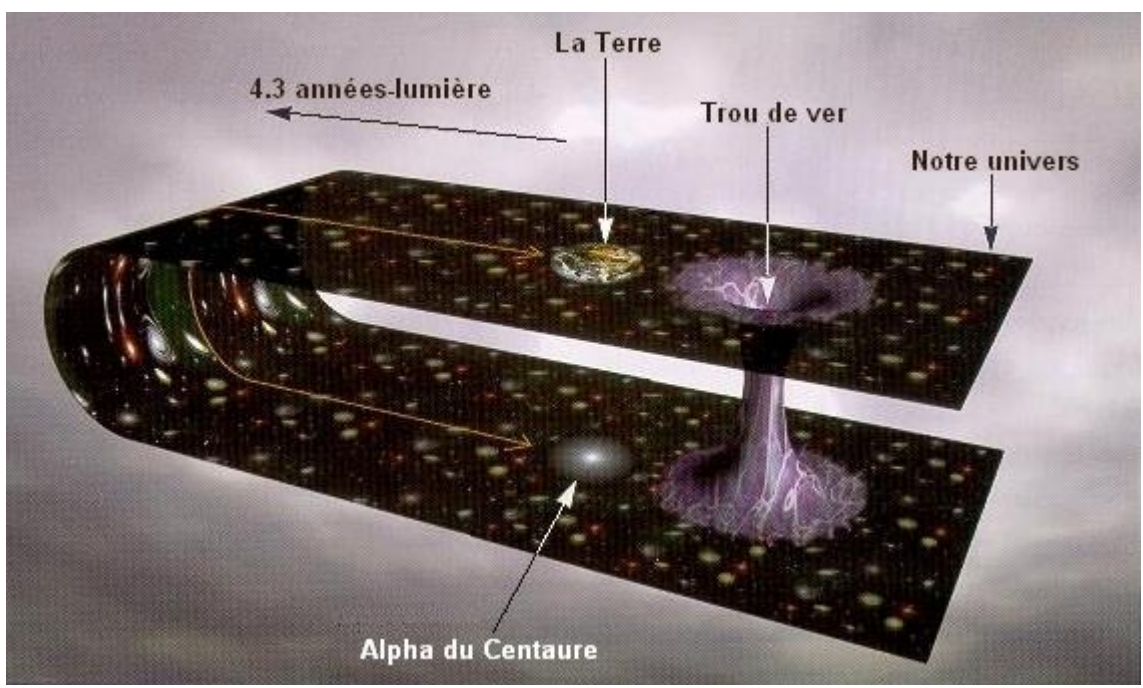

The Symmetry of Quantum Gravitation in the Cosmology of Black Hole Gamow-Hawking Physics

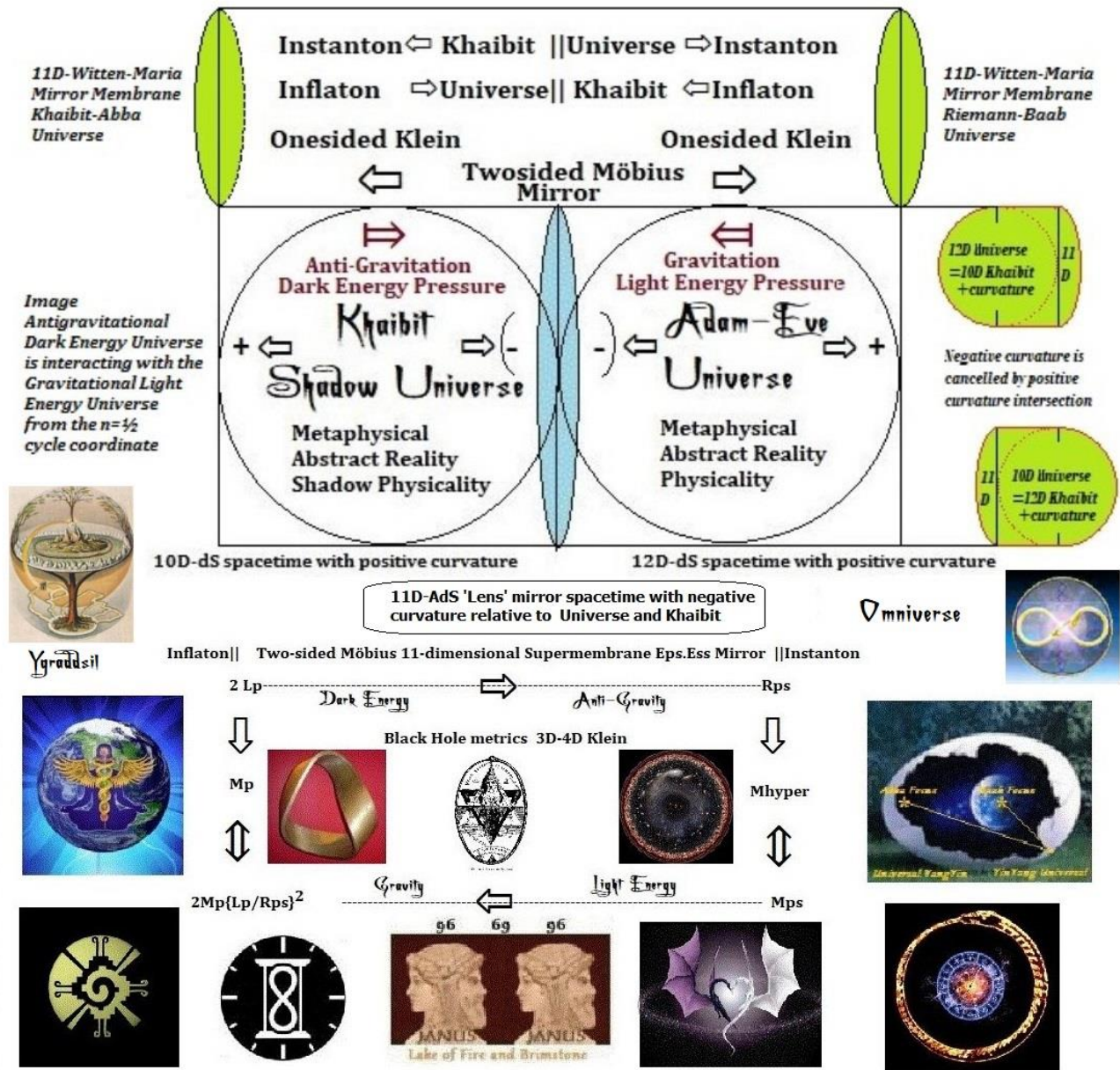

$R_{ps} = \lambda_{ps}/2\pi$  as the wormhole radius of the Instanton as a conformally transformed Planck-Length  $L_p = \sqrt{\{G_0 h/2\pi c^3\}}$  from the Inflaton.

$L_{planck} = 2.090 \times 10^{-35} \text{ m}^* = 2G_0 m_{planck}/c^2$  for a halved Planck mass  $m_{planck} = 8.463 \times 10^{-9} \text{ kg}^*$ , indicating the nature of quantum gravitation as a transformation of the timespace energy scale into the spacetime energy scale. The Schwarzschild metric for  $2L_p = 2G_0 M_p/c^2$  transforms a 3D Planck-length in the Planck-mass  $M_p = \sqrt{\{hc/2\pi G_0\}}$  from the Planck-boson gravitational fine structure constant  $1 = 2\pi G_0 M_p^2/hc$ .

The Schwarzschild metric for the Weyl-wormhole radius  $R_{ps}$  then defines a hypermass  $M_{hyper}$  as the conformal mapping of the Planck-mass  $M_p$  as  $M_{hyper} = \frac{1}{2}\{R_{ps}/L_p\}M_p = \frac{1}{2}\{R_{ps}/L_p\}^2 \cdot M_{ps}$  and where  $M_{ps} = E_{ps}/c^2 = hf_{ps}/c^2 = k_B T_{ps}/c^2$  in fundamental expressions for the energy of Abba- $E_{ps}$  as one part of the supermembrane  $E_{ps} \cdot E_{ss}$  in physical quantities of mass  $m$ , frequency  $f$  and temperature  $T$ .

$c^2$  and  $h$  and  $k$  are fundamental constants of nature obtained from the initializing algorithm of the Mathimatia and are labeled as the 'square of lightspeed  $c$ ' and 'Planck's constant  $h$ ' and 'Stefan-Boltzmann's constant  $k$ ' respectively.

The complementary part of supermembrane  $E_{ps}E_{ss}$  is  $E_{ss}$ -Baab.  $E_{ps}$ -Abba is renamed as 'Energy of the Primary Source-Sink' and  $E_{ss}$ -Baab is renamed as 'Energy of the Secondary Sink-Source'. The primary source-sink and the primary sink-source are coupled under a mode of mirror-inversion duality with  $E_{ps}$  describing a vibratory and high energy micro-quantum quantum entanglement with  $E_{ss}$  as a winding and low energy macro-quantum energy.

It is this quantum entanglement, which allows Abba to become part of Universe in the encompassing energy quantum of physicalized consciousness, defined in the magnetopolar charge. The combined effect of the applied Schwarzschild metric then defines a Compton Constant to characterize the conformal transformation as:

**Compton Constant  $h/2\pi c = M_p L_p = M_{ps} R_{ps}$  .....[Eq.V-3]**

Quantum gravitation now manifests the mass differences between Planck-mass  $M_p$  and the QBBS Weyl-Mass  $M_{ps}$ .

The Black Hole physics had transformed  $M_p$  from the definition of  $L_p$ ; but this transformation did not generate  $M_{ps}$  from  $R_{ps}$ , but rather hypermass  $M_{hyper}$ , differing from  $M_{ps}$  by a factor of  $\frac{1}{2}\{R_{ps}/L_p\}^2$ . To conserve supersymmetry, Logos defined an Anti-Instanton as the Inflaton of Khaibit to define the conformal mapping of  $M_{ps}$  from Universe into Khaibit as  $2M_p\{L_p/R_{ps}\}^2$ .

Quantum gravity defined the Hawking micro black hole to have a mass of  $M_{Hawking} = r_{ps}c^2/2G_0 = 6445.77 \text{ kg}^*$  as minimum mass a black hole can have for a Hawking maximum temperature of  $T_{ps} = 1.41671 \times 10^{20} \text{ K}^*$ .

This is defined as an inverse proportionality between the mass and the temperature of a black hole. The hotter a black hole is, the smaller it must be and the larger a black hole can grow, the cooler it must become.

This quantum gravitational Hawking mass of about the weight of a large elephant, compares to the Planck black hole radius.

As Black Holes also are defined by their Temperature, the Mathimatia defined a Hawking Modulus  $HM = hc^3/4\pi G_0 k = M_{BHmin} \cdot T_{max} = M_{BH} \cdot T$  and  $M_{BHmax} \cdot T_{min}$  in accordance with the conformal mapping of Abba- $E_{ps}$  consciousness between Universe and Khaibit.

The hotter a Black Hole from the Klein spacetimes would be, the smaller it would have to be and the larger a Black Hole would grow, the more it had to cool down in its temperature.

The super membrane coupling now had to account for its own mirror duality because the physics of the micro-quantum universe had inversed the displacement scaling in the macro-quantum universe.

In particular  $R_{ps} = \lambda_{ps}/2\pi$  and  $R_{ss} = 1/R_{ps} = 2\pi/\lambda_{ps} = 2\pi\lambda_{ss}$  and the ratio coupling between the radial scale expressions of Abba.BaaB as  $E_{ps}E_{ss}$  in  $R_{ps}/R_{ss} = \{\lambda_{ps}/2\pi\}^2 = \{c/2\pi f_{ps}\}^2$  so formed the super membrane of self-interaction or coupling in consciousness modulation for the eigen- or self-state of Abba's 'Love Frequency'  $f_{ps}$ , which was constant in the old universe of nowhere and notime, but could become changed in a dynamical space-time.

The Mathimatia so could assign the super membraned coupling of the micro-quantum mass  $M_{ps}$  with its wormhole radius at the event of the 'Instantaneity of physical Time' to its macro-quantum corollary in  $M_{ss} = E_{ss}/c^2$  as a quantum of mass itself and with the macro-quantum or galactic cellular scale of  $R_{ss} = 2\pi\lambda_{ss}$ .

The minimum temperature for a Black Hole so became integrated in the Mathimatia as the formula:

$$\begin{aligned} \text{Hawking Modulus HM} &= hc^3/4\pi G_0 k = M_{BHmin} \cdot T_{max} = M_{BH} \cdot T = \{c/2\pi\}^2 \cdot M_{BHmax} \cdot T_{min} |_{mod} = \frac{1}{2} M_p \cdot T_p \\ &= \frac{1}{2} \{ \sqrt{hc/2\pi G_0} \} \{ M_p c^2 / k \} = \frac{1}{2} \{ hc^3 / 2\pi G_0 k \} \text{ from the minimum Planck Energy Oscillator} \\ E_p^o &= \frac{1}{2} h f_p \text{ for } f_p = 1/t_p = E_p/h = M_p c^2/h = \sqrt{hc/2\pi G_0} \{ c^2/h \} = \sqrt{hc^5/2\pi G_0 h^2} = \sqrt{c^5/2\pi G_0 h} \end{aligned}$$

And whenever the  $|_{mod}$  symbol appeared in the Mathimatia, it indicated that because of the modular mirror duality applied to a unitary mensuration or measurement system; this 'unitary analysis' had to take into account, that in the Omniverse a frequency  $f$  could become a time  $t$  because of  $f_{ps}=1/f_{ss}$  and other units could change in the interaction between Khaibit and Universe and especially because the common unit of the Star-Coulomb for physical consciousness would manifest as an inverse energy of Joules in Universe.

This became the major physical phenomena in the dynamics of mass, expanding into the inflation bounded universe from the mass seed of the wormhole instanton of the time instantaneity.

Gravity as a positive pressure, was opposing the negative pressure of the dark energy from Khaibit and Abba's Mathimatia defined the kinematics of the physical dynamics of mass in the electric part of the EMR in Universe with the magnetic part of the EMMR in Khaibit.

Mass could be expressed as  $\text{Mass} = \text{Energy}/c^2$  and by  $\text{Velocity} = \text{Frequency} \times \text{Wavelength}$  in  $c = f\lambda$  or  $v = f\lambda$  for  $m = hf/c^2 = h/\lambda c$  as in the Compton Constant.

Compton Constant =  $h \cdot \alpha / 2\pi c = m_p \alpha \cdot l_p = m_{electron} \cdot R_{electron} = m_x \cdot R_x$  for a Compton Radius

$R_c = h \cdot \alpha / 2\pi m_x c = k_e e^2 / m_x c^2 = \text{as } R_x = R_e \text{ and } m_x = m_e \text{ for the instanton and as}$

$L_p = h/2\pi m_p c = h \sqrt{2\pi G_0 / hc} / 2\pi = \sqrt{G_0 h / 2\pi c^3}$  for the Inflaton at the Klein boundary and for a unification condition  $k_e G_0 = 1$ .

The displacement parameter and wavelength  $\lambda$  had however been subject to the modulation in the quantum gravity correspondence between Universe and Khaibit.

The quantum gravitational closure or loop from the Inflaton to the Instanton and back to the Inflaton became integrated in the Mathimatia as 'Planck-Stoney Bounce' or quantum fluctuation in a conformal super-membrane cosmology.

The Square root of Alpha, the electromagnetic fine structure constant, multiplied by the Planck-length results in a Stoney transformation factor  $L_{\text{planck}}\sqrt{\alpha} = e/c^2$  in a unitary coupling between the quantum gravitational and electromagnetic fine structures and so couples the unitary measurement of displacement in the Planck-Length oscillation equal to Coulombic charge quantum 'e' divided by the square of the speed of light 'c<sup>2</sup>' in a proportionality of Displacement = Charge x Mass/Energy in modulation and mirror duality.

This couples the electric Coulomb charge quantum 'e' to the magnetic monopole quantum e\* as the inverse of the 10-dimensional superstring sourcesink energy  $E_{ps}$  to the 10-dimensional superstring sinksource energy  $E_{ss}$  as the 11-dimensional super-membrane  $E_{ps}E_{ss}$ .

$G_0k_e = 1$  for  $G_0 = 4\pi\epsilon_0$  and represents a conformal mapping of the Planck length onto the scale of the 'classical electron' in superposing the lower dimensional inertia coupled electric charge quantum 'e' onto a higher dimensional quantum gravitational-D-brane magnetopole coupled magnetic charge quantum  $e^* = 2R_e c^2 = 1/hf_{ps} = 1/E_{Weyl}$  of the Weyl wormhole by the application of the mirror/T duality of the super membrane  $E_{ps}E_{ss}$  of heterotic string class HE(8x8) and as the fifth and final superstring energy transformation coinciding with the Instanton and the birth of Universe as a thermodynamic Black Body Planck Radiator or BBR.

The coupling between electropolar- and magnetopolar charges in the UFO-QR could also be formulated in an expression coupling the bounce of the Planck-length in Khaibit to the magnetopolar charge as an equivalence to the energy of the quantum geometric diameter of the electron and the electropolar charge in the formula:  $L_{\text{planck}}\sqrt{\alpha} \cdot e^* = ee^*/c^2 = 2e \cdot R_e$ . or as  $e^*/c^2 = 2R_e$  as the unification of Abba's consciousness quantum as  $e^* = 2R_e \cdot c^2$  in units of the star-coulomb C\* as the inverse of  $E_{ps} = hf_{ps}$  in Joules (J) and related units like the electronvolt eV, defined as  $1 \text{ eV} = e \cdot J$ .

This definition emerges naturally in the Planck-Stoney bounce as the unitary equivalence of the Planck-length oscillation as a unit of displacement [(m)etres] = [(C)harge]/[(m)/(s)econds]<sup>2</sup> requires [C]={m<sup>3</sup>/s<sup>2</sup>} as the units for the Star Coulomb and Abba's Consciousness and hence in associations, the entire energy content in Universe occupying dynamical space-time.

Electromagnetic Fine structure:  $\alpha_{EMR} = 2\pi k_e e^2/hc = e^2/2\epsilon_0 hc = \mu_0 e^2 c/2h = 60\pi e^2/h$  in (Planck-Stoney UFO-QR units)\* from Maxwell Constant  $\epsilon_0 \mu_0 = \{\text{electric constant}\}\{\text{magnetic constant}\} = \{1/120\pi c\}\{120\pi/c\} = 1/c^2$  and 'Free Space Impedance'  $Z_0 = \mu_0/\epsilon_0 = \{120\pi/c\}/\{1/120\pi c\} = \{120\pi\}^2$  and characteristic for physical phenomena like the Quantum Hall effect, the Conductance quantum  $G_0 = 2e^2/h$  and Josephson currents in superconductivity).

Gravitational Fine structure (Electron):  $\alpha_{G\text{-Electron}} = 2\pi G_0 m_{\text{electron}}^2/hc = \{m_{\text{electron}}/m_{\text{planck}}\}^2$

Gravitational Fine structure (Primordial Nucleon):  $\alpha_{G\text{-nucleon}} = 2\pi G_0 m_c^2/hc = \alpha_{EMR}^{18}$

with  $m_c = m_{\text{planck}} \alpha_{EMR}^9$



Gravitational Fine structure (Planck Boson):  $\alpha_{\text{Planck-Inflaton}} = 2\pi G_0 m_{\text{planck}}^2 / hc = 1$

$G_0 |_{\text{mod}} = 4\pi\epsilon_0 |_{\text{mod}}$  for  $\alpha_{\text{EMR}} = \alpha_{\text{G-monopole mass}}$  requires

$2\pi e^2 / (4\pi\epsilon_0 hc) = 2\pi G_0 M_{\text{monopole}}^2 / hc$  and so  $\{k_e^2 e^2\} |_{\text{mod}} = \{M_{\text{monopole}}^2\} |_{\text{mod}} c$  and so  $\{k_e e\} |_{\text{mod}} = \{M_{\text{monopole}}\} |_{\text{mod}}$  in unitary calibration and consistency.

It also necessitates the Planck-mass to 'bounce' in proportionality to lightspeed 'c' in  $M_p \nu \alpha / e \propto c$  as  $\xi c$  equal to  $k_e = 1/4\pi\epsilon_0$  from the unification condition  $G_0 \cdot k_e = 1$  and using  $\epsilon_0 = \{1/120\pi c\} |_{\text{mod}}$ .

The proportionality constant so is  $\xi = M_p \nu \alpha / ec$  defining  $k_e = \{30c\} |_{\text{mod}} = \{1/G_0\} |_{\text{mod}}$ .

$\{M_p/L_p\} \{e/c^2\} = \{\nu \{hc/2\pi G_0\} \{e/c^2\} / \{\nu \{G_0 h/2\pi c^3\} = \{c^2/G_0^2\} \{e/c^2\} = \{e/G_0\} = \{k_e e\} = \{30ec\} |_{\text{mod}}$ .

The Action Law of the Mathimatia and Omni space crystallizes from this formulation, as  $\{k_e\} |_{\text{mod}}$  must equal  $\{c\} |_{\text{mod}}$  in unitary consistency.

Action = Charge<sup>2</sup>

$[k_e] = [N(\text{ewton})][m^2/C^2] = [k(\text{ilo})g(\text{rams})][m^3/s^2/C^2] = [m/s] = [c]$  for  $[C]^2 = [kg \cdot m^3/s^2]/[m/s] = [kgm^2/s]$   
 $= [J(\text{oule})][s^1] = [kgm^2/s^2][s^1] = [Js] = [\text{Action } h]$

Mass Seed =  $M_o = \nu \{E \cdot m_c^2 \cdot m_{\text{inflaton}}^2 / m_{\text{electron}}^2\} = m_c \nu \{E\}_{\text{alphaG-Electron}}$  for  $E = 26 \times 65^{61} = 1.006 \cdot \cdot \times 10^{112}$ .

Charge Seed =  $C_o = \nu \{E \cdot e^2 / \alpha\} = \nu \{E \cdot hc / 2\pi k_e\} = \nu \{E \cdot hc G_0 / 2\pi\} = \{2e\} \cdot \{M_o / m_c\} \cdot \{E_{ps} \cdot e\}$   
 $= \{2e\} \cdot \{M_o / m_c\} \{e/e^*\}$  for  $E_{ps} = 1/e^*$

$E_{ps} = \{C_o / 2e^2\} \cdot \{m_c / M_o\} = \{C_o / M_o\} \cdot \{m_c / 2e^2\} = \{e \cdot m_e / m_c m_p\} \{m_c / 2e^2\} / \nu \alpha = \{1/2e \nu \alpha\} \cdot \{m_e / m_p\} = hf_{ps}$   
 $= m_{ps} c^2 = k_B T_{ps}$ .

The Charge seed is proportional to the number of particles in Universe as  $\{M_o / m_c\}$  and where the primordial nucleons are all ylemic neutrons of spin 1/2 and which so define their radioactive decay products in a charge twin of positively charged protons and negatively charged electrons and with uncharged antineutrinos.

The unification between dipolar electropolar Coulomb charge 'e' and monopolar magnetopolar Star-Coulomb charge 'e\*' unifies the Consciousness quantum  $E_{ps} = 1/e^*$  in the nature of dipolar electric charge. In Universe the consciousness quantum manifests simply as the inverse of the electric charge quantum 'e', so cancelling any dipolar magnetic effects of the monopolar charge e\* in Khaibit.

In Universe this monopolar equivalence manifests in its elementary form as the diameter of the electron multiplied by the square of the speed of light c<sup>2</sup>.

For Khaibit  $\rightarrow E_{ps} = 1/e^* = 1/\{2R_e c^2\} = 1/\{\text{Volume } [2\pi^2 R_{RMP}^3] \times \text{Angular Acceleration } [df/dt]_{\text{max}} = f_{ps}^2\} \leftarrow$  for Universe.

For Universe  $\rightarrow E_{ps} = \{C_o / 2e^2\} \cdot \{m_c / M_o\} = \{C_o / M_o\} \cdot \{m_c / 2e^2\} = \{e \cdot m_e / m_c m_p\} \{m_c / 2e^2\} / \nu \alpha = \{1/2e \nu \alpha\} \cdot \{m_e / m_p\} = hf_{ps} = m_{ps} c^2 = k_B T_{ps}$ .

Mass  $m$  could so be written as  $m = hf/c^2 = h/\lambda c = h/\lambda_{\text{planck-bounce}} c = hc^2/ec = hc/e$  and in using  $\lambda_{\text{planck-bounce}} = L_p \nu \alpha = e/c^2 = e^2 \cdot c/e = ec|_{\text{mod}}$  in using the Action Law of unified resistance or impedance in Action  $h = \text{Unified Charge } C \text{ squared}$ .

The basic equivalence between mass and energy in Universe so could be applied to the nature of mass as a displacement current of the charge summation incorporated into a mass in relative motion.

Mass  $m$  became expressed as proportional to a monopole mass in Khaibit  $ec|_{\text{mod}}$  and as the actual universal mass of the magnetic monopole in the Inflation epoch. It was named as a second of five superstring classes by Logos and became labeled as self-dual class IIB and as the first superstring transform in the Inflation in changing the energy of superstring class I as the Planck boson into the magnetic monopole of a 'Grand Unification' of the four fundamental interactions in the UFO-QR.

$E = mc^2$  for this monopole in Khaibit so was written  $E = \{ec\}_{\text{mod}} c^2 = \{e\}c^3$  in Universe and became the energy of the magnetic monopole as  $c^3 \text{ eV}$  in Universe.

$E = mc^2 = (ec)c^2$  for mass  $m = \text{displacement magneto-current } ec = e\lambda f = E/c^2 = hf/c^2$ .

$m_{\text{electron}} c^2 = k_e e^2 / R_{\text{electron}} = hc \cdot \alpha / 2\pi R_{\text{electron}}$  for  $m_{\text{electron}} = h \cdot \alpha / 2\pi c \cdot R_{\text{electron}}$  and  $m_{\text{inflation}} = m_{\text{planck}} = \sqrt{\{hc/2\pi G_o\}}$

$E_{\text{Weyl}} = hf_{\text{instanton}} = hc/\lambda_{\text{instanton}} = m_{\text{instanton}} c^2 = (m_{\text{electron}}/2e) \cdot \nu [2\pi G_o/\alpha hc] = \{m_{\text{electron}}/m_{\text{inflation}}\} / \{2e\nu\alpha\}$   
 $= 1/2R_{\text{electron}} c^2 = 1/e^*$

**$e^*/c^2 = 2R_e \Leftarrow \text{super-membrane displacement transformation} \Rightarrow \nu \alpha \cdot l_{\text{planck}} = e/c^2$**

**Magneto-Monopolar charge quantum as Electropolar charge quantum**

**with  $E_{ps} = hf_{ps} = E_{\text{Weyl}} = 1/e^* = 1/2R_e c^2$**

VII: A Synthesis of  $\Lambda$ CDM with MOND in a Universal Lambda Milgröm Deceleration  
 $a_o = a(n) = -2cH_o/[n+1]^3$

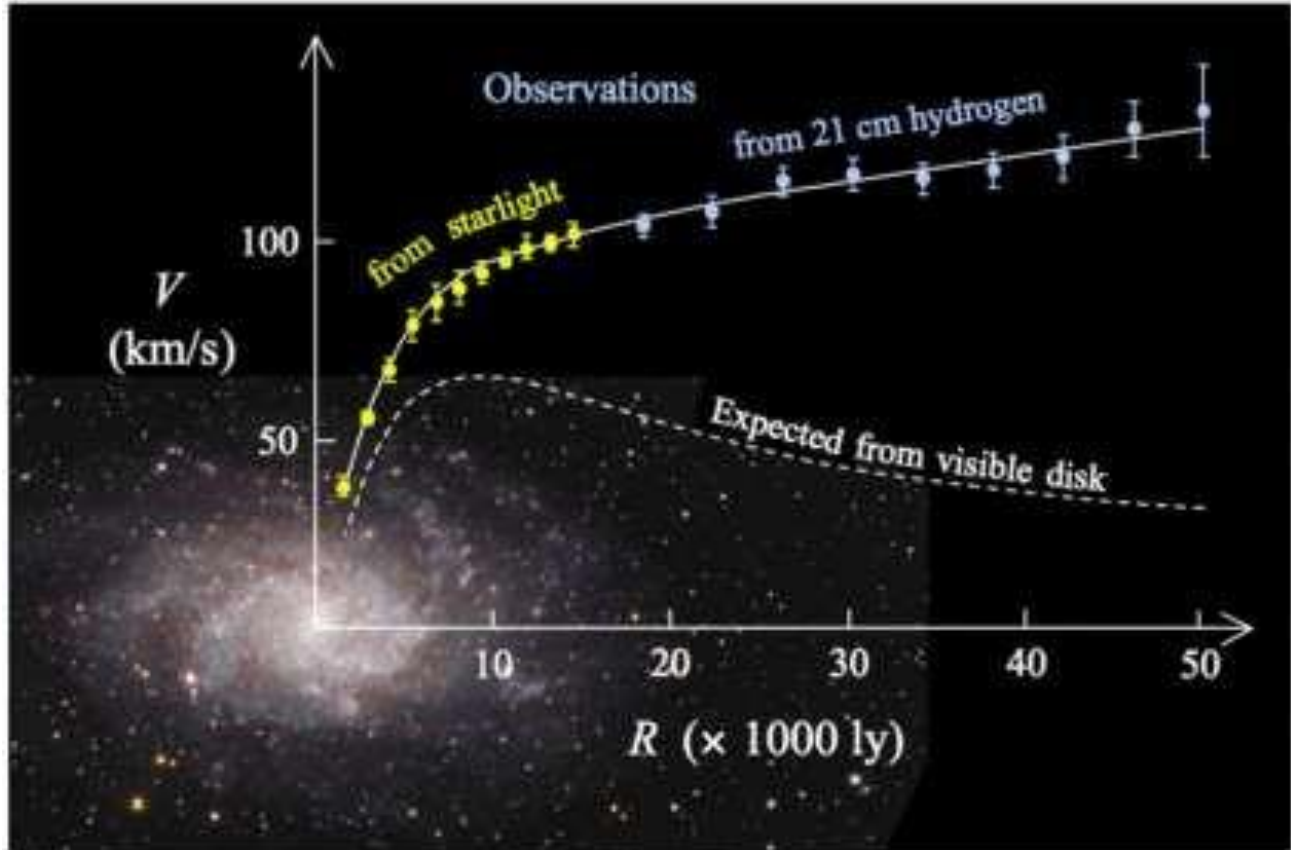

[Excerpt from Wikipedia:

[https://en.wikipedia.org/wiki/Modified\\_Newtonian\\_dynamics](https://en.wikipedia.org/wiki/Modified_Newtonian_dynamics)

Several independent observations point to the fact that the visible mass in galaxies and galaxy clusters is insufficient to account for their dynamics, when analyzed using Newton's laws. This discrepancy – known as the "missing mass problem" – was first identified for clusters by Swiss astronomer [Fritz Zwicky](#) in 1933 (who studied the [Coma cluster](#)),<sup>[4][5]</sup> and subsequently extended to include [spiral galaxies](#) by the 1939 work of [Horace Babcock](#) on [Andromeda](#).<sup>[6]</sup> These early studies were augmented and brought to the attention of the astronomical community in the 1960s and 1970s by the work of [Vera Rubin](#) at the [Carnegie Institute](#) in Washington, who mapped in detail the rotation velocities of stars in a large sample of spirals. While Newton's Laws predict that stellar rotation velocities should decrease with distance from the galactic center, Rubin and collaborators found instead that they remain almost constant<sup>[7]</sup> – the [rotation curves](#) are said to be "flat". This observation necessitates at least one of the following: 1) There exists in galaxies large quantities of unseen matter which boosts the stars' velocities beyond what would be expected on the basis of the visible mass alone, or 2) Newton's Laws do not apply to galaxies. The former leads to the dark matter hypothesis; the latter leads to MOND.



MOND was proposed by Mordehai Milgrom in 1983

The basic premise of MOND is that while Newton's laws have been extensively tested in high acceleration environments (in the Solar System and on Earth), they have not been verified for objects with extremely low acceleration, such as stars in the outer parts of galaxies. This led Milgrom to postulate a new effective gravitational force law (sometimes referred to as "Milgrom's law") that relates the true acceleration of an object to the acceleration that would be predicted for it on the basis of Newtonian mechanics.<sup>14</sup> This law, the keystone of MOND, is chosen to reduce to the Newtonian result at high acceleration but lead to different ("deep MOND") behaviour at low acceleration:

$$\mathbf{F}_N = m\mu\left(\frac{a}{a_0}\right)\mathbf{a} \dots\dots[\text{Eq.VI-1}]$$

Here  $\mathbf{F}_N$  is the Newtonian force,  $m$  is the object's (gravitational) [mass](#),  $\mathbf{a}$  is its acceleration,  $\mu(x)$  is an as-yet unspecified function (known as the "interpolating function"), and  $a_0$  is a new fundamental constant which marks the transition between the Newtonian and deep-MOND regimes. Agreement with Newtonian mechanics requires  $\mu(x) \rightarrow 1$  for  $x \gg 1$ , and consistency with astronomical observations requires  $\mu(x) \rightarrow x$  for  $x \ll 1$ . Beyond these limits, the interpolating function is not specified by the theory, although it is possible to weakly constrain it empirically.<sup>18|19</sup> Two common choices are:

$$\mu\left(\frac{a}{a_0}\right) = \left(1 + \frac{a_0}{a}\right)^{-1}$$

("Simple interpolating function")....[Eq.VI-2] and

$$\mu\left(\frac{a}{a_0}\right) = \left(1 + \left(\frac{a_0}{a}\right)^2\right)^{-1/2}$$

("Standard interpolating function").....[Eq.VI-3]

Replacing  $a_0$  with cycle time parameter  $n$  and unitizing  $a=1$  gives the scale factor of Quantum Relativity in the forms  $1/\{(a+a_0)/a\} \rightarrow \{n/(1+n)\}$  and  $1/\sqrt{\{a^2+a_0^2\}/a^2} \rightarrow \sqrt{\{n^2/1+n^2\}}$

Thus, in the deep-MOND regime ( $a \ll a_0$ ):

$$F_N = ma^2/a_0 \dots[\text{Eq.VI-4}]$$

Applying this to an object of mass  $m$  in [circular orbit](#) around a point mass  $M$  (a crude approximation for a star in the outer regions of a galaxy), we find:

$$\frac{GMm}{r^2} = m \frac{\left(\frac{v^2}{r}\right)^2}{a_0} \Rightarrow v^4 = GMa_0$$

[Eq.VI-5]

that is, the star's rotation velocity is independent of its distance  $r$  from the center of the galaxy – the rotation curve is flat, as required. By fitting his law to rotation curve data, Milgrom found  $a_0 \approx 1.2 \times 10^{-10} \text{ m s}^{-2}$  to be optimal. This simple law is sufficient to make predictions for a broad range of galactic phenomena.

Milgrom's law can be interpreted in two different ways. One possibility is to treat it as a modification to the classical [law of inertia](#) (Newton's second law), so that the force on an object is not proportional to the particle's acceleration  $a$  but rather to  $\mu(a/a_0)a$ . In this case, the modified dynamics would apply not only to gravitational phenomena, but also those generated by other [forces](#), for example [electromagnetism](#).<sup>[10]</sup> Alternatively, Milgrom's law can be viewed as leaving Newton's Second Law intact and instead modifying the inverse-square law of gravity, so that the true gravitational force on an object of mass  $m$  due to another of mass  $M$  is roughly of the form  $GMm/(\mu(a/a_0)r^2)$ . In this interpretation, Milgrom's modification would apply exclusively to gravitational phenomena.

[End of excerpt]

**For  $\Lambda$ CDM:**

acceleration  $a$ :  $a = G\{M_{\text{BM}}+m_{\text{DM}}\}/R^2$

**For MOND:**

acceleration  $a$ :  $a+a_{\text{mil}} = a\{a/a_0\} = GM_{\text{BM}}/R^2 = v^4/a_0.R^2$

for  $v^4 = GM_{\text{BM}}a_0$   $a_{\text{mil}} = a\{a/a_0-1\} = a\{a-a_0\}/a_0 = GM_{\text{BM}}/R^2 - a$

For Newtonian acceleration  $a$ :  $G\{M_{\text{BM}}+m_{\text{DM}}\}/R^2 = a = GM_{\text{BM}}/R^2 - a_{\text{mil}}$   
 $= - Gm_{\text{DM}}/R^2 = (a/a_0)(a-a_0)$  and relating the Dark Matter to the Milgröm constant in interpolation  $a_{\text{mil}}$

Applied for the Milgröm deceleration applied to the Dark Matter and incorporating the radial independence of rotation velocities in the galactic structures as an additional acceleration term in the Newtonian gravitation as a function for the total mass of the galaxy and without DM in MOND.

Both,  $\Lambda$ CDM and MOND consider the Gravitational 'Constant' constant for all accelerations and vary either the mass content in  $\Lambda$ CDM or the acceleration in MOND in the Newtonian Gravitation formulation respectively.

The standard gravitational parameter GM in a varying mass term  $G(M+m) = M(G+\Delta G)$  reduces to  $Gm=\Delta GM$  for a varying Gravitational parameter G in  $(G+\Delta G) = f(G)$ .

The Dark Matter term  $Gm_{DM}$  can be written as  $Gm_{DM}/R^2 = -a_{mil} = a - a^2/a_o = \Delta GM/R^2$  to identify the Milgröm acceleration constant as an intrinsic and universal deceleration related to the Dark Energy and the negative pressure term of the cosmological constant invoked to accommodate the apparent acceleration of the universal expansion ( $q_{ds} = -0.55858$ ).

$\Delta G = G_o - G(n)$  in  $a_{mil} = -2cH_o/[n+1]^3 = \{G_o - G(n)\}M/R^2$  for some function G(n) descriptive for the change in f(G).

The Milgröm constant so is not constant but emerges as the initial boundary condition in the Instanton aka the Quantum Big Bang and is identified as the parametric deceleration parameter in Friedmann's solutions to Einstein's Field Equations in  $a_{mil} \cdot a_o = a(a - a_o)$  and  $a_o(a_{mil} + a) = a^2$  or  $a_o = a^2/(a_{mil} + a)$ .

$a_{mil} = -2cH_o/[n+1]^3 = -\{G_o - G(n)\}M/R^2 = -G_o\{1 - X^n\}M/R^2$  for the gravitational parameter GM coupled to the size of a galactic structure harboring a central Black Hole-White Hole/Quasar power source.

$A(n) = -2cH_o/[n+1]^3 = -2cH_o^2/R_H[n+1]^3$  and calculates as  $-1.112663583 \times 10^{-9} \text{ (m/s}^2\text{)}^*$  at the Instanton and as  $a_{mil} = -1.1614163 \times 10^{-10} \text{ (m/s}^2\text{)}^*$  for the present time coordinate.

The Gravitational Constant  $G(n) = G_o X^n$  in the standard gravitational parameter represents a fine structure in conjunction with a sub scale quantum mass evolution for a proto nucleon mass  $m_c = \alpha^9 \cdot m_{planck}$  from the gravitational interaction fine structure constant  $\alpha_g = 2\pi G_o m_c^2 / hc = 3.438304 \dots \times 10^{-39} = \alpha^{18}$  to unify electromagnetic and gravitational quantum interactions.

The proto nucleon mass  $m_c(n)$  so varies as complementary fine structure to the finestructure for G in  $m_c Y^n$  for a truly constant  $G_o$  as defined in the interaction unification.

$G(n)M(n) = G_o X^n \cdot M_o Y^n = G_o M_o (XY)^n = G_o M_o$  in the macro evolution of baryonic mass seedling  $M_o$  and  $G_o m_c$  in the micro evolution of the nucleonic seed remain constant to describes a particular fine structure for the time frame in the cosmogenesis when the non-luminous Dark Matter remains separate from the luminous Baryon mass.

The DM-BM intersection coordinate is calculated for a cycle time  $n = H_o t = 1.4142 \dots$  or at a universal true electromagnetic age of 23.872 billion years.

At that time, the {BM-DM-DE} mass density distribution will be {5.536%; 22.005%; 72.459%}, with the  $G(n)M(n)$  assuming a constant value in the Hubble cycle.

The Dark Energy pressure will be  $P_{PBM\cap DM} = -3.9300 \times 10^{-11} \text{ (N/m}^2\text{)}^*$  with a corresponding 'quasi cosmological constant' of  $\Lambda_{BM\cap DM} = -6.0969 \times 10^{-37} \text{ (s}^{-2}\text{)}^*$ .

Within a local inertial frame of measurement, the gravitational constant so becomes a function of the micro evolution of the proto nucleon mass  $m_c$  from the string epoch preceding the Instanton.

A localized measurement of  $G$  so engages the value of the mass of a neutron as evolved  $m_c$  in a coupling to the evolution of the macro mass seedling  $M_o$  and so the baryonic omega

$\Omega_o = M_o/M_H = 0.02803115$  in the critical density  $\rho_{\text{critical}} = 3H_o^2/8\pi G_o = 3M_H/4\pi R_H^3 = 3c^2/8\pi G_o R_H^2$  for the zero curvature and a Minkowski flat cosmology.

The fine structure for  $G$  so engages both the micro mass  $m_c$  and the macro mass  $M_o$ , the latter being described in the overall Hypermass evolution of the universe as a Black Hole cosmology in a 5/11D AdS 'closed' spacetime encompassing the dS spacetime evolution of the 4/10D 'open' universe.

The Milgröm 'constant' so relates an intrinsic Dark Energy cosmology to the macro cosmic hypermass evolution of Black Holes at the cores of galaxies and becomes universally applicable in that context.

A New View on Gravity and the Cosmos | Erik Verlinde

Total Entropy  $L = \frac{c}{H_0}$

$$S(L) = k_B \frac{A(L)c^3}{4G\hbar}$$

Temperature

$$k_B T = \frac{\hbar H_0}{2\pi}$$

Entropy and Temperature are due to positive dark energy.

No modification of Newtonian gravitation is necessary, if the value of a locally derived and measured  $G$  is allowed to increase to its string based (Planck-Stoney) value of  $G_o = 1/k = 4\pi\epsilon_o = 1.111... \times 10^{-10}$  string unification units [ $C^* = m^3/s^2$ ] and relating spacial volume to angular acceleration in gravitational parameter  $GM$ .

The necessity for Dark Matter to harmonize the hypermass evolution remains however, with the Dark Energy itself assuming the form of the Milgröm deceleration.

That the Dark Energy is positive as a negative Einstein quintessence is also pointed out as a cosmological effect by Erik Verlinde in his 'Emergent Gravity' model in associating the Milgröm deceleration with the Hubble Constant and therefore the Friedmann standard cosmology. <https://arxiv.org/pdf/1611.02269.pdf>

The scale factor ( $a = n/[n+1]$ ) radius at the instanton-inflaton is  $R(n_{ps}) = R_H(n_{ps}/(n_{ps}+1)) = R_H \lambda_{ps}/R_H = \lambda_{ps}$  in the limit for  $n_{ps} = \lambda_{ps}/R_H = 6.259 \times 10^{-49} \sim 0$

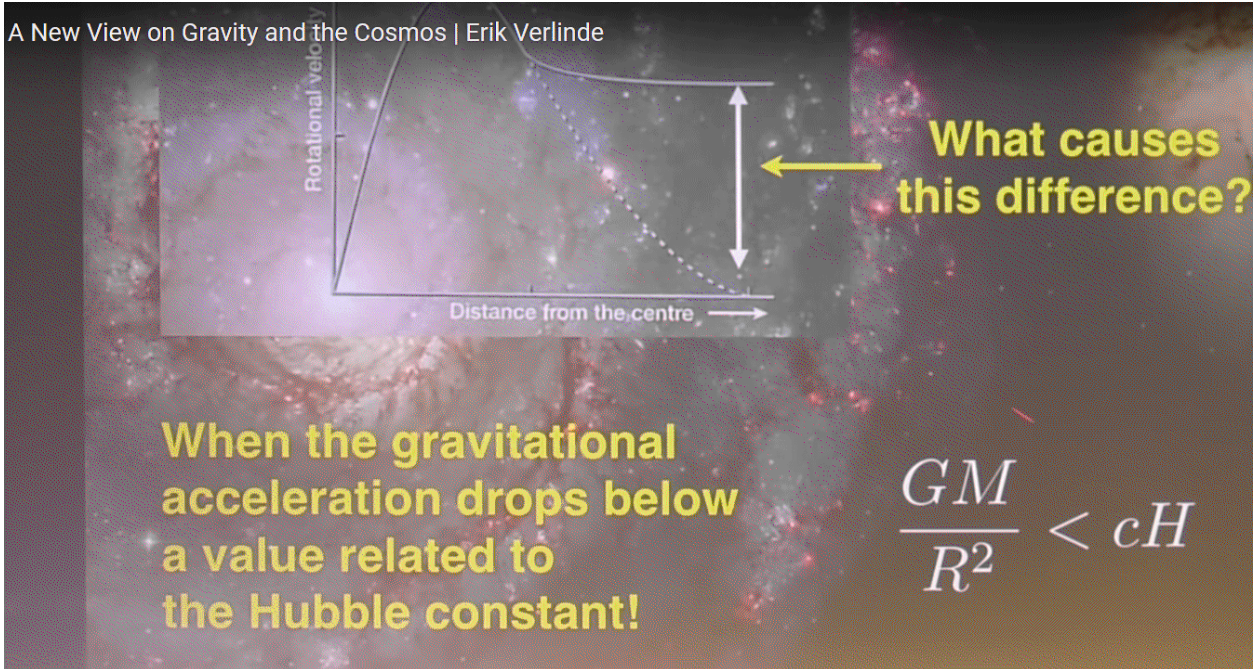

This coupling of the EMMR physical consciousness in the Restmass Photons or RMPs in the form of monopolar displacement currents therefore relates the expansion of the universe to cycle time  $n=H_0t$  to the radial size of the Dark Matter Haloes or DMHs at particular coordinates of cycle time  $n$ .

### Dark Matter Halos and Physicalized Consciousness

At the Instanton  $n=n_{ps}$  for  $M_0/\lambda_{ps}^2 = \Lambda_0/G_0 = \text{constant} = 1.8137 \times 10^{95} \text{ [kg/m}^2\text{]}$ \* and when all the DM was contained within the Weyl wormhole as a minimum radius for the DMHs.

At the Inflaton Hubble boundary as a prospective DMH maximum, an infinite  $n$  for  $M_H/R_H^2 = c^2/2R_H G_0 = \text{constant} = 2.5349 \dots \text{ [kg/m}^2\text{]}$ \* and when all the DM would be within the Inflaton defined Hubble event horizon.

This boundary will however remain 'out of bounds' for the asymptotic expansion of Universe.

Universe will quantum tunnel 234.47 cycles or about 4 Trillion years after the Instanton into the second universe as a Multiverse defined 16.9 Billion years after the Instanton and when the 11dimensional EMR light path had reached the Hubble event horizon as the AdS negatively curved boundary of the hyperbolic cosmology of the convex lensed Witten mirror separating Shadow Universe Khaibit from Universe.

**Universal Galactic Cell:.....  $G_0M/R^2 = 2cH_0\{n^2/(n+1)^5\}$  .....[Eq.VI-6]**

**for constant initial Milgröm deceleration  $2cH_0 = 2c^2/R_H = 1.12663683 \times 10^{-9} \text{ [m/s}^2\text{]}$ \***



The expansion of the universe given in the dark energy DE in the gravitational acceleration

$G_o M_o / R(n)^2 = G_o \sum M_{\text{galaxy}} / \sum R_{\text{galaxy}}^2 = G_o M_o / R_{\text{sarkar}}^2$  in describing the Black Hole defined by the curvature radius  $R_{\text{sarkar}} = 2G_o M_o / c^2 = 2G_o M_H / c^2 = \Omega_o R_H = 4.4783... \times 10^{24} \text{ m}^*$  and for the encompassment of the universe at cycle time coordinate  $n_{\text{sarkar}} = R_{\text{sarkar}} / \{R_H - R_{\text{sarkar}}\} = 0.0283... = \Omega_o = M_o / M_H$  from  $R(n) = R_{\text{sarkar}} = R_H \{n / (n+1)\}$  and  $R_H / R_{\text{sarkar}} = 1 + 1 / n_{\text{sarkar}}$ .

This so considers mass seed  $M_o$  to be distributed as the baryon luminous matter seed in a summation of galaxies mass  $M$  and radius  $R$  and within a daughter Black Hole defining the extent of universe at the Sarkar curvature radius containing  $M_o$ .

The nonluminous dark matter DM then extends the baryon seed as the fraction added to the  $\Omega_{\text{BM}}(n) = \Omega_o Y^n = M_o Y^n / M^H$  to allow  $\Omega(n) = \Omega_{\text{BM}}(n) + \Omega_{\text{DM}}(n) = 1$

The DE does not participate in this matter distribution until it activates at the  $n=1/2$  coordinate 8.445 Billion years after the Instanton.

For any cycle time  $n > 1/2$ , the matter energy distribution  $\Omega(n) = \Omega_{\text{BM}}(n) + \Omega_{\text{DM}}(n) + \Omega_{\text{DE}}(n) = 1 = \{M_o / M_H\} \text{ mod } 1$ .

$$\{M/R^2\} \{R_{\text{sarkar}}^2 / M_o\} \{M_H / R_H^2\} = \{M/R^2\} \cdot \{M_o / M_H\} \text{ mod } 1 = \{n / (n+1)\}^2 \cdot \{2cH_o / G_o (n+1)^3\} =$$

$\{2c^2 / G_o R_H\} \{n^2 / (n+1)^5\} \dots$  as the total mass energy seed

$\{M/R^2\} \cdot \Omega_{\text{BM}}(n) = \{2c^2 / G_o R_H\} \{n^2 / (n+1)^5\} \dots$  as the baryonic luminous mass energy seed for the stellar disk of a galaxy mass  $M$  and Radius  $R$

$\{M/R^2\} \cdot \Omega_{\text{DM}}(n) = \{2c^2 / G_o R_H\} \{n^2 / (n+1)^5\} \dots$  as the DM Outer Halo or DMOH mass energy

seed and  $\Omega_{\text{DM}}(n) = 1 - \Omega_{\text{BM}}(n)$  for  $n < 1/2$  and  $\Omega_{\text{DM}} = \Omega_{\text{BM}} [1 + 1/n]^3 - 1$

$\{M/R^2\} \cdot \Omega_{\text{DE}}(n) = \{2c^2 / G_o R_H\} \{n^2 / (n+1)^5\} \dots$  as the DE Boundary Halo or DEBH mass energy seed for  $n > 1/2$

The Milky Way is an observer relative right-handed barred spiral galaxy with its complementary left-handed barred spiral Andromeda and the Pinwheel galaxy all of a total BM+DM mass of  $2 \times 10^{42} \text{ kg}$  for each galaxy.

They differ in their visible stellar extent, Andromeda the largest at 220,000 light years across, followed by the Pinwheel galaxy at 170,000 light years across and the Milky Way 120,000 light years across.

This indicates that the three galaxies are of comparable equal mass but differ in their DM content inversely proportional to their RMP galactic space-occupancy awareness evolution of physical consciousness as monopolar energy distribution.



Milky Way Galaxy (Left)-----Andromeda Galaxy (Middle and Right)



The DM halos are calculated from the known distribution of  $\Omega(n) = \Omega_{BM}(n) + \Omega_{DM}(n) + \Omega_{DE}(n) = 1$

For a present  $n=1.132712$  :

$$\Omega_0 Y^n + \Omega_0 Y^n \{(1+1/n)^3 - 1\} + \{1 - \Omega_{BM}(n) - \Omega_{DM}(n)\} = 0.0483 + 0.2741 + 0.6776 = 1$$

$$\text{For a } n=2/3 : \Omega_0 Y^n + \Omega_0 Y^n \{(1+1/n)^3 - 1\} + \{1 - \Omega_{BM}(n) - \Omega_{DM}(n)\} = 0.0386 + 0.5645 + 0.3969 = 1$$

For the onset of DE at  $n=1/2$  and the cosmological redshift  $z=0.6124\dots$  :

$$\Omega_0 Y^n + \Omega_0 Y^n \{(1+1/n)^3 - 1\} + \{1 - \Omega_{BM}(n) - \Omega_{DM}(n)\} = \Omega_0 Y^{1/2} + \{1 - 0.03565\} = 0.03565 + 0.9270 + 0.0373 = 1$$

For the 'galaxy formation peak' defined in the Einstein quintessence minimum and for a cosmological redshift of  $z=1.177\dots$ ; so, 4 Billion years after the Instanton  $n_{gp}=0.2389$  :

$$\Omega_0 Y^n + \{1 - \Omega_{BM}(n)\} + 0 = 0.03144 + 0.9686 + 0 = 1$$

For the beginning of galaxies at the Einstein-quintessence zero for cosmological redshift  $z=2.125$ ; 1.83 Billion years after the Instanton;  $n_g=0.10823\dots$   $1 = \Omega_o \gamma^n + \{1 - \Omega_{BM}(n)\} + 0 = 0.02953 + 0.97047 + 0 = 1$

For the stellar disks of the three galaxies under consideration and for  $f\{M/R^2\} = \{2c^2/G_o R_H\}\{n^2/(n+1)^5\} = 0.2949$  for  $n_p=1.13271$ .

Function  $f\{M/R^2\}$  increases from 0 at  $n_{ps}$  to 0.0710 for  $n_g=0.10823$  to 0.1983 for  $n_{gp}=0.2389$  to 0.3338 for  $n=1/2$  to a relative maximum at  $n=2/3$  for  $\{2c^2/G_o R_H\}\{108/3125\} = 0.35043$  to subsequently decrease from this maximum at 11.25 Billion years after the Instanton or 7.87 Billion years from the present epoch.

$n=1/2$  defines the onset of the Dark Energy and results in the measurement of an apparently accelerating universe, 8.438 Billion years after the Instanton or  $19.12 - 8.44 = 10.68$  Billion years from the present in Anti-deSitter spacetime and  $14.64 - 8.44 = 6.20$  Billion years ago in deSitter spacetime.

The time period from  $n=1/2$  to a relative maximum at  $n=2/3$  and  $10.68 - 7.87 = 2.81$  Gy, so characterizes the introduction of a physicalized DE into the cosmology.

In that epoch, the components of the distribution  $\Omega(n) = \Omega_{BM}(n) + \Omega_{DM}(n) + \Omega_{DE}(n) = 1$  changed in decreasing the Dark Matter DM fraction in lieu of the Dark Energy DE fraction.

This had the effect of 'physicalizing' galactic consciousness in a redistribution of the 'missing mass' given in the  $q_o = 1/2 \Omega_o = \Lambda_o/A_{dB} = M_o/2M_H = 0.014015\dots$  Deceleration-Omega parameter.

As the  $n=1/2$  cycle coordinate defines the midpoint between the two extremum nodes in the 'Oscillation of the Hubble Constant' and metaphysically termed as the 'Heartbeat of the Great Mother Baab'; the 'Father White Hole' in AdS spacetime becomes synchronized with the 'Mother Black Hole' in dS spacetime in their respective Hubble horizons in AdS and dS.

In AdS  $nR_{HAdS} = \{1-1/n+1\}R_{HdS}$  in dS for  $n=1$  coinciding with the birth of the second universe in parallel time space and collocal as a multiverse with the protoverse as the seedling universe.

In quantum theoretical terms, the  $n=1/2$  cycle time coordinate introduced the Restmass Photon RMP as a mass energy equivalent for physicalized universal consciousness in changing its nature from a Dark Matter particle to a Dark Energy particle. As more VPE transmutes from DM into DE and BM in the universal mass evolution; the transformed 'dark and non-luminous mass energy' begins to 'shine' in a cosmic phenomenon, which can be called the synergy between wave-mind and particle-body or the psychosoma of Aurobindo's Supramentalisation of 'divinized' matter.

Dark Energy so crystallizes itself as physicalized universal consciousness in itself and as a transformation from prior to evolved states of energy defined in the creation events and agenda of Abba and his Logos.

$\{M/R^2\}\{0.0483\} = 0.2949$  for a BMIH Inner Halo stellar radius of  $R_{milkyway} = 5.723 \times 10^{20} m^*$  or  $R_{mw}/\{c.365.2425.86,400\} = 60,455$  light years ly and  $\Omega_{BM}/\Omega_{DM} = 0.0483/0.3224 = 0.150$  for  $n_p$  and  $\Omega_{BM}/\Omega_{DM} = 0.03863/0.35043 = 0.11024$  for  $n=2/3$  and  $\Omega_{BM}/\Omega_{DM} = 0.03565/0.9270 = 0.0385$  for  $n=1/2$  and  $\Omega_{BM}/\Omega_{DM} = 0.03144/0.9686 = 0.0325$  for  $n_{gp}$  showing the evolution of the galaxy in time with a small increase in Higgs-RMP mass reducing the DM inertia in increased space awareness, generalised in  $df_{ps}/dt = d\{1/f_{ss}\}/dt$ .

$\{M/R^2\}\{0.2741+0.0483\} = 0.2949$  for a DMOH Outer Halo of  $R_{mw} = 1.479 \times 10^{21} m^*$  or  $R_{mw}/\{c.365.2425.86,400\} = 156,192$  ly

$\{M/R^2\}\{0.6776+0.3224\} = 0.2949$  for a DEBH Boundary Halo of  $R_{mw} = 2.604 \times 10^{21} \text{ m}^*$  or  $R_{mw}/\{c.365.2425.86,400\} = 275,081 \text{ ly}$

As the inversion of the wormhole radius of the Instanton defines the coupling of supermembrane Eps.Ess; the galactic separation parameter is given in  $r_{ss}|_{\min} = 10^{22} \text{ m}^*$  or 1.056 Million ly and  $r_{ss}|_{\max} = 2\pi \times 10^{22} \text{ m}^*$  in  $6.637 \times 10^6 \text{ ly}$ .

For  $n=2/3$  :

$\{M/R^2\}\{0.03863\} = 0.35043$  for a BMIH Inner Halo of  $R_{mw} = 4.695 \times 10^{20} \text{ m}^*$  or 49,598 ly

$\{M/R^2\}\{0.6031\} = 0.35043$  for a DMOH Outer Halo of  $R_{mw} = 1.855 \times 10^{21} \text{ m}^*$  or 195,942 ly

$\{M/R^2\}\{1\} = 0.35043$  for a DEBH Boundary Halo of  $R_{mw} = 2.389 \times 10^{21} \text{ m}^*$  or 252,347 ly

For  $n=1/2$  and a universal extent of 8.438 Billion light years as  $R_{DE} = 7.988 \times 10^{25} \text{ m}^*$  as galaxy crystallization from the group galaxy seed from the supercluster seed, centred on the Milky Way seed and manifesting the Milky Way seed as a major galaxy in the onset of DE participation in the mass energy evolution.

$\{M/R^2\}\{0.03565\} = 0.9270$  for a BMIH Inner Halo of  $R_{mw} = 2.773 \times 10^{20} \text{ m}^*$  or 29,295 ly

$\{M/R^2\}\{0.96265\} = 0.9270$  for a DMOH Outer Halo of  $R_{mw} = 1.441 \times 10^{21} \text{ m}^*$  or 152,227 ly

$\{M/R^2\}\{1\} = 0.9270$  for a DEBH Boundary Halo of  $R_{mw} = 1.469 \times 10^{21} \text{ m}^*$  or 155,153 ly

For  $n=n_{gp}=0.2389$  and a universal extent of 4.032 Billion light years as  $R_{gp} = 3.817 \times 10^{25} \text{ m}^*$  as galaxy crystallization from a group galaxy seed from a supercluster seed, centred on the Milky Way seed.

$\{M/R^2\}\{0.03144\} = 0.1983$  for a BMIH Inner Halo of  $R_{mw} = 5.631 \times 10^{20} \text{ m}^*$  or 59,481 ly

$\{M/R^2\}\{1\} = 0.1983$  for a DMOH Outer Halo of  $R_{mw} = 3.176 \times 10^{21} \text{ m}^*$  or 335,457 ly

For  $n=n_g=0.10823$  and a universal extent of 1.826 Billion light years as  $R_g = 1.729 \times 10^{25} \text{ m}^*$  as the group galaxy crystallization seed from the supercluster seed, centred on the Milky Way seed  $\{M/R^2\}\{0.02953\} = 0.0710$  for a BMIH Inner Halo of  $R_{mw} = 9.120 \times 10^{20} \text{ m}^*$  or 96,339 ly

$\{M/R^2\}\{1\} = 0.0710$  for a DMOH Outer Halo of  $R_{mw} = 5.307 \times 10^{21} \text{ m}^*$  or 560,621 ly from the Local Group

For  $n=n_{\text{supercluster}}=\Omega_o=0.02803$  and a universal extent of 473.037 Million light years as  $R_{\text{sarkar}} = 4.4783 \times 10^{24} \text{ m}^*$  as the supercluster seed, centred on the Milky Way seed

$\{M/R^2\}\{0.02841\} = 0.0069$  for a BMIH Inner Halo of  $R_{mw} = 2.870 \times 10^{21} \text{ m}^*$  or 303,117 ly

$\{M/R^2\}\{1\} = 0.0069$  for a DMOH Outer Halo of  $R_{mw} = 1.703 \times 10^{22} \text{ m}^*$  or 1,798,350 ly from the Laniakea Supercluster

For  $n=1/2\Omega_o=q_o=0.0140$  and a universal extent of 236.519 Million light years as  $1/2R_{\text{sarkar}} = 2.239 \times 10^{24} \text{ m}^*$  as the supercluster seed initiation, centred on the Milky Way seed

$\{M/R^2\}\{0.02822\} = 0.0019$  for a BMIH Inner Halo of  $R_{mw} = 5.450 \times 10^{21} \text{ m}^*$  or 575,706 ly

$\{M/R^2\}\{1\} = 0.0019$  for a DMOH Outer Halo of  $R_{mw} = 3.244 \times 10^{22} \text{ m}^*$  or 3,427,061 ly from the Laniakea Supercluster

For  $n_{\min} = \frac{1}{2}q_0 = \frac{1}{4}\Omega_0 = 0.0070075$  as a potential 118.3-Million-year marker for a galaxy of mass  $M = 2 \times 10^{42} \text{ kg}^*$ , such as the Milky Way and Andromeda and Pinwheel and as a consequence of the Inflation parameters of supermembrane  $E_{ps}$  in  $r_{ss}|_{\max} = 1/r_{ps} = 2\pi/\lambda_{ps} = 2\pi\lambda_{ss}$  as the Milky Way seed

$\{M/R^2\}_{\{0.028125\}} = 0.00048$  for a BMIH Inner Halo of  $R_{mw} = 1.0816 \times 10^{22} \text{ m}^*$  or 1,142,479 ly

$\{M/R^2\}_{\{1\}} = 0.00048$  for a DMOH Outer Halo of  $R_{mw} = 6.4550 \times 10^{22} \text{ m}^*$  or 6,818,331 ly

The Birth of the Milky Way galaxy as one of the firstborn galaxies in Universe and the home galaxy of Baab's Earth is so calculated at 118.3 Million years after the birth of time and space at the Instanton

$n_{ps} = \lambda_{ps}/R_H = H_0/f_{ps}$ . and for synchronization and connectivity between Khaibit and Universe as the diameter  $\emptyset = 2R_H$ .

As the DM distribution in a galaxy reflects its physical consciousness evolution in terms of the monopolar displacement currents and the RMP derived from the Higgs Boson; galaxies with well-defined central supermassive Black Holes and older elliptical galaxies are more evolved in their DM content.

As Black Holes drive the evolution of all galaxies, well defined Black Holes indicate more dark matter in their host galaxies total mass energy content, than younger and evolving galaxies, characterised by ubiquitous star formation and smaller central Black Holes, or Ultra-Luminous-X-ray sources or ULX sources. ULX sources are related to quasars and the ylemic protostars as 'inversed' Black Holes or White Holes, characterised by high temperatures and luminosities.

The RMP's quantum geometric template is  $YYCCMM(-1) = Y^2C^2M^2(-1) = YCM(-\frac{1}{2}) + YCM(\frac{1}{2})$  and so allows the DM gauge ambassador 'particle' to merge with two left-handed WNI neutrons as mass-energy increase by the Higgs Field  $YYCCMM(0) = YCM(0) + YCM(0)$ .

The growth of the baryon mass seed  $M_0$  in  $\Omega(n) = \Omega_0 Y^n$  so represents the 'growing in physical consciousness' of matter itself. Logos called this the 'Aurobindo Supramentalisation of Matter' in the monopolar displacement currents of Universe as a mass increase.

The Milky Way hosts the local star system Raahsol and Earth and so Abba's Baab focus on the center of Earth and so is the template for the general evolution of galaxies as cells in the metaphysical body of Adam and Eve.

The DM distribution of the Milky Way so calibrates the DM distribution relative to the Inner Halo, the Outer Halo, and the DE boundary.

$R_{mwBMIH}/R_{andBMIH} = 60,455/110,000 = 0.55$  for  $0.0483/0.55^2 = 0.160$  Andromeda's relative baryonic mass fraction

$R_{mwBMIH}/R_{pinBMIH} = 60,455/85,000 = 0.71$  for  $0.0483/0.71^2 = 0.0958$  as Pinwheel's baryonic mass fraction

$\{M/(1.08 \times 10^{42})\}_{\{0.160\}} = 0.2949$  for a BMIH stellar radius of  $R_{andromeda} = 1.04 \times 10^{21} \text{ m}^*$  or = 110,033 ly and  $\Omega_{BM}/\Omega_{DM} = 0.160/0.3224 = 0.496$

$\{M/R^2\}\{0.3224\} = 0.2949$  for a DMOH Halo of  $R_{\text{andromeda}} = 1.479 \times 10^{21} \text{ m}^*$  or  $R_{\text{and}} = 156,192 \text{ ly}$   $\{M/R^2\}\{1.0\} = 0.2949$  for a DEBH Halo of  $R_{\text{andromeda}} = 2.604 \times 10^{21} \text{ m}^*$  or  $R_{\text{and}} = 275,081 \text{ ly}$   $r_{\text{ss}}|_{\text{min}} = 10^{22} \text{ m}^*$  or 1.056 Million ly for a Galactic Halo of mass  $M_{\text{andromeda}}$

$\{M/(6.496 \times 10^{41})\}\{0.0958\} = 0.2949$  for a BMOH stellar radius of  $R_{\text{pinwheel}} = 8.060 \times 10^{20} \text{ m}^*$  or  $85,142 \text{ ly}$  and  $\Omega_{\text{BM}}/\Omega_{\text{DM}} = 0.0958/0.3224 = 0.297$

$\{M/R^2\}\{0.3224\} = 0.2949$  for a DMOH Halo of  $R_{\text{pinwheel}} = 1.479 \times 10^{21} \text{ m}^*$  or  $R_{\text{pin}} = 156,192 \text{ ly}$   $\{M/R^2\}\{1.0\} = 0.2949$  for a DEBH Halo of  $R_{\text{pinwheel}} = 2.604 \times 10^{21} \text{ m}^*$  or  $R_{\text{pin}} = 275,081 \text{ ly}$   $r_{\text{ss}}|_{\text{min}} = 10^{22} \text{ m}^*$  or 1.056 Million ly for a Galactic Halo of mass  $M_{\text{pinwheel}}$

For the Andromeda barred spiral galaxy or any galaxy seeded with a total BM+DM mass of  $2 \times 10^{42} \text{ kg}$ , the galaxy's DMOH radius would be  $1.479 \times 10^{21} \text{ m}^*$  or 156,192 light years for the present era and increase to  $3.176 \times 10^{21} \text{ m}^*$  or 335,457 light years at the peak of the galaxies as a function of the Einstein Quintessence for  $n_{\text{gp}}=0.2389$  and 4.032 Billion years from the Instanton, observing the galaxy backwards in cosmological time.

This galactic seed would increase further in its Dark Matter Outer Halo radius to  $5.307 \times 10^{21} \text{ m}^*$  or 560,621 light years at the onset of Galaxy formation at the DE zero at  $n_{\text{g}}=0.10823$  or 1.83 Billion years after the Instanton.

The consciousness evolution of galactic cell Andromeda and represented by its DMOH structure, would be evidenced in Andromeda's DMOH shrinking towards the universal Dark Energy nexus in more of the dark matter becoming 'illuminated' by the universal consciousness evolution of Universe and its parts as subsystems of galactic cells.

The Outer Halo for the Dark Matter Halo DMOH energy distribution is limited by the inversion of the wormhole radius  $r_{\text{ps}}$  in  $r_{\text{ss}} = 1/r_{\text{ps}} = 2\pi/\lambda_{\text{ps}} = 2\pi\lambda_{\text{ss}} = r_{\text{ss}}$  as a typical separation scale between large cellular galaxies such as Milky Way and Andromeda in  $6.28 \times 10^{22} \text{ m}^*$  as

$\text{DMOH}|_{\text{max}} = \{2\pi r_{\text{ss}}/c\}/\{365.2425 \times 24 \times 3600\} = 6.637 \times 10^6 \text{ light years}$  or  $6.637 \times 10^6 \text{ ly}/3.26 = 2035.9 \text{ kiloparsec kpc}$ .

Macro-cellular Modulation  $r_{\text{ss}}/2\pi = \lambda_{\text{ss}} = 10^{22} \text{ m}^*$  then characterizes the Dark Matter Consciousness Haloes around such major galaxies in  $10^{22} \text{ m}^*$  or as

$\text{DMH}|_{\text{min}} = \{r_{\text{ss}}/2\pi c\}/\{365.2425 \times 24 \times 3600\} = 1.056 \times 10^6 \text{ light years}$  or  $1.056 \times 10^6 \text{ ly}/3.26 = 324.02 \text{ kpc}$ .

# Milky Way halo structure

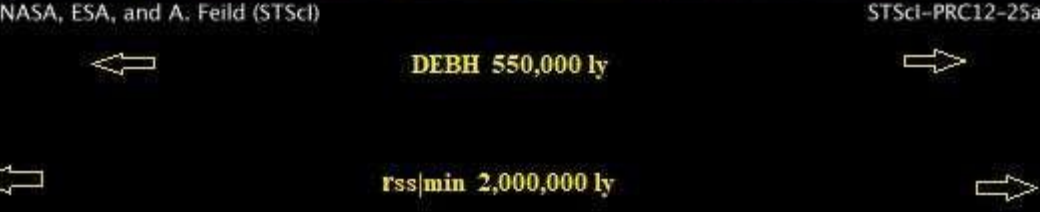
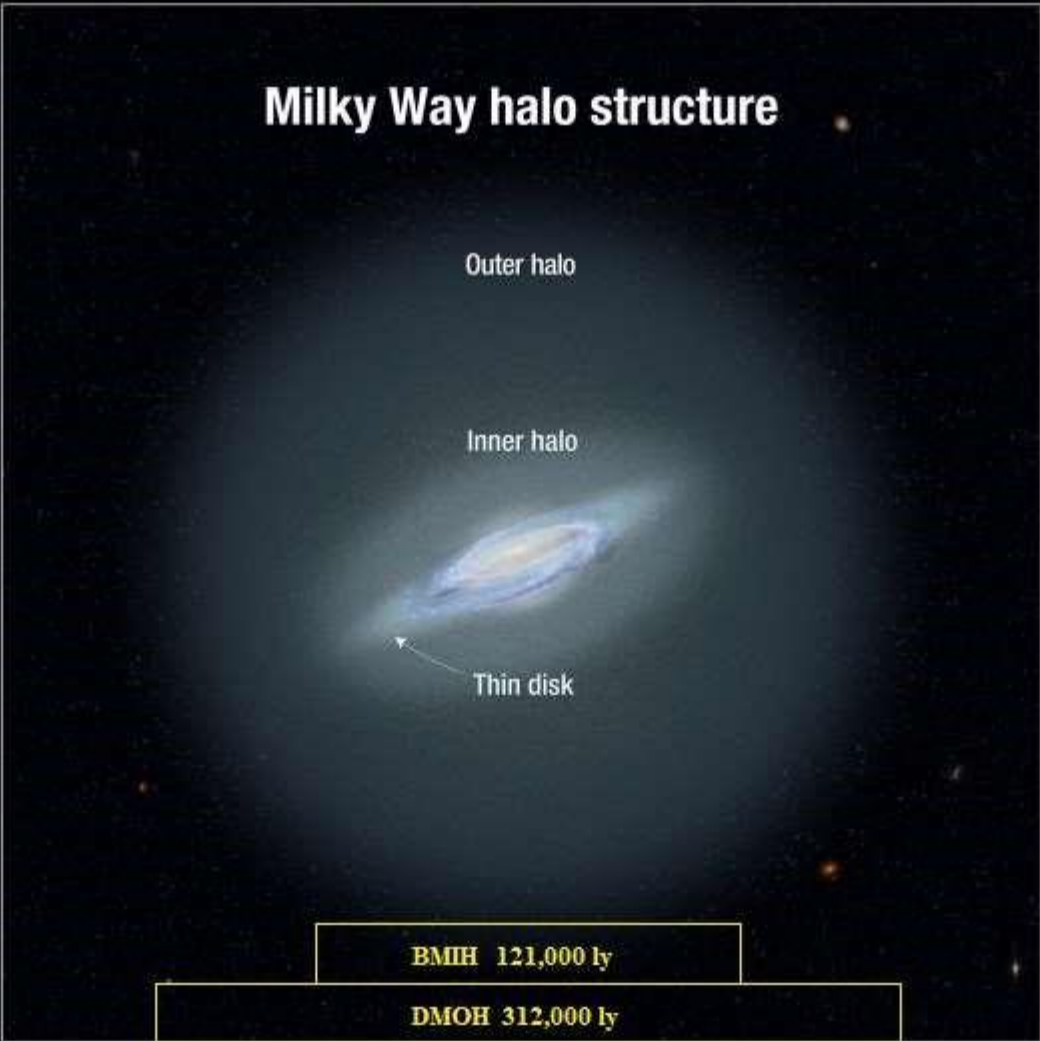

NASA, ESA, and A. Feild (STScI)

STScI-PRC12-25a

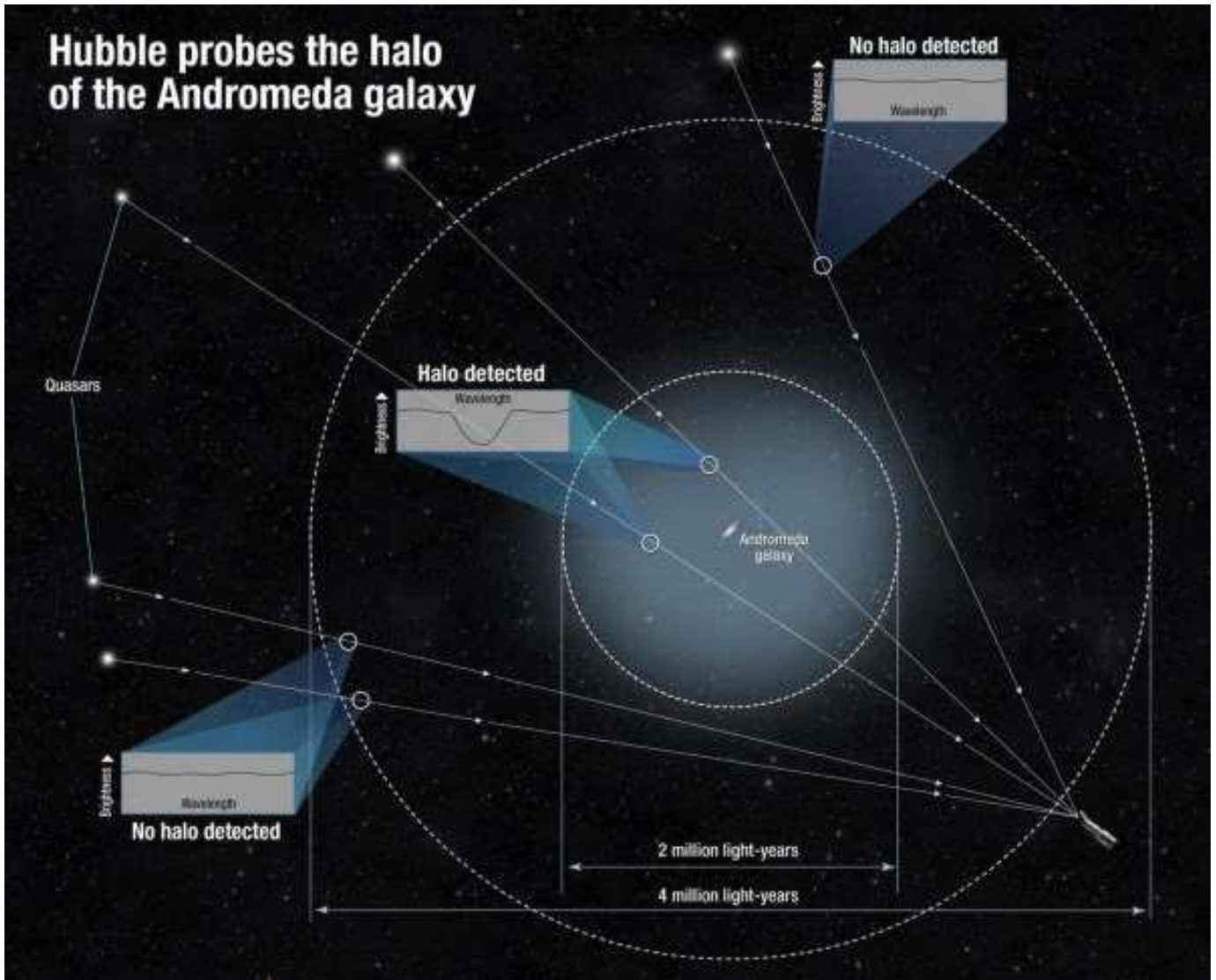

{s} <sub>SI</sub>	=	1.000978394	{s*}	=	0.999022562	{s} <sub>SI</sub>
{m} <sub>SI</sub>	=	1.001671357	{m*}	=	0.998331431	{m} <sub>SI</sub>
{kg} <sub>SI</sub>	=	1.003753126	{kg*}	=	0.996260907	{kg} <sub>SI</sub>
{C} <sub>SI</sub>	=	1.002711702	{C*}	=	0.997295631	{C} <sub>SI</sub>
{J} <sub>SI</sub>	=	1.005143377	{J*}	=	0.994882942	{J} <sub>SI</sub>
{eV} <sub>SI</sub>	=	1.00246560	{eV*}	=	0.997540464	{eV} <sub>SI</sub>
{K} <sub>SI</sub>		0.98301975	{K*}	=	1.017273559	{K} <sub>SI</sub>



## VIII: A Revision of the Friedmann Cosmology, Emergent Gravity, and Dark Energy as entangled Quantum Information in a Hypermass Multiverse

It is well known that the Radius of Curvature in the Field Equations of General Relativity relates to the Energy-Mass Tensor in the form of the critical density  $\rho_{\text{critical}} = 3H_0^2/8\pi G$  and the Hubble Constant  $H_0$  as the square of frequency or alternatively as the time differential of frequency  $df/dt$  as a cosmically applicable angular acceleration independent on the radial displacement.

The scientific nomenclature (language) then describes this curved space in differential equations relating the positions of the 'points' in both space and time in a 4-dimensional description called Riemann Tensor Space or similar.

This then leads mathematically to the formulation of General Relativity in Einstein's field Equations:

$$R_{\mu\nu} - \frac{1}{2}g_{\mu\nu} R + g_{\mu\nu} \Lambda = \frac{8\pi G}{c^4} T_{\mu\nu}$$

for the Einstein-Riemann tensor

$$G_{\mu\nu} = R_{\mu\nu} - \frac{1}{2}Rg_{\mu\nu},$$

and is built upon ten so-called nonlinear coupled hyperbolic-elliptic partial differential equations, which are mathematically rather complex and often cannot be solved analytically without simplifying the geometries of the parametric constituents (say objects interacting in so called tensor-fields of stress-energy  $\{T_{\mu\nu}\}$  and curvatures in the Riemann-Einstein tensor  $\{G_{\mu\nu}\}$ , either changing the volume in reduction of the Ricci tensor  $\{R_{ij}\}$  with scalar curvature  $R$  as  $\{Rg_{\mu\nu}\}$  for the metric tensor  $\{g_{\mu\nu}\}$  or keeping the volume of considered space invariant to volume change in a Tidal Weyl tensor  $\{R_{\mu\nu}\}$ ).

The Einstein-Riemann tensor then relates Curvature Radius  $R$  to the Energy-Mass tensor  $E=Mc^2$  via the critical density as  $8\pi G/c^4=3H_0^2V_{\text{critical}}M_{\text{critical}}\cdot c^2/M_{\text{critical}}\cdot c^4 = 3H_0^2V_{\text{critical}}/c^2 = 3V_{\text{critical}}/R^2$  as Curvature Radius  $R$  by the Hubble Law applicable say to a nodal Hubble Constant  $H_0 = c/R_{\text{Hubble}}$

The cosmological field equations then can be expressed as the square of the nodal Hubble Constant and inclusive of a 'dark energy' term often identified with the Cosmological Constant of Albert Einstein, here denoted  $\Lambda_{\text{Einstein}}$ .

Substituting the Einstein Lambda with the time differential for the square of nodal Hubble frequency as the angular acceleration acting on a quantized volume of space; however, naturally, and universally replaces the enigma of the 'dark energy' with a space inherent angular acceleration component, which can be identified as the 'universal consciousness quantum' directly from the standard cosmology itself.

The field equations so can be generalised in a parametrization of the Hubble Constant assuming a cyclic form, oscillating between a minimum and maximum value given by  $H_0=dn/dt$  for cycle time  $n=H_0t$  and where then time  $t$  is the 4-vector time-space of Minkowski light-path  $x=ct$ .

The Einstein Lambda then becomes then the energy-acceleration difference between the baryonic mass content of the universe and an inherent mass energy related to the initial condition of the oscillation parameters for the nodal Hubble Constant.

$$\Lambda_{\text{Einstein}} = G_o M_o / R(n)^2 - 2cH_o / (n+1)^3 = \text{Cosmological Acceleration} - \text{Native Universal Milgröm Deceleration}$$

As  $g_{\mu\nu}\Lambda = 8\pi G/c^4 T_{\mu\nu} - G_{\mu\nu}$  for  $G_{\mu\nu} = 8\pi G/c^4 T_{\mu\nu} - g_{\mu\nu}\Lambda$ , a negative integrated  $\Lambda = 0$  can appear as the energy-stress tensor  $8\pi G/c^4 T_{\mu\nu}$  always being greater than the curvature tensor  $G_{\mu\nu}$  and restated in a mass independent form for an encompassment of the curvature fine structures.

The Friedmann equations for the Friedmann-Robertson-Walker FRW model for the field equations of General Relativity relate the dark energy pressure  $P$  to the matter density  $\rho(t)$  as an integrated part of a Lambda Cold Dark Matter  $\Lambda$ CDM model for the multidimensional cosmology for a flat Minkowski universe, albeit as an effect of the collocal interaction of a positively curved de Sitter dS universe with a negatively curved Anti de Sitter AdS universe.

The  $g_{\mu\nu}\Lambda = 8\pi G/c^4 T_{\mu\nu} - G_{\mu\nu}$  cosmological constant-quintessence tensor becomes integrated as the difference between the Energy-Stress tensor  $8\pi G/c^4 T_{\mu\nu}$  and the curvature Einstein-Riemann tensor  $G_{\mu\nu}$  with negative pressure  $P(n,t)$  describing the matter density  $\rho(n,t)$  as a change in the time rate change of the Hubble parameter  $dH(n,t)/dt$  and therefore the change in the intrinsic Milgröm deceleration as a function of the nodal Hubble parameter.

Pressure  $P(n,t)$  as an energy per unit volume  $Mc^2/R^3$  and derivative  $P'(n,t)$  are always negative and increase as a function of the dark energy defined as an Einstein quintessence  $\Lambda(n)$  towards its  $w=0$  value for a matter dominated universe and can be considered integrated as  $P < \rho c^2$  as  $P = w\rho c^2 \quad \forall w < 0$

$$dP(n,t)/dt = P'(n,t) = \{2c^2 H_o^3 / 4\pi G_o\} \{ [T(n) - (2n+1)^2] / T(n)^3 \} - \{ 3(n+1)^2 / n^4 \} \{ M_o c^2 H_o / R_H^3 \} < 0 \quad \forall n, n_{ps} > 0$$

$$P'(n,t) = \{-2c^2 H_o^3 / 4\pi G_o\} \{ [3n^2 + 3n + 1] / T(n)^3 \} - \{ 3(n+1)^2 / n^4 \} \{ M_o c^2 H_o / R_H^3 \}$$

$$\{ 6\pi G_o M_o / c^2 R_H \} = 3\pi \Omega_o = 0.264176 > \{ nT[n] - n[2n+1]^2 \} / [n+1]^5 = -[3n^3 + 3n^2 + n] / [n+1]^5 < 0 \quad \forall n, n_{ps} > 0$$

The derivative of the integrated pressure is defined in a maximum where the matter density  $M_o c^2 / R(n)^3$  is equal to a polynomial function native to the integrated pressure in  $\Lambda'_p(n) = n(2n+1) / [n+1]^5$ .

## Einstein Quintessence Integrated Dark Energy Pressure

**Deceleration parameter**  $q(n) = -\{(d^2a/dt^2)(a)/(da/dt)^2\}$  for scale factor  $a = R(n,t)/R_H$

**Hubble Parameter**

$$H(n,t) = (da/dt)/a \text{ with } H(n=H_o t) = \{c/[n+1]^2\} / \{nR_H/[n+1]\} = H_o / (n[n+1]) = H_o / T(n)$$

$$dH(n,t)/dt = \{(d^2a/dt^2)/a - (da/dt)^2/a^2\} = -q(n) \{(da/dt)/a\}^2 - H(n,t)^2 = -H(n,t)^2 \{1+q(n,t)\}$$

$$dH/dt = -H_o^2 / (n^2[n+1]^2) \{1 + (2cH_o/[n+1]^3)(nR_H/[n+1])([n+1]^4/c^2)\} = -H_o^2 / (n^2[n+1]^2) \{1 + (2cnH_o R_H/c^2)\}$$

$$dH(n=H_o t)/dn = -\{H_o/T(n)\}^2 \{1+2n\} \text{ for } q(t) = -(dH/dt)/H(t)^2 - 1 = 1+2n-1 = 2n \text{ for dS expanding within AdS}$$

The AdS expansion has scale factor  $a = nR_H/R_H = n$  with invariant recession velocity  $c$  and 0 acceleration and is a function of  $n=H_0t$  limited in the Particle Hubble event horizon  $R_p(n) = T(n)R_H = n(n+1)R_H$ .

As the deceleration parameter will be  $q=2$  for  $n=1$  for the nodal Hubble boundary  $H_0$  for the dS-AdS spacetime mirror for the EMMI Lightpath a product  $q_{AdS} \cdot q_{dS} = 2n(1/2n - 1) = 1 - 2n$  with a superposed deceleration parameter  $q_{dS}$  for the cyclic cosmology of the EMR Lightpath initializes the dark energy onset for  $n=1/2$  to give the deceleration parameter product a zero value in  $q_{AdS} \cdot q_{dS} = 1 - 2(1/2) = 0$ .

This then defines  $q_{dS}(n) = 1/2n - 1$  generally and  $q_{dS} = -1/2$  for  $q_{AdS} = 2$  for the nodal Hubble bound  $n=1$

For a present cycle time coordinate  $n=1.1327127... q_{AdS} = 2.26542$  and  $q_{dS} = -0.5586$ , the  $q_{dS}$  value being measured by astrophysical experiments.

Dark energy initiation for  $n=1/2$  then occurs for  $q_{AdS} = 1$  with  $q_{dS} = 1/1 - 1 = 0$

This stipulates a Hubble time  $(1.132712 - 1/2)/H_0 = 0.632712/H_0 = 10.677$  billion years ago for the open AdS spacetime and a Hubble time  $(0.867288 - 1/2)/H_0 = 0.367288/H_0 = 6.198$  billion years ago for the closed and compressed dS spacetime. The cosmological relativistic Doppler redshift is  $z_{DE}=0.6124$  for a Cosmic radiation background temperature of  $4.254 K^*$ .

The compressed dS spacetime is spherically closed and embedded within a spherical dark matter inclusive AdS spacetime. The Riemann hypersphere as a 3-dimensional surface derivative of a 3-sphere of volume  $V_4(R) = 1/2\pi^2 R^4$  in  $dV_4/dR = 2\pi^2 R^3$  geometrically encompasses both interacting spacetimes in the horn torus topology coordinate shifted between the three frequency mirror intervals  $[-1,0]$  intersecting  $[-1/2,+1/2]$  intersecting  $[0,1]$ .

These cosmic mirror-shifted Hubble horizons for the Light Energy universe and the Dark Energy shadow universe are then defined in an overall encompassing closed spherical universe defined by the Particle horizon of the expanding omniverse.

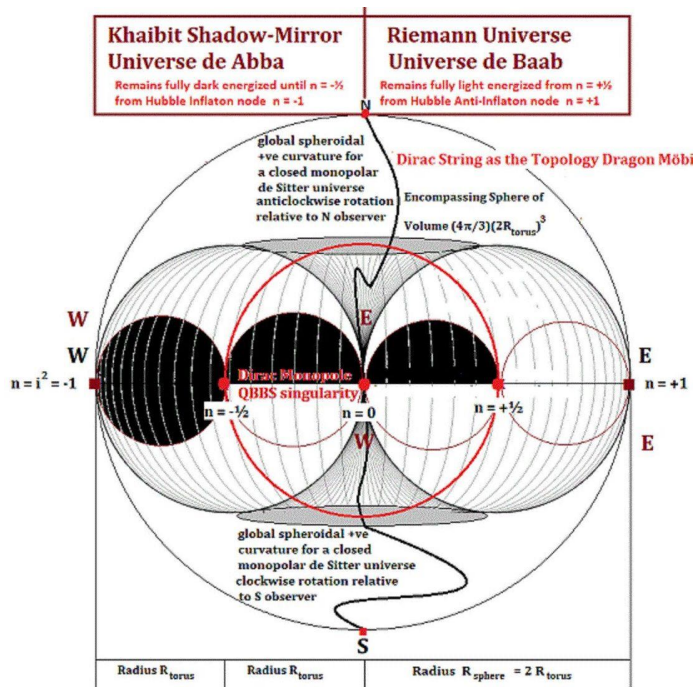

"The idea of an antigravity force has had a bad rep ever since," says Kirshner. "People sort of sniggered when it was mentioned, usually because it meant they couldn't explain their results." So when Riess, having checked his figures, suggested this might be the reason he kept showing negative mass, Kirshner, in quiet desperation, emailed the whole team, saying, "In your heart of hearts, you know this can't be right! We have got to find out where the error is."



"In your heart you know this is wrong." Really, it just seemed like a terrible result, a horrifying thing

GETTING IT RIGHT 219  
the writing assignments. So we all gave him advice. Conflicting advice. After all, this was a collaboration, not an army. I didn't like the result. I didn't think we were smarter than Einstein and he had tripped on the cosmological constant. I did not want to make a mistake. I hadn't liked being wrong about the progenitor of SN 1987A and I did not want to be wrong about the history of cosmic expansion. On 12 January 1998 (at 10:18:31 A.M.) I wrote,

I am worried that the first cut looks like you might need some handbids. In your heart, you know this is wrong, though your head tells you that you don't care and you're just reporting the observations. ... It would be very silly to say "we MUST have nonzero lambda" only to retract it next year.

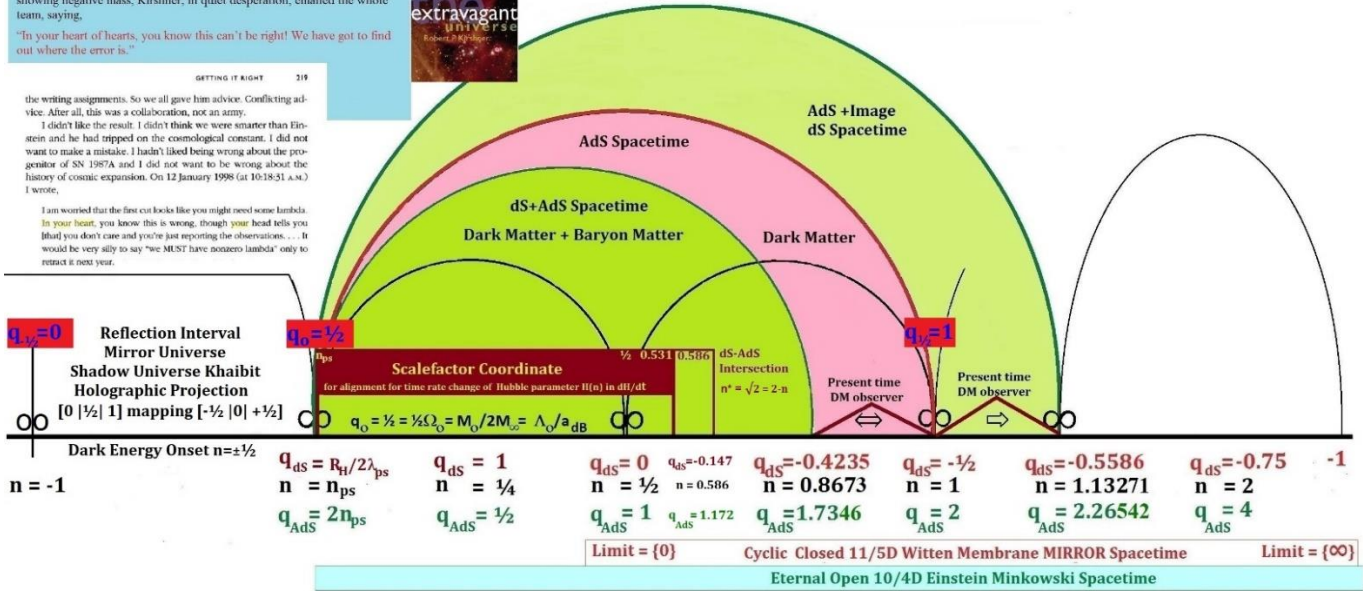

Deceleration Parameter  $q(n) = -[d^2a/dt^2]/[a]/(da/dt)^2$   
 $q_{AdS}(n) = -(2cH_0/[n+1]^2)[nR_0/[n+1]]/[c/(n+1)]^2 = 2nH_0R_0/c = 2n$   
 $q_{AdS}(n) = 1/q_{AdS} - 1 = 1/2n - 1 = (1-2n)/2n$

$q_{dS} = 1/2n - 1$   
 $q_{AdS} = 2n$

$\Lambda(n) = G_0 M_0 / R(n)^2 - 2cH_0/[n+1]^2$   
 $\Lambda(n)/R(n) = G_0 M_0 / R(n)^3 - 2H_0^2/[n][n+1]^2$   
 $-P(n) = \frac{M_0 c^2}{R(n)^3} - \frac{(2n+1)^2 H_0^2}{4n G_0 T(n)^2}$

$q_{dS} \cdot q_{AdS} = 2n(1/2n - 1) = 1 - 2n$

$\frac{q_{dS} + q_{AdS}}{q_{dS} - q_{AdS}} = \frac{1 - 2n + 4n^2}{1 - 2n - 4n^2} = \frac{4\{n^{-1/4}(1+i\sqrt{3})\} \cdot \{n^{-1/4}(1-i\sqrt{3})\}}{-4\{n^{-1/4}(1-\sqrt{5})\} \cdot \{n^{-1/4}(1+\sqrt{5})\}}$

$\{q_{dS} + q_{AdS}\}$  are  $1/2$  roots for  $T(n)=1$  in  $n(n+1)+1=0$   
 $n = -1/4(1+i\sqrt{3})$  ;  $n = -1/4(1-i\sqrt{3})$   
 $\{q_{dS} q_{AdS}\}$  are  $1/2$  roots for  $T(n)=-1=i^2$  in  $n(n+1)-1=0$   
 $n = 1/4(\sqrt{5}-1) = 1/2X$  ;  $n = -1/4(\sqrt{5}+1) = -1/2Y$

The cosmological observer is situated simultaneously in 10/4D Minkowski Flat dS spacetime, presently at the  $n=0.8676$  cycle coordinate and in 11/5D Mirror closed AdS spacetime, presently at the  $n=1.1327$  coordinate.

Observing the universe from AdS will necessarily result in measuring an accelerating universe; which is however in continuous deceleration in the gravitationally compressed dS spacetime for deceleration parameter  $q_{AdS}=2n$ . Gravitation is made manifest in the dS spacetime by Graviton strings from AdS spacetime as Dirichlet branes at the 10D boundary of the expanding universe mirroring the 11D boundary of the nodally fixed Event Horizon characterised by  $H_0 = c/R_H$

The Dark Matter region is defined in the contracting AdS lightpath, approaching the expanding dS spacetime, but includes any already occupied AdS spacetime. The Baryon seeded Universe will intersect the 'return' of the inflaton lighpath at  $n=2-\sqrt{2}=0.586$  for (DM=22.09 %; BM=5.55%; DE=72.36%).

The Dark Energy is defined in the overall critical deceleration and density parameters; the DE being defined in the pressure term from the Friedmann equations and changes sign from positive maximum at the inflaton-instanton to negative in the interval  $\Lambda(n)>0$  for  $n$  in  $[n_{ps} - 0.18023]$  and  $\Lambda(n)> 3.4008$  with  $\Lambda(n)<0$  for  $n$  in  $(0.1803 - 3.4008)$  with absolute minimum at  $n=0.2389$ .

This DE (quasi)pressure term for the present era (1-0.1498 for 85% DM of Matter 4.834% BM; 27.434% DM; 67.732% DE) is  $\Lambda_p = -1.4004 \times 10^{-10} \text{ J/m}^3 < 0 \neq n$  and is integrated into a Lambda quintessence of  $1.039 \times 10^{-36} \text{ s}^{-2}$  and from  $\Lambda(n_p) = -8.815 \times 10^{-11} \text{ m/s}^2$

This pressure term will become asymptotically negative for a universal age of about 57.4 Gy and for a zero curvature evolution of the cosmos within the multiverse generations.

The dimensionless acceleration ratio  $q_0 = \Lambda_0/\Lambda_{dB} = M_0/2M_H = 1/2\Omega_0$  assumes the value  $q_0 = 1/2$  for  $n = 1/3$  and when the radial size of the universe is at halfway nexus at  $1/4 R_H$  for the intersection coordinate between the AdS lightspeed invariant expansion and the Dark Energy onset at redshift  $z = 0.6124$  for the dS gravitationally retarded cosmology and for  $R(1/2) = 1/2 R_H/[1+1/2] = 1/3 R_H$

## Energy Conservation and Continuity

$dE + PdV = TdS = 0$  (First Law of Thermodynamics) for a cosmic fluid and scaled Radius  $R=a.R_0$ ;

$$dR/dt = da/dt.R_0 \text{ and } d^2R/dt^2 = d^2a/dt^2.R_0$$

$$dV/dt = \{dV/dR\}.\{dR/dt\} = 4\pi a^2 R_0^3 .\{da/dt\}$$

$$dE/dt = d(mc^2)/dt = c^2.d\{\rho V\}/dt = (4\pi R_0^3.c^2/3)\{a^3.d\rho/dt + 3a^2\rho.da/dt\}$$

$dE + PdV = (4\pi R_0^3.a^2)\{\rho c^2.da/dt + [kc^2/3].d\rho/dt + P.da/dt\} = 0$  for the cosmic fluid energy pressure continuity equation:

$$d\rho/dt = -3\{(da/dt)/a.\{\rho + P/c^2\}\} \dots\dots\dots[\text{Eq.VII-1}]$$

The independent Einstein Field Equations of the Robertson-Walker metric reduce to the Friedmann equations:

$$H^2 = \{(da/dt)/a\}^2 = 8\pi G\rho/3 - kc^2/a^2 + \Lambda/3 \dots\dots\dots[\text{Eq.VII-2}]$$

$$\{(d^2a/dt^2)/a\} = -4\pi G/3\{\rho + 3P/c^2\} + \Lambda/3 \dots\dots\dots[\text{Eq.VII-3}]$$

for scale radius  $a=R/R_0=R/R_H$ ; Hubble parameter  $H = \{da/dt\}/a$ ; Gravitational Constant  $G$ . Density  $\rho$ ; Curvature  $k$  ; light speed  $c$  and Cosmological Constant  $\Lambda$ .

Differentiating [Eq.VII-2] and substituting [Eq.VII-1] with [Eq.VII-2] gives [Eq.VII-3]

$$\{2(da/dt).(d^2a/dt^2).a^2 - 2a.(da/dt).(da/dt)^2\}/a^4 = 8\pi G.(d\rho/dt)/3 + 2kc^2.(da/dt)/a^3 + 0$$

$$= (8\pi G/3)\{-3\{(da/dt)/a.\{\rho + P/c^2\}\} + 2kc^2.(da/dt)/a^3 + 0$$

$$(2(da/dt)/a^2).\{(d^2a/dt^2) - (da/dt)^2\}/a^3 = (8\pi G/3)\{-3(da/dt)/a.\{\rho + P/c^2\} + 2\{(da/dt)/a\}.(kc^2/a^2) + 0$$

$$(d^2a/dt^2)/a - (da/dt)^2/a^2 = (d^2a/dt^2)/a - 8\pi G\rho/3 + kc^2/a^2 - \Lambda/3 = -4\pi G\{\rho + P/c^2\} + kc^2/a^2$$

$$(d^2a/dt^2)/a = 4\pi G/3\{2\rho - 3\rho - 3P/c^2\} - kc^2/a^2 + \Lambda/3 + kc^2/a^2 = -4\pi G/3\{\rho + 3P/c^2\} + \Lambda/3$$

$$d\{H^2\}/dt = 2H.dH/dt = 2\{(da/dt)/a\}.dH/dt$$

$$\text{with } dH/dt = \{(d^2a/dt^2)/a - H^2\} = (d^2a/dt^2)/a - (da/dt)^2/a^2$$

$$dH/dt = -4\pi G/3\{\rho + 3P/c^2\} + \Lambda/3 - 8\pi G\rho/3 + kc^2/a^2 - \Lambda/3\} = -4\pi G\{\rho + P/c^2\} + kc^2/a^2$$

$dH/dt = -4\pi G\{\rho + P/c^2\}$  as the Time derivative for the Hubble parameter  $H$  for flat Minkowski space-time with curvature  $k=0$  and with a cancelling integrated cosmological constant  $\Lambda/3$  in derivative  $dH/dt$

$$dH/dt = \{(d^2a/dt^2).a - (da/dt)^2\}/a^2 = -4\pi G\{\rho + P/c^2\} + (kc^2/a^2)$$

$$\text{for } (kc^2/a^2) = 8\pi G\rho/3 - H^2 + \Lambda/3 = 0 \text{ for integrated } \Lambda/3 = 0 \text{ and } \rho_{\text{critical}}$$

For a scale factor  $a=R(n)/R_H=n/[n+1] = \{1-1/[n+1]\} = 1/\{1+1/n\}$

$$dH/dt + 4\pi G\rho = -4\pi G\rho/c^2 \dots \text{ (for } V_{4/10D}=[4\pi/3]R_H^3 \text{ and } V_{5/11D}=2\pi^2R_H^3 \text{ in factor } 3\pi/2)$$

Scale factor modulation at  $N_k = \{[n - \sum \prod n_{k-1}] / \prod n_k\}$  for  $R(n)_{ds} = \frac{1}{2}R(n)_{Ads}$  for  $n=1, k=0$

$$\{dH/dt\} = d\{H_0/T(n)\}/dt = -H_0^2(2n+1)/T(n)^2 \text{ for } k=0 \text{ and } n_{-1}=0 \text{ and } n_0=1$$

$$dH/dt + 4\pi G\rho = -4\pi G P/c^2 \text{ for integrated Pressure } P(t) = -c^2\{(dH/dt)/4\pi G + \rho(t)\}$$

$$G_0\rho = G_0M_0/R(n)^3 = -G_0P/c^2 - (dH/dt)/4\pi = \Lambda(n)/R(n) + 2cH_0/R(n)[n+1]^3 \text{ for Volume } V_{ds} = 4\pi R(n)^3/3$$

$$-P(t) = \{c^2/G_0\}\{\Lambda(n)/R(n) + 2cH_0/R(n)[n+1]^3 + (dH/dt)/4\pi\}$$

$$= \{c^2/G_0\}\{\Lambda(n)[n+1]/nR_H + 2H_0^2/n[n+1]^2 - H_0^2(2n+1)/4\pi T(n)^2\}$$

$$P(n=H_0t) = \{c^2H_0^2/4\pi G_0T(n)^2\}\{2n+1-8\pi n+8\pi n\} - M_0c^2/R(n)^3 = c^2H_0^2(2n+1)/4\pi G_0T(n)^2 - M_0c^2/R(n)^3$$

$$P(n=H_0t) = c^2H_0^2(2n+1)/\{4\pi G_0T(n)^2\} - M_0c^2/R(n)^3 \text{ for the spherical } V_{ds} = 4\pi R(n)^3/3$$

$$P(n=H_0t) = c^2H_0^2(2n+1)/\{6\pi^2G_0T(n)^2\} - M_0c^2/R(n)^3 \text{ for the hyper-spherical } V_{ds} = 2\pi^2R(n)^3$$

$P(n,t) < 0$  for an integrated Pressure coordinate maximum for the interval  $[n_{ps} \rightarrow 0]$  for  $[-3 \times 10^{134} \rightarrow 0]$

$$M_0c^2/R(n)^3 = c^2H_0^2(2n+1)/\{4\pi G_0T(n)^2\} \text{ for } R_H/2\pi R_{sarkar} = M_H/2\pi M_0 = [n+1]^5/[2n^2+n] = 1/\Lambda_P(n)$$

$$\text{for } 2\pi\Omega_0 = 0.176117... = \Lambda_P(n) = [2n^2+n]/[n+1]^5 = n[2n+1]/[n+1]^5 \text{ for Volume } V_{ds} = 4\pi R(n)^3/3$$

$$\text{for } 3\pi^2\Omega_0 = 0.829935... = \Lambda_P(n) = [2n^2+n]/[n+1]^5 = n[2n+1]/[n+1]^5 \text{ for Volume } V_{ds} = 2\pi^2R(n)^3$$

$P(n=n_{ps}) = -3 \times 10^{134}$  for  $\Lambda_P(n) = n_{ps} = \lambda_{ps}/R_H = 2\pi r_{ps}/R_H = 6.2590935 \times 10^{-49}$  for  $k=1$  universe reset  $r_{ps}Y^n = R_H$  for cycle reset coordinate  $n_{reset} = \ln(R_H/r_{ps})/\ln Y = \ln(2\pi/n_{ps})/0.48121146 = 234.4715$

$$P(n=n_{ps}) = -3 \times 10^{134} [J/m^3]^* \text{ for } \Lambda_P(n) = n_{ps} = 6.2591 \times 10^{-49}$$

$$P(n_{\Lambda_0}=0.1083) = -2.3761 \times 10^{-8} [J/m^3]^* \text{ for } \Lambda'_P(n) = 0.078793$$

$$P(n_{\Lambda_{Pmax}}=0.40825) = -3.939 \times 10^{-9} [J/m^3]^* \text{ for } \Lambda'_P(n)=0.13389451796$$

$$\text{with } 2\pi\Omega_0 = 2\pi M_0/M_H = 4\pi G_0M_0/c^2R_H$$

$$P(n_{DE=1/2}) = -2.7264 \times 10^{-10} [J/m^3]^* \text{ for } \Lambda'_P(n) = 0.13168724...$$

$$P(n_{H_0=1}) = -1.4976 \times 10^{-10} [J/m^3]^* \text{ for } \Lambda'_P(n) = 0.0937500$$

$$P(n=1.132712) = -1.4004 \times 10^{-10} [J/m^3]^* \text{ for } \Lambda'_P(n) = 0.0938113...$$

$$P(n=234.4715) = -4.0541 \times 10^{-11} [J/m^3]^* \text{ for } \Lambda'_P(n) = 1.5221 \times 10^{-7}$$

For  $\Lambda'_P = 0$  the integrated negative pressure maximum coordinate for  $M_0c^2/R(n)^3 = \Lambda'_P(n)=0.40825$  for the derivative of  $\Lambda'_P(n)=(2n^2+n)/[n+1]^5 = 0.13389451796$  for  $d\{\Lambda'_P(n)\}/dn = 0$

$$\text{for } \Lambda''_P(n) = (4n+1)/[n+1]^5 - 5n(2n+1)/[n+1]^6 = 0 \text{ for } n=1/\sqrt{6} = 0.40825$$

Showing that the Pressure P would be 0 for this coordinate were it not integrated in the Lambda tensor

$\Lambda(0.40825)(R(0.40825)) = (41.04504)G_oM_o/R_H^3 - (2.47027)H_o^2 = (2.0282 - 8.70985)\times 10^{-36} [1/s^2]^*$  for a negative Einstein quintessence of  $-6.68165\times 10^{-36} [1/s^2]^*$  or  $\Lambda(0.40825) = \{9.3941 - 40.3402\}\times 10^{-11} = -3.0946\times 10^{-10} [ms^{-2}]^*$

$\rightarrow P(n,t) = c^2H_o^2(1.8165)/\{4\pi G_o(0.33053)\} - M_o c^2/R(n)^3 = (1.2490 - 1.6429)\times 10^{-9} = -3.939\times 10^{-10} [J/m^3]^*$  for the spherical  $V_{ds} = 4\pi R(n)^3/3 [N/m^2]^*$  as the Lambda integrated pressure at 6.891 billion years after the QBBS as  $P(n=0.40825)$  to define a maximum  $2\pi\Omega_o = 2\pi M_o/M_H$  in the baryon matter seedling with  $P'(0.40825) = -2.3844\times 10^{-26} [J/m^3s]^*$

**For  $\Lambda(n=n_{ps} = |\lambda_{ps}/R_H|_{mod}) = G_oM_o/\lambda_{ps}^2 = 2.015\times 10^{85} [m/s^2]^*$  and  $n_{ps} = \lambda_{ps}/R_H$  as min-max scale boundaries**

$\rightarrow P(n,t) = M_H f_{ps}^2/R_H\{1/2\pi - \Omega_o/n_{ps}\} = 3.645\times 10^{87}\{1/2\pi - 4.478\times 10^{46} [N/m^2]^* O\{-1.63\times 10^{134}\} < 0$   
for a spherical  $V_{ds} = 4\pi R(n_{ps})^3/3 = 4.18879\times 10^{-66} [m^3]^*$  for a boundary and initiation redshift  $z \sim 2\times 10^{24}$  of the instanton-inflaton QBBS with  $\rightarrow dP(n,t)/dt = P'(n,t) = \{-2c^5/4\pi G_o\lambda_{ps}^3\} - \{3M_o c^3/\lambda_{ps}^4\}$   
 $= \{-f_{ps}^3\}\{3M_o/\lambda_{ps} + c^2/2\pi G_o\} = \{-f_{ps}^3\}\{5.44\times 10^{73} - 1.29\times 10^{26}\} < 0$  for  $O(-1.47\times 10^{165}) [J/m^3s]^*$

**For  $\Lambda = 0$  the onset of the Einstein quintessence changing from positive to negative for  $n=0.10823$**

$\Lambda(n_o)(R(n_o)) = (1073.61)G_oM_o/R_H^3 - (84.56)H_o^2 = (5.3053 - 5.3053)\times 10^{-35} [1/s^2]^*$  for a negative Einstein quintessence of  $0 [1/s^2]^*$  for  $\Lambda(n_o) = \{8.2774 - 8.2774x\}\times 10^{-10} = 0 [ms^{-2}]^*$   
 $\rightarrow P(n,t) = c^2H_o^2(1.21646)/\{4\pi G_o(0.01439)\} - M_o c^2/R(n)^3 = (1.9212 - 4.2973)\times 10^{-8} = -2.3761\times 10^{-8} [N/m^2]^*$  for the spherical  $V_{ds} = 4\pi R(n)^3/3 [N/m^2]^* \rightarrow P'(n,t) = -2.6908\times 10^{-24} [J/m^3s]^*$

**For the onset of dark energy for deceleration parameter product  $q_{Ads}\cdot q_{ds} = 2(\frac{1}{2})(1/1-1) = 0$  for  $n=\frac{1}{2}$**

$\Lambda(n_{DE})/(R(n_{DE})) = (27)G_oM_o/R_H^3 - (16/9)H_o^2 = (1.3342 - 6.2680)\times 10^{-36} [1/s^2]^*$  for a negative Einstein quintessence of  $-4.9339\times 10^{-36} [1/s^2]^*$  for  $\Lambda(n_{DE}) = -2.6276\times 10^{-10} [ms^{-2}]^*$   
 $\rightarrow P(n,t) = c^2H_o^2(2)/\{4\pi G_o(9/16)\} - M_o c^2/R(n)^3 = (8.0807 - 10.8071)\times 10^{-10} = -2.7264\times 10^{-10} [N/m^2]^*$  for the spherical  $V_{ds} = 4\pi R(n)^3/3 [N/m^2]^* \rightarrow P'(n,t) = -1.4692\times 10^{-26} [J/m^3s]^*$

**For the completion of the AdS Lightpath at the 1<sup>st</sup> odd Hubble node  $H_o = c/R_H$  for  $n=1$**

$\Lambda(1)/(R(1)) = (8)G_oM_o/R_H^3 - (8/9)H_o^2 = (1.3342 - 3.1341)\times 10^{-36} [1/s^2]^*$  for a negative Einstein quintessence of  $-1.8000\times 10^{-36} [1/s^2]^*$  for  $\Lambda(1) = -1.4378\times 10^{-10} [ms^{-2}]^*$   
 $\rightarrow P(n,t) = c^2H_o^2(3)/\{4\pi G_o(4)\} - M_o c^2/R(n)^3 = (1.7045 - 3.2021)\times 10^{-10} = -1.4976\times 10^{-10} [N/m^2]^*$  for the spherical  $V_{ds} = 4\pi R(n)^3/3 [N/m^2]^* \rightarrow P'(n,t) = -1.6486\times 10^{-27} [J/m^3s]^*$

**For the present time  $n=1.132712$**

$\Lambda(n_{present})/(R(n_{present})) = G_oM_o/R_H^3(n/[n+1])^3 - 2nH_o^2/T(n)^2 = (3.2984 - 13.686)\times 10^{-37} [1/s^2]^*$  for a negative Einstein quintessence of  $-1.08387\times 10^{-36} [1/s^2]^*$  for  $\Lambda(n_{present}) = -8.8143\times 10^{-11} [ms^{-2}]^*$   
 $\rightarrow P(n,t) = c^2H_o^2(3.2654)/\{4\pi G_o(5.8358)\} - M_o c^2/R(n)^3 = (1.2713 - 2.6717)\times 10^{-10} = -1.4004\times 10^{-10} [J/m^3]^*$  for the spherical  $V_{ds} = 4\pi R(n)^3/3 [N/m^2]^* \rightarrow P'(n,t) = -1.1223\times 10^{-27} [J/m^3s]^*$

**For the quantum tunneling of the asymptotic protoverse into the first universe for n=234.4715**

$$\Lambda(n_{\text{quantumtunnel}})/(R(n_{\text{quantumtunnel}}) = G_0 M_0 / R_H^3 (n/[n+1])^3 - 2nH_0^2 / T(n)^2 = 5.0051 \times 10^{-38} - 5.4241 \times 10^{-43}$$

$$= O(5 \times 10^{-38}) [1/s^2]^* \text{ for a positive Einstein quintessence of } 5.0051 \times 10^{-38} [1/s^2]^*$$

$$\text{for } \Lambda(n_{\text{quantumtunnel}}) = 7.9624 \times 10^{-12} [ms^{-2}]^*$$

$$\rightarrow P(n,t) = c^2 H_0^2 (469.943) / \{4\pi G_0 (3.0483 \times 10^9)\} - M_0 c^2 / R(n)^3 = (3.5037 \times 10^{-17} - 4.0541 \times 10^{-11})$$

$$= -4.0541 \times 10^{-11} [N/m^2]^* \text{ for the spherical } V_{dS} = 4\pi R(n)^3 / 3 [N/m^2]^* \rightarrow P'(n,t) = -4.1371 \times 10^{-33} [J/m^3 s]^*$$

**Baryon Matter, Dark Matter and Dark Energy distribution in  $\Omega_{BM} + \Omega_{DM} + \Omega_{DE} = 1 = \Omega_0 f(n) + \Omega_{DE}$   
 $\Omega_{DE} < 0$  for  $n < n_{DE=0}$  and  $\Omega_{DE} = 0$  for  $n = n_{DE=0}$  and  $\Omega_{DE} > 0$  for  $n > n_{DE=0}$**

The density ratio  $\rho_{BMUDM} / \rho_{\text{critical}} = M_0 Y^n R_H^3 / M_H R_H^3 (n/[n+1])^3 = \Omega_0 Y^n \{1+1/n\}^3 = \Omega_0 f(n) = \Omega_{BM} \{1+1/n\}^3$

$$\rho_{BMUDM} / \rho_{\text{critical}} + \Omega_{DE} = 1 = \Omega_0 f(n) + \Omega_{DE} = \Omega_{BM} \{1+1/n\}^3 + \Omega_{DE}$$

For  $\Omega_{DM} = \Omega_{BM} \{1 + 1/n\}^3 - 1 = \Omega_0 (1.618033)^{1.132712} \{5.67480\} = \{0.048344\} \{5.67480\} = 0.274344$  and  
 $\Omega_{DE} = 1 - \Omega_{DM} - \Omega_{BM} = 1 - \Omega_{BM} \{1+1/n\}^3 = 1 - 0.048344 \{6.67480\} = 0.677313$  for the present time

**$\Omega_{BM} = 0.048344$  with  $\Omega_{DM} = 0.274344$  with  $\Omega_{DE} = 0.677313$**

For  $n < n_{DE=0}$  the quintessential DE fraction is negative and subtracted from the Dark Matter fraction.

The Dark Energy DE onset as a correlation between the scale factors  $a(n=1/2) = R(n,t)/R_H = n/[n+1] = 1/2$  and  $a(n=1) = R(n,t)/R_H = n/[n+1] = 1/2$  then synchronizes the intersection interval between the closed compressed dS spacetime and the uncompressed open AdS spacetime in the intersecting twinned universe in the interval  $[-1/2 | 0 | +1/2]$  as imaged half cycles as a full cycle  $[0+n_{ps}, +1]$  imaged in  $[-1, 0-n_{ps}]$ .

For the DE to be 0 the density ratio  $\rho_{BMUDM} / \rho_{\text{critical}} = 1$  describing the Sarkar mass seedling  $M_0$  to increase quintessentially by the BM-DM intersection, saturated at  $n=\sqrt{2}$  for constant  $\Omega_{BM}$  to the closure value  $M_H$  as  $\Omega_0=1$ .

$\Omega_0 Y^n \{1+1/n\}^3 = 1$  for root  $n_{i+1} = n_i - f(n_i) / f'(n_i)$  by a Newton-Raphson approximation  
for  $f(n) = \Omega_0 \exp[n \ln Y] \{1+1/n\}^3 - 1 = 0$  and  $f'(n) = \Omega_0 \exp[n \ln Y] \{1+1/n\}^2 \{(\ln Y [1+1/n] - 3/n^2)$

For  $n_1=1/2$ ;  $n_2 = 1/2 - f(1/2) / f'(1/2) = 1/2 - (27\Omega_0 Y^{1/2} - 1) / (9 \Omega_0 Y^{1/2} \{3 \ln Y - 12\}) = 1/2 - (-0.037323) / (-3.387457) = 0.488982$   
converging to  $n_{DE=0} = 0.489365... = 1/2 - 0.010635$  and as  $\Delta n / H_0 = \Delta n R_H / c = \Delta t = 179.48$  million years as the quantum extremal surface wall for the Page Time in the resolution of the Hawking Information Paradox and as the transition period from the onset of the dark energy 8.258 billion years from the QBBS to 8.438 billion years as the scale factor  $a(1)=R(n)/R_H=1/2$ .

This synchronizes the nodal  $H_0=c/R_H$  frequency with the halfway marker for the AdS Lightpath  $nR_H/R_H=1/2$  meeting the dS Lightpath in the inflaton reversed and nodal mirror EMMR reflection.



## The Great Black Hole Information Escape

As black holes radiate, information appears to be lost. But this can be avoided if the “entanglement entropy” of the radiation rises then falls. Recent calculations have shown how this happens via a “quantum extremal surface” that appears just inside the black hole’s event horizon. Everything inside of this surface is suddenly not part of the black hole. Exactly how this happens, and what it all means, is still an enormous mystery.

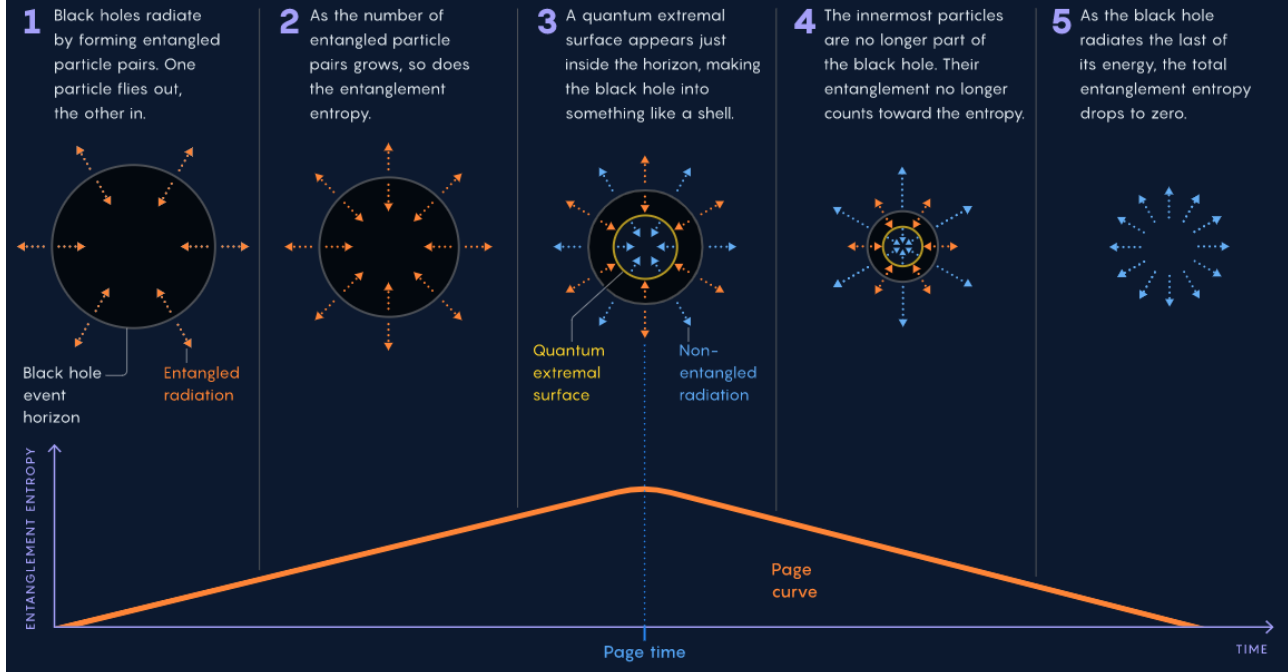

For  $n=n_{ps}$  the mass-energy % distribution  $\Omega_o = \Omega_{BM} + \Omega_{DM} + \Omega_{DE} = (2.803 + 97.197)$  in  $(1.14 - 1.14) \times 10^{145}$

For  $n=0.014015$  the mass-energy % distribution  $\Omega_o = \Omega_{BM} + \Omega_{DM} + \Omega_{DE} = (2.822 + 97.178)$  in  $(1.06 - 1.06) \times 10^6$

For  $n=0.02803$  the mass-energy % distribution  $\Omega_o = \Omega_{BM} + \Omega_{DM} + \Omega_{DE} = (2.841 + 140,158.774 - 140,061.615)$

For  $n=0.10823$  the mass-energy % distribution  $\Omega_o = \Omega_{BM} + \Omega_{DM} + \Omega_{DE} = (2.953 + 3167.261 - 3070.214)$

For  $n=0.2389$  the mass-energy % distribution  $\Omega_o = \Omega_{BM} + \Omega_{DM} + \Omega_{DE} = (3.144 + 435.397 - 338.541)$

**For  $n=0.489365$  the mass-energy % distribution  $\Omega_o = \Omega_{BM} + \Omega_{DM} + \Omega_{DE} = (3.547 + 96.453 + 0)$**

For  $n=0.49$  the mass-energy % distribution  $\Omega_o = \Omega_{BM} + \Omega_{DM} + \Omega_{DE} = (3.548 + 96.211 + 0.241)$

**For  $n=1/2$  the mass-energy % distribution  $\Omega_o = \Omega_{BM} + \Omega_{DM} + \Omega_{DE} = (3.565 + 92.703 + 3.732)$**

**For  $n=1$  the mass-energy % distribution  $\Omega_o = \Omega_{BM} + \Omega_{DM} + \Omega_{DE} = (4.535 + 31.748 + 63.717)$**

**For  $n=1.132712$  the mass-energy % distribution  $\Omega_o = \Omega_{BM} + \Omega_{DM} + \Omega_{DE} = (4.834 + 27.434 + 67.732)$**

For  $n=\sqrt{2}$  the mass-energy % distribution  $\Omega_o = \Omega_{BM} + \Omega_{DM} + \Omega_{DE} = (5.536 + 22.004 + 72.460)$

For  $n=2$  the mass-energy % distribution  $\Omega_o = \Omega_{BM} + \Omega_{DM} + \Omega_{DE} = (5.536 + 3.924 + 90.540)$

For  $n=234.4715$  the mass-energy % distribution  $\Omega_o = \Omega_{BM} + \Omega_{DM} + \Omega_{DE} = (5.536 + 0.071 + 94.393)$

As  $G_0 M_0 = G(n) X^n M(n) Y^n = \text{constant}$  with  $\Omega_0 Y^n = \Omega_{BM}$   $G_0 X^n \cdot Y^n \Omega_0 = G(n) \Omega_{BM}$  for  $2\pi\Omega_0 - \Lambda_{pmax}(n=0.40825)$

$$1 + 2\pi\Omega_0 - \Lambda' |_{max} = G(n_{measured})/G_0 X^n + \delta = \Omega_0 G_m Y^n / \Omega_{BM} G(n) + \delta \text{ for a measured } G_m = G(n_{measured})$$

$$1 + 0.176117 - 0.1338945 + \delta = 1.0422225 + \delta = \{0.02803 Y^n / 0.04834\} Y^n \{G_m\} / G(n)$$

$$= 1.00009 \{G_m / 6.442195 \times 10^{-11}\} \text{ for a monopole derived delta } \delta = 1.0422225 - 1.035428 = 0.006794$$

$$G_m = 6.4416152 \times 10^{-11} \{1.042225 + \delta\} = 6.6698 \times 10^{-11} [\text{m}^3/\text{kg} \cdot \text{s}^2]^* \text{ and } 6.67443 \times 10^{-11} [\text{m}^3/\text{kg} \cdot \text{s}^2]_{SI}$$

The Dark Energy and the 'Cosmological Constant' exhibiting the nature of an intrinsic negative pressure in the cosmology became defined in the overall critical deceleration and density parameters.

The pressure term in the Friedmann equations being a quintessence of function n and changing sign from positive to negative to positive as indicated.

The energy density  $M_0 c^2 / R(n)^3$  as the energy-stress tensor always exceeds Pressure  $P(n,t)$  and its derivative  $dP(n,t)/dt$ .

The encompassing cosmology so is always matter dominated in the sense of the overall energy distribution and the asymptotic zero approach of the integrated negative pressure quintessence.

$$\text{Critical Density } \rho_c = 3H_0^2 / 8\pi G_0 \text{ dS with } \rho_c = H_0^2 / 4\pi^2 G_0 \text{ AdS in factor } 3\pi/2$$

$$\text{for } H(n)^2 = \{da/dt\}^2 / a^2 = \{c^2 / [n+1]^4\} / \{n^2 R_H^2 / [n+1]^2\} = H_0^2 / n^2 [n+1]^2 = H_0^2 / T(n)^2$$

for  $\{da/dt\}^2 = 8\pi G_0 \rho_c a^2 / 3$  dS and  $\{da/dt\}^2 = 4\pi^2 G_0 \rho_c a^2$  AdS for spherical closure dS in omnispaces as a function of the Particle Hubble event horizon of the nodal cosmology for critical density  $\rho_{critical}$  and curvature radius  $R_{curv} = 2G_0 M_H / c^2$  and scale factor  $a(n,t) = R(n,t) / R_H$

$$\int da/a = \int \sqrt{\{8\pi G_0 \rho_c / 3\}} dt \text{ dS and } \int da/a = \int \sqrt{\{4\pi^2 G_0 \rho_c\}} dt \text{ AdS}$$

$$\text{for } \ln\{a\} = \sqrt{\{8\pi G_0 \rho_c / 3\}} t \text{ dS and } \ln\{a\} = \sqrt{\{4\pi^2 G_0 \rho_c\}} t \text{ AdS}$$

$$\text{for } a(t) = \exp[\sqrt{\{8\pi G_0 \rho_c / 3\}} t] = \exp[H_0] \text{ dS and } a(t) = \exp[\sqrt{\{4\pi^2 G_0 \rho_c\}} t] = \exp[H_0] \text{ AdS}$$

This correlates with a generalised density  $\rho(n=H_0 t)$  varying cosmology, often modelled as a flat matter only de Sitter universe with scale factor  $a(n,t) = R(n) / R_H = R(n) H_0 / c \propto t^{2/3}$

$$H(n) = \{(dR(t)/dt) / R_H\} / \{R(t) / R_H\} = \sqrt{\{8\pi G_0 \rho(n,t) / 3\}} = \sqrt{\{8\pi G_0 (M(n,t) / 3R(n,t)^3)\}} \text{ dS and}$$

$$H(n) = \{(dR(t)/dt) / R_H\} / \{R(t) / R_H\} = \sqrt{\{4\pi^2 G_0 \rho(n,t)\}} = \sqrt{\{4\pi^2 G_0 (M(n,t) / R(n,t)^3)\}} \text{ AdS}$$

$$\text{For } \sqrt{R(t)} \cdot dR(t) = \sqrt{\{8\pi G_0 (M(n,t) / 3)\}} \cdot dt \text{ dS and } \sqrt{R(t)} \cdot dR(t) = \sqrt{\{4\pi^2 G_0 (M(n,t))\}} \cdot dt \text{ AdS}$$

$$\text{For } \sqrt[2]{3} R(t)^{1.5} = \sqrt{\{8\pi G_0 (M(n,t) / 3)\}} t \text{ and } R(t) = \sqrt[3]{\{6\pi G_0 (M(n,t))\}} t^{2/3} \text{ dS and}$$

$$\text{for } \sqrt[2]{3} R(t)^{1.5} = \sqrt{\{4\pi^2 G_0 (M(n,t))\}} t \text{ and } R(t) = \sqrt[3]{\{9\pi^2 G_0 (M(n,t))\}} t^{2/3} \text{ AdS within the closed dS omniverse}$$

For AdS encompassing the cyclic dS protoverse as a multiverse as a closed dS spacetime, the scale factor is  $a=n=H_0t$  for  $dn/dt=H_0$  for the Particle Horizon and closure  $n=1$  for  $M(n,t)=M_H=R_{\text{curv}}c^2/2G_0$  with

$$nR_H=R(n,t) = \sqrt[3]{\{6\pi G_0(M(n,t))\} [n/H_0]^{2/3}} \quad dS \text{ for } nR_H^3 = \{6\pi G_0(M(n,t)/H_0^2)\} = 9M(n,t)/4\rho_c \text{ and} \\ n = 9M(n,t)/4\rho_c R_H^3 = \{9M(n,t)/4R_H^3\}\{4\pi R_H^3/3M_H\} = 3\pi\{R_{\text{curv}}/R_H\} = 3\pi \text{ for } M(n,t) = M_H \text{ and } n=1$$

For the dS omniverse encompassing the cyclic dS protoverse as a multiverse as AdS spacetime in the topology of a horn torus, the scale factor is  $a=n=H_0t$  for  $dn/dt=H_0$  for the Particle Horizon and closure  $n=1$  for  $M(n,t)=M_H=R_{\text{curv}}c^2/2G_0$  with

$$nR_H=R(n,t) = \sqrt[3]{\{9\pi^2 G_0(M(n,t))\} [n/H_0]^{2/3}} \quad dS \text{ for } nR_H^3 = \{9\pi^2 G_0(M(n,t)/H_0^2)\} = 9M(n,t)/4\rho_c \text{ and} \\ n = 9M(n,t)/4\rho_c R_H^3 = \{9M(n,t)/4R_H^3\}\{2\pi^2 R_H^3/M_H\} = 9\pi^2/2 \text{ for } M(n,t) = M_H \text{ and cycle } n=1$$

The time for closure so becomes about one third the Hubble time  $1/H_0 = R_H/c$  in

$$t^2 = R_H^3/6\pi G_0 M_H = R_H/3\pi H_0^2 R_{\text{curv}} = 1/3\pi H_0^2 \text{ for a time } t=1.73473 \times 10^{17} \text{ s}^* \text{ or } n=0.32573 \text{ or } 5.4971 \text{ Gy, when} \\ R(t=n/H_0) = 3.9253 \times 10^{25} \text{ m}^* = 0.2457 R_H$$

For a present measured deceleration parameter  $q_{\text{dS}}=-0.5586$ , the DE Lambda as the negative Einstein quintessence calculates as  $-8.8143 \times 10^{-11} \text{ [m/s}^2\text{]}^*$  or as  $1.0388 \times 10^{-36} \text{ [s}^{-2}\text{]}^*$  and as a negative pressure of  $-1.4004 \times 10^{-10} \text{ [N/m}^2\text{]=J/m}^3\text{]}^*$  as a function of the native universal Milgröm deceleration  $a_{\text{mil}} = -2H_0^2 R_H/[n+1]^3 = -1.1614 \times 10^{-10} \text{ [m/s}^2\text{]}^*$ .

The Einstein Lambda then becomes the energy-acceleration difference between the baryonic mass content of the universe and an inherent mass energy related to the initial condition of the oscillation parameters for the nodal Hubble Constant.

For  $\Omega(n) = M(n)/M_H = 2q_0 = 1 = R(n)/R_H$  the AdS cosmology attains closure for a cycle coordinate  $n=1$  in the EMMR Lightpath and a time, when the dS gravitationally retarded universe has reached the halfway point in its asymptotically defined expansion in scale factor  $R(n,t)/R_H = n/[n+1] = a(n,t)$  in a recessional velocity of the expanding dS wavefront slower than the speed of light.

The dS compressed universe has reached the halfway marker for the onset of the dark energy at a cycle time coordinate of  $n=1$  and when the AdS dark matter inclusive universe has reached the nodal Hubble event horizon as the boundary for the multidimensional cosmology as set in the superluminal Lightpath of the QBBS superimposed onto the parallel evolution of the dS and AdS spacetimes expansion.

The extent of the EMMR Lightpath in AdS so encompasses a full nodal displacement in the interval  $[n_{\text{ps}} \sim 0,1]$  which is phase shifted as the interval  $[-1/2, +1/2]$  to mirror the invariance of the EMR Lightpath relative to the gravitationally retarded EMR Lightpath in the cycle coordinate  $n=1/2$  as a proxy nodal mirror for the true Hubble node at  $n=1$ .

The 'return' of the reflected EMMR Lightpath from the true Hubble event horizon so is made manifest as the EMR Lightpath at the proxy Hubble node at the DE  $n$ -cycle coordinate  $n=1/2$  and for which the deceleration parameter product is zero for  $q_{\text{AdS}} = 2n = 1$  and  $q_{\text{dS}} = 1/q_{\text{AdS}} - 1 = 0$ .

The actual curvature radius for  $n=1/2$  for the dS cosmology is  $R(1/2) = 1/2 \cdot 2/3 R_H = 1/3 R_H$  to indicate that the dark matter portion for the compressed spacetime will be  $1/2^3 - 1/3^3 = 1/8 - 1/27 = 19/108 = 0.0880 = 1/11.36$  in terms of the volume occupied.

For  $n=1$ , the dark matter sector so will be doubled to  $0.1759 = 1/5.6842$  for the ratio between the dS sector without the dark matter and the AdS sector with the dark matter with  $1/6.6842 + 5.6842/6.6842 = 1$  or as so 15% BM and 85% DM as the total matter content of the universe.

The distribution for the present scale factor of  $0.53R_H$  gives  $\Omega_{BM} = \Omega_0 Y^{1.132712} = 0.04834$  and for  $n_{\text{present}}$   $\Omega_{DM} = \Omega_0 \{1 + 1/n\}^3 = 0.2743$  as  $4.834/32.262 = 14.98\%$  and  $27.43/32.262 = 85.02\%$ .

The difference between the AdS curvature radius for  $n=1$  superposed onto the dS curvature radius for  $n=1$  and the actual dS curvature radius for  $n=1/2$  then is  $(1/2 - 1/3)R_H = 1/6 R_H$  for a ratio of  $1/2 R_H / 1/3 R_H = 3/2$

The density parameter  $\Omega = R(n)/R_H = 1$  so triggers the second universe from the lightspeed invariant AdS completion of the Lightpath in the AdS cosmology with the Dark Energy manifesting in potential energy vortices of wormholes defined in the inflaton hyperspace cosmology and superpositioned as the phase shift of the  $[n_{ps}, 1]$  interval in the interval  $[-1/2, +1/2]$  as the dark energy onset.

This defines the Dark Energy onset for the difference between the AdS EMMI  $ct=nR_H$  Lightpath and the dS EMR expansion  $R(n)=nR_H/[n+1]$  as  $R_H\{n - n/[n+1]\} = R_H\{(T(n)-n)/[n+1]\} = n^2 R_H/[n+1] = 1/6 R_H$  for  $n=1/2$

This difference is trivially 0 for the QBBS and  $n=0 \sim n_{ps}$  and is 0 for the intersection coordinate for the stasis of the dark matter part with the baryonic matter part of the energy density for the cyclic return of the EMMI Lightpath  $ct=R_H\{2-n\} > R_H$  with  $\{2-n\}=n/[n+1]$  or  $2-n^2 = 0$  for  $n_{BMUDM} = \sqrt{2}$

For  $n=1$  and the nodal Hubble event horizon the AdS-dS difference  $n^2 R_H/[n+1] = 1/2 R_H$  for  $n/[n+1]$

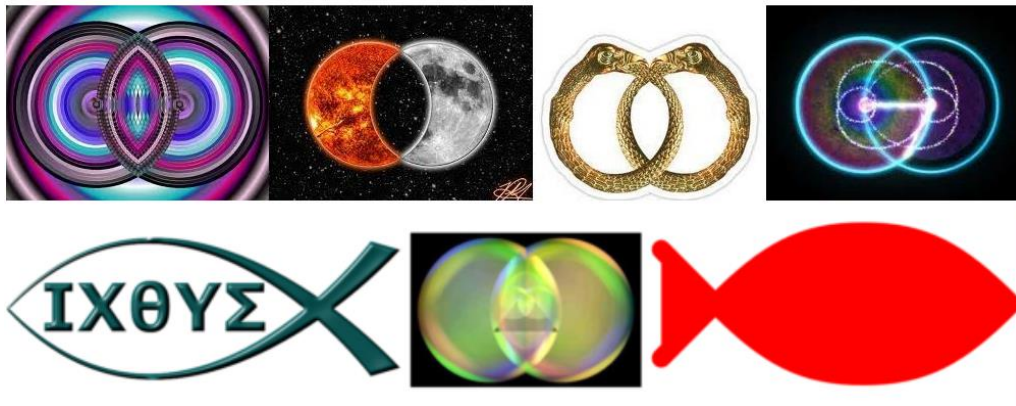

## The Universal Temperature Evolution in light paths EMI and EMMI

$n=H_0 t$ t=	Radius $m^*$ $R(n)=R_0/[n+1]$	Mod factor	Quantum Modulation $E=hc/\lambda$	Cosmological comoving redshift $z+1=v\{1+2/n(n+2)\}$ Energy $J^*/GeV^*$	Temperature CBBR $T = \sqrt[3]{18.2(n+1)^2/n^3}$ of cycle time n $T_{Hawking}/T_{Ylem} = hcR_0^2 / 2\pi G_0 m_p^2 R_{Hawking}^2$ Boson Energy $E=k_B T$	Hawking $\mu BH$ Radius Ylem Radius Hawking Mass	Hawking Temp $T_{Hawking}=hc^3/4\pi k_B G_0 M_{Hawking}$ Ylem Radius $R_{Ylem}=v\{k_B T R_0^2/G_0 m_p^2\}$ Hawking Radius $R_{Hawking}=hc/2\pi k_B T_{Hawking}$ Hawking Mass $M_{Hawking}=R_{Hawking}^2 c^2/2G_0$
1.132711 19.116 Gy	$R_{EMMI}(n_0)=1.80970456 \times 10^{25}$ EMMI $R_{EMI}(n_0)=8.48546550 \times 10^{25}$ EMI	-	-	0.2505 Local Flow	2.7470 K* $3.88 \times 10^{-23}$ $J^*/0.00024$ eV*	8.2081x $10^{-4}$ m* 0.08715 m* 3.32428 $\times 10^{23}$ kg*	Ylem Mass is ~ 5.88 earth masses $T_{Hawking}=T_{Universe}=2.7470$ K* $T_{Ylem}=0.0259$ K* $R_{Ylem}=0.0871$ m* $R_{Hawking}=8.21 \times 10^{-4}$ m* $M_{Hawking}=3.53 \times 10^{25}$ kg* $M_{Curv}=3.32 \times 10^{23}$ kg*
1 16.876 Gy	$R_{EMMI}(1)=1.597675453 \times 10^{25}$ EMMI $R_{EMI}(1)=7.988377266 \times 10^{25}$ EMI	-	-	0.2910 Limit Local flow	2.921 K* $4.12 \times 10^{-23}$ $J^*/0.00026$ eV*	7.7192x $10^{-4}$ m* 0.08986 m* 3.1263x $10^{23}$ kg*	$H_0=58.04$ km/Mpc.s
0.8673 14.637 Gy	$R_{EMMI}(AdS \text{ to } dS)=1.386 \times 10^{25}$ $R_{EMI}(dS \text{ to } AdS)=7.421 \times 10^{25}$	-	-	0.3432	3.140 K* $4.43 \times 10^{-23}$ $J^*/0.00028$ eV*	7.1808x $10^{-4}$ m* 0.09317 m* 2.9082x $10^{23}$ kg*	Measured present age of universe $H(n)=H_0/(2-n_0)=66.92$ km/Mpc.s
1/2 8.438 Gy	$R_{EMMI}(AdS \text{ to } dS)=7.988 \times 10^{25}$ $R_{EMI}(dS \text{ to } AdS)=5.326 \times 10^{25}$	-	-	0.6124	4.254 K* $6.01 \times 10^{-23}$ $J^*/0.00037$ eV*	5.3003x $10^{-4}$ m* 0.10845 m* 2.1466x $10^{23}$ kg*	Onset of dark energy
0.26542 4.479 Gy	$R_{EMMI}(AdS \text{ to } dS)=4.241 \times 10^{25}$ $R_{EMI}(dS \text{ to } AdS)=3.351 \times 10^{25}$	-	-	1.0800	6.283 K* $8.87 \times 10^{-23}$ $J^*/0.00055$ eV*	3.5887x $10^{-4}$ m* 0.13180 m* 1.4534x $10^{23}$ kg*	
0.2389 4.032 Gy	$R_{EMMI}(AdS \text{ to } dS)=3.817 \times 10^{25}$ $R_{EMI}(dS \text{ to } AdS)=3.081 \times 10^{25}$	-	-	1.1770	6.728 K* $9.50 \times 10^{-23}$ $J^*/0.00059$ eV*	3.3513x $10^{-4}$ m* 0.13638 m* 1.3573x $10^{23}$ kg*	Peak of galaxy formation
0.13271 2.240 Gy	$R_{EMMI}(AdS \text{ to } dS)=2.120 \times 10^{25}$ $R_{EMI}(dS \text{ to } AdS)=1.872 \times 10^{25}$	-	-	1.8401	9.998 K* $1.41 \times 10^{-22}$ $J^*/0.00088$ eV*	2.2552x $10^{-4}$ m* 0.16623 m* 9.1336x $10^{22}$ kg*	Image of $n_{present}$

0.10823 1.827 Gy	$R_{\text{Ode}}=1.729 \times 10^{-15}$ EMMI (AdS to dS) $R_{\text{Ode}}=1.560 \times 10^{23}$ EMI (dS to AdS)	-	-	2.1249	11.523 K* $1.63 \times 10^{-22}$ $J^*/0.00101$ eV*	1.9568x $10^{-4}$ m* 0.17849 m* 7.9248x $10^{22}$ kg*	Galaxy formation for Einstein quintessence balanced by Milgröm intrinsic deceleration and $\Lambda_s=0$
0.059255 1 Gy	$R_{\text{Ode}}=9.467 \times 10^{-14}$ EMMI (AdS to dS) $R_{\text{Ode}}=8.937 \times 10^{23}$ EMI (dS to AdS)	-	-	3.1702	17.700 K* $2.50 \times 10^{-22}$ $J^*/0.00156$ eV*	1.2739x $10^{-4}$ m* 0.22121 m* 5.1592x $10^{22}$ kg*	1 <sup>st</sup> Stars from galactic seeds
0.056391 0.95166 Gy	$R_{\text{Ode}}=9.009 \times 10^{-14}$ EMMI (AdS to dS) $R_{\text{Ode}}=8.529 \times 10^{23}$ EMI (dS to AdS)	-	-	3.2717	18.345 K* $2.59 \times 10^{-22}$ $J^*/0.00161$ eV*	1.2291x $10^{-4}$ m* 0.22521 m* 4.9778x $10^{22}$ kg*	Radiation-Matter equilibrium begin star formation
0.0430041 725,742 My	$R_{\text{Ode}}=6.871 \times 10^{-14}$ EMMI (AdS to dS) $R_{\text{Ode}}=6.587 \times 10^{24}$ EMI (dS to AdS)	$3.51 \times 10^{23}$	$R_{\text{ALGO}}=2\pi L_{\text{ALGO}}=5.325$ $58484 \times 10^{-5}$ $L_{\text{ALGO}}=r_{\text{ALGO}}=8.47593$ $\times 10^6$ Universe the size of smallest life bio- organisms; cellular complex	3.8748	22.337 K* $3.15 \times 10^{-22}$ $J^*/0.00196$ eV*	1.0094x $10^{-4}$ m* 0.24851 m* 4.0882x $10^{22}$ kg*	Completion of Inversion Modulation for the Algo wavelength in spacetime from spacetime of supermembrane EpsEss in Sarkar supercluster scale
$2nq_s=0.02$ 803012 473.039 My	$R_{\text{dark}}=2G_s M_s/c^2=4.47$ $830347 \times 10^{24}$	$1.62 \times 10^{23}$	$3.62044 \times 10^5$	5.0152	30.570 K* $4.32 \times 10^{-22}$ $J^*/0.00269$ eV*	7.3757x $10^{-5}$ m* 0.29071 m* 2.9871x $10^{22}$ kg*	dark matter galaxies from supercluster seed manifest honey-comb universal geometry baryon seed $m_{\text{baryon}}=0.02803=M_s/\$ $M_{\text{pl}}=2\Lambda_s/A_{\text{dB}}$
$nq_s=0.014$ 01506 236.520 My	$R_{\text{dark}}=G_s M_s/c^2=2.239$ $15174 \times 10^{24}$	$4.05 \times 10^{19}$	$1.81022 \times 10^5$	7.4777	51.062 K* $7.21 \times 10^{-22}$ $J^*/0.00449$ eV*	4.4157x $10^{-5}$ m* 0.37572 m* 1.7884x $10^{22}$ kg*	Quasar wall - 1 <sup>st</sup> protostars from supercluster seeds Deceleration parameter $q_s=1/2 M_s/M_{\text{pl}}=\Lambda_s/A_{\text{dB}}$
$1/2 nq_s=0.00$ 700753 118.260 My	$R_{\text{dark}}=1/2 G_s M_s/c^2=1.11$ $957587 \times 10^{24}$	$1.01 \times 10^{19}$	$9.0511 \times 10^6$	10.967	85.578 K* $1.21 \times 10^{-21}$ $J^*/0.00752$ eV*	2.6347x $10^{-5}$ m* 0.48641 m* 1.0671x $10^{22}$ kg*	White Hole-Black Hole Sarkar modulation Birth of 1 <sup>st</sup> galaxies like the Milky Way form as baryon seed for dark matter galaxies protostars manifest from ylem white hole-black hole coupling
$3.934 \times 10^{-3}$ 6.63948 My	$r_{\text{ss}}=2\pi \Lambda_{\text{ss}}=6.283 \times 10^{-22}$	$3.19 \times 10^{16}$	$5.07943 \times 10^7$	49.421	358.05 K* $5.05 \times 10^{-21}$ $J^*/0.03146$ eV*	6.2973x $10^{-6}$ m* 0.99494 m* 2.5504x $10^{21}$ kg*	Modular wormhole perimeter White Hole upper limit as wormhole sourcesink $E_{\text{pl}}$ begins to activate as black hole power sourcesink Ess dark matter galaxies geometry

8.659x10 <sup>3</sup> 4.6113x10 <sup>4</sup> 1.46127 My	1.383395x10 <sup>22</sup>	1.55x10 <sup>15</sup>	1.118392x10 <sup>7</sup>	106.468	2301.04 K* 3.25x10 <sup>-20</sup> J*/0.20221 eV*	9.79888 3x10 <sup>-7</sup> m* 2.5222 m* 3.9685x 10 <sup>20</sup> kg*	R <sub>reionizing</sub> =R <sub>e</sub> /α <sup>4</sup> =9.79888 3x10 <sup>-7</sup> m*
6.259x10 <sup>3</sup> 1.05636 My	λ <sub>ax</sub> = 10 <sup>-22</sup>	8.08x10 <sup>14</sup>	8.0844x10 <sup>-8</sup>	125.40	2935.13 K* 4.14x10 <sup>-20</sup> J*/0.25793 eV*	7.6820x 10 <sup>-7</sup> m* 2.84864 m* 3.1112x 10 <sup>20</sup> kg*	Reionization end of opaque universe Baryogenesis and atomic structure
2.303x10 <sup>3</sup> 388,596.8 y	λ <sub>ax</sub> = 10 <sup>-22</sup> /e=3.678794412x 10 <sup>-21</sup>	1.09x10 <sup>14</sup>	2.974085x10 <sup>-8</sup>	207.40	6213.74 K* 8.77x10 <sup>-20</sup> J*/0.54605 eV*	3.6287x 10 <sup>-7</sup> m* 4.14477 m* 1.4696x 10 <sup>20</sup> kg*	Reionization end of opaque attenuated universe
9.962x10 <sup>4</sup> 168,115.7 y	λ <sub>ax</sub> /2π=1.592x10 <sup>-21</sup>	2.05x10 <sup>13</sup>	1.28704x10 <sup>-8</sup>	315.83	11,648.4 K* 1.64x10 <sup>-19</sup> J*/1.0236 eV*	1.9357x 10 <sup>-7</sup> m* 5.67488 m* 7.8395x 10 <sup>20</sup> kg*	macro quantum superstrings as supercluster seeds 168,115 y to 486,681 My; 11,648- 358 K*
6.903x10 <sup>7</sup> 11,649.5 y	1.1028646x10 <sup>-10</sup>	9.83x10 <sup>10</sup>	R <sub>CPV</sub> =2πL <sub>CPV</sub> =8.916x10 <sup>-10</sup> L <sub>CPV</sub> =r <sub>CPV</sub> =1.419x10 <sup>-10</sup> Universe the size of an atom	1202.6	86,246.7 K* 1.22x10 <sup>-18</sup> J*/7.5792 eV*	2.6143x 10 <sup>-6</sup> m* 15.4417 m* 1.0588x 10 <sup>10</sup> kg*	Supermembrane modulation for the Planck length bounce in spacetime from spacetime on a characteristic galaxy scale R <sub>plan</sub> =R <sub>cluv</sub> for M <sub>plan</sub> =6.25x10 <sup>27</sup> kg*/0.003M <sub>sun</sub>
5.897x10 <sup>8</sup> 995.22 y	9.42184766x10 <sup>-18</sup>	7.18x10 <sup>8</sup>	R <sub>PL</sub> =2πL <sub>PL</sub> =7.617x10 <sup>-11</sup> L <sub>PL</sub> =r <sub>PL</sub> =1.212x10 <sup>-11</sup> Universe the size of the Bohr atom scale λ <sub>ax</sub> =R <sub>e</sub> /α <sup>2</sup>	4116.9	545,798.3 K* 7.71x10 <sup>-18</sup> J*/47.964 eV*	4.1311x 10 <sup>-9</sup> m* 38.8454 m* 1.6731x 10 <sup>18</sup> kg*	Supermembrane modulation for the Planck length in spacetime from spacetime on a characteristic galactic core scale R <sub>plan</sub> =R <sub>cluv</sub> for M <sub>plan</sub> =1.57x10 <sup>28</sup> kg*/0.008M <sub>sun</sub>
5.038x10 <sup>8</sup> 85.019 y	8.0488332x10 <sup>-17</sup>	5.24x10 <sup>6</sup>	R <sub>MQ</sub> =2πL <sub>MQ</sub> =6.507x10 <sup>-12</sup> L <sub>MQ</sub> =r <sub>MQ</sub> =1.036x10 <sup>-12</sup> Universe the size of the wave matter de Broglie quantum scale λ <sub>ax</sub> =h/mc	14,087.9	3.4541x10 <sup>6</sup> K* 4.88x10 <sup>-17</sup> J*/303.54 eV*	6.5278x 10 <sup>-10</sup> m* 97.7217 m* 2.6438x 10 <sup>17</sup> kg*	Supermembrane modulation for the maximum monopole scale in spacetime from spacetime on a characteristic galactic core black hole scale R <sub>plan</sub> =R <sub>cluv</sub> for M <sub>plan</sub> =3.96x10 <sup>28</sup> kg*/0.020M <sub>sun</sub>
5.625x10 <sup>10</sup> H <sub>0</sub> c=c <sup>2</sup> /R <sub>H</sub> c s*= 9.51 y	9.008x10 <sup>-16</sup>	65,534	7.275x10 <sup>-13</sup>	42,132.1	1.79x10 <sup>7</sup> K* 2.527x10 <sup>-16</sup> J*/1573 eV*	1.26x 10 <sup>-10</sup> m* 223.46 m* 5.10x10 <sup>16</sup> kg*	QBBS tachyon Lichtpath image as c <sup>2</sup> m*

1.741x10 <sup>11</sup> 2.938 y	2.781058x10 <sup>16</sup>	6252.7	2.24832x10 <sup>13</sup>	75,793.8	4.3217x10 <sup>7</sup> K* 6.10x10 <sup>-16</sup> J*/3.798 keV* Fusion temperatur e Mass limit for star formation	5.2172x 10 <sup>-11</sup> m* 345.661 m* 2.1130x 10 <sup>16</sup> kg*	R <sub>Bohr</sub> =R <sub>e</sub> /α <sup>2</sup> =1 <sup>11</sup> Bohr radius for ylemic template for atomic structure as micro- Hawking black hole to manifest at R <sub>Bohr</sub> /α <sup>3</sup> =9.798883x1 0 <sup>7</sup> m* R <sub>plan</sub> =R <sub>carv</sub> for M <sub>plan</sub> =1.40x10 <sup>23</sup> kg*/0.070M <sub>sun</sub>
1.679x10 <sup>11</sup> 2.834 y	2.6829444x10 <sup>16</sup>	5819.3	R <sub>MD</sub> =2πL <sub>MD</sub> =2.169x1 0 <sup>13</sup> L <sub>MD</sub> =Γ <sub>MD</sub> =3.451x10 <sup>-14</sup> Universe the size of the Compton quantum scale R <sub>Compton</sub> = R <sub>e</sub> /α=ħ/2πmc	77,167.2	4.4277x10 <sup>7</sup> K* 6.25x10 <sup>-16</sup> J*/3.891 keV*	5.0924x 10 <sup>-11</sup> m* 349.874 m* 2.0624x 10 <sup>16</sup> kg*	Supermembrane modulation for the minimum monopole scale in spacetime from spacetime on a characteristic star globular cluster scale R <sub>plan</sub> =R <sub>carv</sub> for M <sub>plan</sub> =1.42x10 <sup>23</sup> kg*/0.071M <sub>sun</sub>
1.608x10 <sup>11</sup> 99.094 days	2πλ <sup>*</sup> =2.568524393x 10 <sup>15</sup> Monopolar upper classical bound	8π <sup>3</sup> λ <sup>*</sup> r * 53.335	4π <sup>2</sup> r <sup>*</sup> =2.07650x10 <sup>-14</sup> Monopolar upper quantum bound	249,402.7	2.5726x10 <sup>7</sup> K* 3.63x10 <sup>-15</sup> J*/22.607 keV*	8.7645x 10 <sup>-12</sup> m* 843.354 m* 3.5496x 10 <sup>15</sup> kg*	R <sub>plan</sub> =R <sub>carv</sub> for M <sub>plan</sub> =3.42x10 <sup>23</sup> kg*/0.171M <sub>sun</sub>
1.496x10 <sup>11</sup> 92.203 days	2.389899x10 <sup>15</sup>	46.175	1.93209x10 <sup>-14</sup>	258,554.9	2.7155x10 <sup>7</sup> K* 3.83x10 <sup>-15</sup> J*/23.863 keV*	8.3034x 10 <sup>-12</sup> m* 866.452 m* 3.3629x 10 <sup>15</sup> kg*	R <sub>Bohr</sub> =R <sub>e</sub> /2πα <sup>2</sup> =1 <sup>11</sup> Bohr radius Ess modulation Pauli exclusion principle for electrons R <sub>plan</sub> =R <sub>carv</sub> for M <sub>plan</sub> =3.51x10 <sup>23</sup> kg*/0.175M <sub>sun</sub>
1.351x10 <sup>11</sup> 83.290 days	2πR <sub>l</sub> =2.158884301x1 0 <sup>15</sup>	4π <sup>2</sup> R <sub>l</sub> R <sub>e</sub> * 37.680	2πR <sub>l</sub> =1.74533x10 <sup>-14</sup>	272,037.0	2.9306x10 <sup>7</sup> K* 4.14x10 <sup>-15</sup> J*/25.754 keV*	7.6939x 10 <sup>-12</sup> m* 900.123 m* 3.1160x 10 <sup>15</sup> kg*	R <sub>plan</sub> =R <sub>carv</sub> for M <sub>plan</sub> =3.65x10 <sup>23</sup> kg*/0.182M <sub>sun</sub>
2.559x10 <sup>11</sup> 15.771 days	λ <sup>*</sup> =4.087933536x10 <sup>15</sup> Monopolar mean classical bound	2πr <sup>*</sup> λ <sup>*</sup> MQB= 1.351	2πr <sup>*</sup> =3.30485x10 <sup>-15</sup> Monopolar mean quantum bound	625,160.7	1.0210x10 <sup>7</sup> K* 1.44x10 <sup>-14</sup> J*/89.723 keV*	2.2084x 10 <sup>-12</sup> m* 1,680.1 0 m* 8.9440x 10 <sup>14</sup> kg*	R <sub>plan</sub> =R <sub>carv</sub> for M <sub>plan</sub> =6.80x10 <sup>23</sup> kg*/0.340M <sub>sun</sub>
2.253x10 <sup>11</sup> 1.2x10 <sup>6</sup> s* 13.888 days	R <sub>l</sub> <sup>*</sup> =3.6x10 <sup>15</sup> as 360xR <sub>e</sub> x10 <sup>12</sup> =1/R <sub>l</sub> <sup>*</sup>	1	R <sub>e</sub> <sup>*</sup> =R <sub>e</sub> =10 <sup>10</sup> λ <sub>eff</sub> /360	666,181.2	1.1231x10 <sup>7</sup> K* 1.59x10 <sup>-14</sup> J*/98.696 keV*	2.0076x 10 <sup>-12</sup> m* 1,762.1 0 m* 8.1309x 10 <sup>14</sup> kg*	unity modulation bounded by Dirac's monopole R <sub>plan</sub> =R <sub>carv</sub> for M <sub>plan</sub> =7.14x10 <sup>23</sup> kg*/0.357M <sub>sun</sub>
2.151x10 <sup>11</sup> 13.256 days	R <sub>l</sub> <sup>*</sup> =√E(λ <sub>eff</sub> /2π)=3.43 597108x10 <sup>14</sup>	R <sub>l</sub> R <sub>e</sub> 0.9544	R <sub>e</sub> <sup>*</sup> =2.7777x10 <sup>-15</sup>	681,897.2	1.1630x10 <sup>7</sup> K* 1.64x10 <sup>-14</sup> J*/102.20 keV*	1.9387x 10 <sup>-12</sup> m* 1,793.1 37 m* 7.8519x 10 <sup>14</sup> kg*	R <sub>plan</sub> =R <sub>carv</sub> for M <sub>plan</sub> =7.26x10 <sup>23</sup> kg*/0.363M <sub>sun</sub>



1.329x10 <sup>-13</sup> 8.193 days	2.1235470x10 <sup>-14</sup>	0.3645 6	$XR_n=1.716761x10^{-15}$ $=\sqrt[3]{A}$ for $A=5=(2X+1)^2$ Atomic radius for nucleus $XR_n/MQB=1.2707$ $\sqrt[3]{A}$ with A the atomic number	867,386.8	1.6685x10 <sup>3</sup> K* 2.36x10 <sup>-14</sup> J*/146.62 keV*	1.3514x 10 <sup>-12</sup> m* 2,147.7 64 m* 5.4731x 10 <sup>14</sup> kg*	$R_{\text{degen}}=R_{\text{curv}}$ for $M_{\text{degen}}=8.70x10^{23}$ kg*/0.435M <sub>sun</sub>
1.075x10 <sup>-13</sup> 6.628 days	1.7179379x10 <sup>-14</sup>	0.2386 $\sim \sqrt[3]{X}$	$\frac{1}{2}R_n=1.38885x10^{-15}$ $\frac{1}{2}(X+\frac{1}{2}X)R_n=\frac{3}{4}XR_n=$ $1.2875x10^{-15}$ $\sim XR_n/MQB$	964,362.2	1.9560x10 <sup>3</sup> K* 2.76x10 <sup>-14</sup> J*/171.89 keV*	1.1527x 10 <sup>-12</sup> m* 2,325.4 55 m* 4.6686x 10 <sup>14</sup> kg*	$R_{\text{degen}}=R_{\text{curv}}$ for $M_{\text{degen}}=9.42x10^{23}$ kg*/0.471M <sub>sun</sub>
6.646x10 <sup>-13</sup> 4.096 days	1.06177383x10 <sup>-13</sup>	0.0911	$\frac{1}{10}XR_n=8.583806x10^{-16}$  Proton charge radius for neutron degeneracy	1.22667x10 <sup>6</sup>	2.8061x10 <sup>3</sup> K* 3.96x10 <sup>-14</sup> J*/246.59 keV*	8.0352x 10 <sup>-13</sup> m* 2,785.3 20 m* 3.2543x 10 <sup>14</sup> kg*	$R_{\text{degen}}=R_{\text{curv}}$ for $M_{\text{degen}}=1.13x10^{24}$ kg*/0.564M <sub>sun</sub>
4.072x10 <sup>-13</sup> 2.510 days	$R^*=\lambda_c^*/2\pi=6.506148$ 293x10 <sup>13</sup> Monopolar lower classical bound	$r^*R^*$ 0.0342	$r^*=R_nR^*/R_c=5.2598x$ 10 <sup>-16</sup> Monopolar lower quantum bound	1.56705x10 <sup>6</sup>	4.0517x10 <sup>3</sup> K* 5.72x10 <sup>-14</sup> J*/356.06 keV*	5.5650x 10 <sup>-13</sup> m* 3,346.8 96 m* 2.2538x 10 <sup>14</sup> kg*	$R_{\text{degen}}=R_{\text{curv}}$ for $M_{\text{degen}}=1.36x10^{24}$ kg*/0.678M <sub>sun</sub>
3.423x10 <sup>-13</sup> 2.110 days	$R_c/2\pi=5.468517817x$ 10 <sup>13</sup>	$R_cR_n/4$ $\pi^2$ 0.0242	$R_n/2\pi=4.42097x10^{-16}$	1.70926x10 <sup>6</sup>	4.6156x10 <sup>3</sup> K* 6.52x10 <sup>-14</sup> J*/405.61 keV*	4.8851x 10 <sup>-13</sup> K* 3,572.2 15 m* 1.9785x 10 <sup>14</sup> kg*	$R_{\text{degen}}=R_{\text{curv}}$ for $M_{\text{degen}}=1.45x10^{24}$ kg*/0.723M <sub>sun</sub>
2.455x10 <sup>-13</sup> 1.513 days	3.92162x10 <sup>-13</sup>	0.0124	3.17040x10 <sup>-16</sup>	2.0184x10 <sup>6</sup>	5.9229x10 <sup>3</sup> K* 8.36x10 <sup>-14</sup> J*/520.49 keV*	3.80686 x10 <sup>-13</sup> m* 4,045.5 03 m* 1.5418x 10 <sup>14</sup> kg*	$R_{\text{degen}}=R_n/\alpha_c=\text{Compton}$ radius Electron degeneracy surface for neutron stars $R_{\text{degen}}=R_{\text{curv}}$ for $M_{\text{degen}}=1.64x10^{24}$ kg*/0.819M <sub>sun</sub>
1.443x10 <sup>-13</sup> 76,863.6 s* 21.35 hours	2.30591x10 <sup>-13</sup>	4.30x1 0 <sup>-3</sup>	1.86419x10 <sup>-16</sup>	2.6322x10 <sup>6</sup>	8.8207x10 <sup>3</sup> K* 1.25x10 <sup>-13</sup> J*/775.15 keV*	2.5562x 10 <sup>-13</sup> m* 4,938.2 71 m* 1.0353x 10 <sup>14</sup> kg*	$R_{\text{degen}}=R_{\text{curv}}$ for $M_{\text{degen}}=2.00x10^{24}$ kg*/1.000M <sub>sun</sub>
4.895x10 <sup>-13</sup> 26,069.4 s* 7.24 hours	7.82083x10 <sup>-12</sup>	4.95x1 0 <sup>-4</sup>	6.32267x10 <sup>-17</sup>	4.5198x10 <sup>6</sup>	1.9847x10 <sup>10</sup> K* 2.80x10 <sup>-13</sup> J*/1.744 MeV*	1.1361x 10 <sup>-13</sup> m* 7,407.4 07 m* 4.6011x 10 <sup>13</sup> kg*	Nuclear density $\rho_{\text{nuc}}=3m_pY^3/4\pi(R_n)^3$ $(1.105-1.907)x10^{16}$ [kg/m <sup>3</sup> ]* $M=\Sigma m_{\text{nu}}=\Sigma hf_{\text{nu}}/c^2$ mass quantization for space quanta count $M/\Sigma m_{\text{nu}}=h/m_{\text{nu}}c^2=hf_{\text{nu}}/h$ $=f_{\text{nu}} _{\text{red}}=3x10^{10}$ as $M_{\text{charstar}}=1.50 M_{\text{sun}}$
2.117x10 <sup>-14</sup> 11,274.58 s* 3.132 hours	3.38237x10 <sup>-12</sup>	9.25x1 0 <sup>-5</sup>	2.73445x10 <sup>-17</sup>	6.8728x10 <sup>6</sup>	3.7215x10 <sup>10</sup> K* 5.25x10 <sup>-13</sup> J*/3.270 MeV*	6.05875 x10 <sup>-14</sup> m* 10,143. 34 m* 2.4538x 10 <sup>13</sup> kg*	$R_{\text{degen}}=R_n/2\pi\alpha_c =$ Compton radius Ess modulation Electron degeneracy core for neutron stars $R_{\text{degen}}=R_{\text{curv}}$ for $M_{\text{degen}}=4.11x10^{24}$ kg*/2.054M <sub>sun</sub>

1.938x10 <sup>-14</sup> 10,320.0 s* 2.87 hours	3.0959915x10 <sup>-11</sup>	7.75x1 0 <sup>5</sup>	2.502924x10 <sup>-17</sup>	7.1836x10 <sup>7</sup>	3.9768x10 <sup>10</sup> K* 5.61x10 <sup>-13</sup> J*/3.495 MeV*	5.6698x 10 <sup>-14</sup> m* 10,485. 55 m* 2.2963x 10 <sup>13</sup> kg*	Modulation MQB/0.9544=1.41555 for M <sub>Chandra</sub> lower Tolman- Oppenheimer-Volkoff (TOV) limit for neutron stars R <sub>planet</sub> =R <sub>curv</sub> for M <sub>planet</sub> =4.25x10 <sup>31</sup> kg*/2.123 M <sub>sun</sub>
1.013x10 <sup>-14</sup> 5395.05 s* 1.50 hours	1.618509x10 <sup>-12</sup>	2.12x1 0 <sup>5</sup>	1.3084678x10 <sup>-17</sup>	9.9354x10 <sup>7</sup>	6.4684x10 <sup>10</sup> K* 9.13x10 <sup>-13</sup> J*/5.684 MeV*	3.4858x 10 <sup>-14</sup> m* 13,372. 84 m* 1.4117x 10 <sup>13</sup> kg*	Neutron decay mass loss: 8.844/4.900=1.805 Increases M <sub>Chandra</sub> to 1.805M <sub>Chandra</sub> =2.708 M <sub>sun</sub> as upper TOV-limit for neutron stars R <sub>planet</sub> =R <sub>curv</sub> for M <sub>planet</sub> =5.42x10 <sup>31</sup> kg*/2.708 M <sub>sun</sub>
4.028x10 <sup>-15</sup> 2144.96 s* 32.749 min	6.43488x10 <sup>-11</sup>	3.35x1 0 <sup>6</sup>	5.20221x10 <sup>-18</sup>	1.5757x10 <sup>7</sup>	1.2919x10 <sup>11</sup> K* 1.82x10 <sup>-12</sup> J*/11.35 MeV*	1.7453x 10 <sup>-14</sup> m* 18,899. 00 m* 7.0686x 10 <sup>12</sup> kg*	R <sub>limiting</sub> =2πR <sub>e</sub> R <sub>planet</sub> =R <sub>curv</sub> for M <sub>planet</sub> =7.65x10 <sup>31</sup> kg*/3.827M <sub>sun</sub>
2.160x10 <sup>-15</sup> 1150.36 s* 19.173 min	R <sub>e</sub> =√F(λ <sub>cosy</sub> /2π)=3.45 107750x10 <sup>-11</sup>	9.63x1 0 <sup>7</sup>	R <sub>e</sub> =2.789990x10 <sup>-18</sup>	2.15163x10 <sup>7</sup>	2.0614x10 <sup>11</sup> K* 2.91x10 <sup>-12</sup> J*/18.12 MeV*	1.0938x 10 <sup>-14</sup> m* 23,872. 87 m* 4.4299x 10 <sup>12</sup> kg*	R <sub>planet</sub> =R <sub>curv</sub> for M <sub>planet</sub> =9.67x10 <sup>31</sup> kg*/4.834M <sub>sun</sub>
2.123x10 <sup>-15</sup> 1130.52 s* 18.8420 min	R <sub>e</sub> =√F(λ <sub>cosy</sub> /2π)=3.39 155801x10 <sup>-11</sup>	9.30x1 0 <sup>7</sup>	R <sub>e</sub> =2.741872x10 <sup>-18</sup>	2.17042x10 <sup>7</sup>	2.0885x10 <sup>11</sup> K* 2.95x10 <sup>-12</sup> J*/18.35 MeV*	1.0796x 10 <sup>-14</sup> m* 24,029. 28 m* 4.3724x 10 <sup>12</sup> kg*	R <sub>planet</sub> =R <sub>curv</sub> for M <sub>planet</sub> =9.73x10 <sup>31</sup> kg*/4.866M <sub>sun</sub>
2.084x10 <sup>-15</sup> 1109.96 s* 18.499 min	R <sub>e</sub> =√F(λ <sub>cosy</sub> /2π)=3.3 2987275x10 <sup>-11</sup>	8.96x1 0 <sup>7</sup>	R <sub>e</sub> =2.69200x10 <sup>-18</sup>	2.19044x10 <sup>7</sup>	2.1175x10 <sup>11</sup> K* 2.99x10 <sup>-12</sup> J*/18.61 MeV*	1.0648x 10 <sup>-14</sup> m* 24,195. 54 m* 4.3125x 10 <sup>12</sup> kg*	Primordial neutron decay: λ <sub>e</sub> -2πλ <sub>cosy</sub> (1109.96-229.82) s* = 880.14 s*/879.28 s from Higgs Boson with RMP template Neutron decay mass loss: 8.844/4.900=1.805 Increases M <sub>Chandra</sub> to 1.805M <sub>Chandra</sub> =2.708 M <sub>sun</sub> as upper TOV-limit for neutron stars R <sub>planet</sub> =R <sub>curv</sub> for M <sub>planet</sub> =9.80x10 <sup>31</sup> kg*/4.900M <sub>sun</sub>
8.754x10 <sup>-16</sup> 466.186 s* 7.770 min	1.39856x10 <sup>-11</sup>	1.19x1 0 <sup>7</sup>	8.5232x10 <sup>-19</sup>	3.89284x10 <sup>7</sup>	5.0167x10 <sup>11</sup> K* 7.08x10 <sup>-12</sup> J*/44.09 MeV*	5.55556 x10 <sup>-15</sup> m* 33,497. 33 m* 2.2500x 10 <sup>12</sup> kg*	R <sub>limiting</sub> =2R <sub>e</sub> R <sub>planet</sub> =R <sub>curv</sub> for M <sub>planet</sub> =1.3566x10 <sup>31</sup> kg*/6.78M <sub>sun</sub>

4.315x10 <sup>10</sup> 229.821 s* 3.8304 min	R <sub>neutrondecay</sub> =6.894632 3x10 <sup>10</sup>	3.84x1 0 <sup>8</sup>	2πλ <sub>DM</sub> =4π <sup>2</sup> R <sub>DM</sub> =5.5 7389763x10 <sup>-21</sup>	4.81381x10 <sup>7</sup>	6.89874x10 <sup>11</sup> K* 9.74x10 <sup>-12</sup> J*/60.62 MeV*	3.2684x 10 <sup>-15</sup> m* 43,672. 54 m* 1.3237x 10 <sup>12</sup> kg*	Beginning of neutron decay from Higgs Boson with RMP template R <sub>plan</sub> =R <sub>curv</sub> for M <sub>plan</sub> =1.77x10 <sup>11</sup> kg*/8.844M <sub>sun</sub>
3.474x10 <sup>10</sup> 185.006 s* 3.083 min	5.550187x10 <sup>10</sup>	2.49x1 0 <sup>8</sup>	4.486994x10 <sup>-10</sup>	5.36526x10 <sup>7</sup>	8.1172x10 <sup>-11</sup> K* 1.15x10 <sup>-11</sup> J*/71.33 MeV* to 3.1636x10 <sup>-12</sup> K*	2.7778x 10 <sup>-15</sup> m* 47,372. 40 m* 1.1250x 10 <sup>12</sup> kg*	R <sub>limiting</sub> =R <sub>e</sub> limited by ρ <sub>nuclear</sub> =m <sub>e</sub> /R <sub>e</sub> <sup>3</sup> Nuclear density ρ <sub>nuc</sub> =3m <sub>e</sub> Y <sup>3</sup> /4π{R <sub>e</sub> } <sup>3</sup> (1.105-1.907)x10 <sup>16</sup> [kg/m <sup>3</sup> ]* R <sub>plan</sub> =R <sub>curv</sub> for M <sub>plan</sub> =1.92x10 <sup>11</sup> kg*/9.593M <sub>sun</sub>
1.829x10 <sup>10</sup> 97.398 s* 1.623 min	2.921968x10 <sup>10</sup>	6.90x1 0 <sup>0</sup>	2.362236x10 <sup>-10</sup>	7.39446x10 <sup>7</sup>	1.3134x10 <sup>-12</sup> K* 1.85x10 <sup>-11</sup> J*/115.4 MeV* to 1.3401x10 <sup>2</sup> K*	1.7168x 10 <sup>-15</sup> m* 60,257. 94 m* 6.9529x 10 <sup>11</sup> kg*	R <sub>limiting</sub> =XR <sub>e</sub> limited by ρ <sub>nuclear</sub> =Y <sup>3</sup> m <sub>e</sub> /R <sub>e</sub> <sup>3</sup> Nuclear density ρ <sub>nuc</sub> =3m <sub>e</sub> Y <sup>3</sup> /4π{XR <sub>e</sub> } <sup>3</sup> (4.683-8.077)x10 <sup>16</sup> [kg/m <sup>3</sup> ]* R <sub>plan</sub> =R <sub>curv</sub> for M <sub>plan</sub> =2.44x10 <sup>11</sup> kg*/12.202M <sub>sun</sub>
1.379x10 <sup>10</sup> 73.422 s* 1.224 min	2.202648x10 <sup>10</sup>	3.92x1 0 <sup>0</sup>	1.780709x10 <sup>-10</sup>	8.51671x10 <sup>7</sup>	1.6234x10 <sup>-12</sup> K* 2.29x10 <sup>-11</sup> J*/142.7 MeV* to 2.5309x10 <sup>13</sup> K*	1.3889x 10 <sup>-15</sup> m* 66,994. 07 m* 5.6250x 10 <sup>11</sup> kg*	R <sub>limiting</sub> =½R <sub>e</sub> =protonic diameter limited by ρ <sub>nuclear</sub> =8m <sub>p</sub> /R <sub>e</sub> <sup>3</sup> Nuclear density ρ <sub>nuc</sub> =3m <sub>p</sub> Y <sup>3</sup> /4π{½R <sub>e</sub> } <sup>3</sup> (8.844-15.253)x10 <sup>16</sup> [kg/m <sup>3</sup> ]* R <sub>plan</sub> =R <sub>curv</sub> for M <sub>plan</sub> =2.71x10 <sup>11</sup> kg*/13.566M <sub>sun</sub>
1.172x10 <sup>10</sup> 62.425 s*	1.87274220x10 <sup>10</sup>	2.84x1 0 <sup>0</sup>	R <sub>VL</sub> =2πL <sub>VL</sub> =1.514x10 <sup>-10</sup> L <sub>VL</sub> =r <sub>VL</sub> =2.410x10 <sup>-20</sup>	9.2365x10 <sup>7</sup>	1.8335x10 <sup>-12</sup> K* 2.59x10 <sup>-11</sup> J*/161.1 MeV*	1.2298x 10 <sup>-15</sup> m* 71,197. 38 m* 4.9806x 10 <sup>11</sup> kg*	Supermembrane modulation for the XL- boson string in spacetime from spacetime for quark- lepton differentiation
7.258x10 <sup>17</sup> 38.650 s*	1.159515x10 <sup>10</sup>	1.09x1 0 <sup>0</sup>	9.37398x10 <sup>-20</sup>	1.17383x10 <sup>8</sup>	2.6268x10 <sup>-12</sup> K* 3.71x10 <sup>-11</sup> J*/230.8 MeV* to 1.0721x10 <sup>16</sup> K*	8.5838x 10 <sup>-16</sup> m* 85,218. 27 m* 3.4764x 10 <sup>11</sup> kg*	R <sub>limiting</sub> =½XR <sub>e</sub> limited by ρ <sub>nuclear</sub> =8Y <sup>3</sup> m <sub>e</sub> /R <sub>e</sub> <sup>3</sup> Nuclear density ρ <sub>nuc</sub> =3m <sub>e</sub> Y <sup>3</sup> /4π{½XR <sub>e</sub> } <sup>3</sup> (3.746-6.461)x10 <sup>17</sup> [kg/m <sup>3</sup> ]* R <sub>plan</sub> =R <sub>curv</sub> for M <sub>plan</sub> =3.45x10 <sup>11</sup> kg*/17.257M <sub>sun</sub>
6.868x10 <sup>17</sup> 36.577 s*	1.09731481x10 <sup>10</sup> 36.577 s*	9.73x1 0 <sup>10</sup>	λ <sub>DM</sub> =2πR <sub>DM</sub> =8.871 13360x10 <sup>-20</sup>	1.2066x10 <sup>8</sup>	2.7377x10 <sup>-12</sup> K* 3.86x10 <sup>-11</sup> J*/240.6 MeV*	8.2360x 10 <sup>-16</sup> m* 86,999. 42 m* 3.3356x 10 <sup>11</sup> kg*	Supermembrane modulation for the dark matter agent RMP in wavelength λ <sub>DM</sub> =2πR <sub>DM</sub> dark matter particle 1 <sup>st</sup> wave matter neutron twin is born from ylem neutron in radial manifestation R <sub>plan</sub> =R <sub>curv</sub> for M <sub>plan</sub> =3.52x10 <sup>11</sup> kg*/17.617M <sub>sun</sub>

5.664x10 <sup>-17</sup> 30.164 s*	9.04906x10 <sup>9</sup>	6.62x1 0 <sup>-10</sup>	7.31562x10 <sup>-20</sup>	1.32875x10 <sup>8</sup>	3.163603x1 0 <sup>12</sup> K* 4.47x10 <sup>-11</sup> J*/278.0 MeV*	7.1272x 10 <sup>-16</sup> m* 93,522. 16 m* 2.8865x 10 <sup>11</sup> kg*	For electron degeneracy $\rho_{\text{neutron}}=m_p/R_w^3$ for a temperature limit of $T_{\text{Hawking}}=m_p c^2/2k_B=3.163$ $603 \times 10^{12}$ K* = Neutron star-black hole limit $\rho_{\text{neutron}}=\rho_{\text{BH}}$ $R_{\text{planet}}=R_{\text{curv}}$ for $M_{\text{planet}}=3.7876 \times 10^{31}$ kg*/18.938M <sub>sun</sub>
3.900x10 <sup>-17</sup> 20.768 s*	6.23051682x10 <sup>9</sup>	3.14x1 0 <sup>-10</sup>	$R_{\text{IC}}=2\pi L_{\text{IC}}=5.037 \times 10^{-20}$ $L_{\text{IC}}=r_{\text{IC}}=8.017 \times 10^{-21}$	1.6013x10 <sup>8</sup>	4.1854x10 <sup>1</sup> 2 K* 5.91x10 <sup>-11</sup> J*/367.8 MeV*	5.3872x 10 <sup>-16</sup> m* 107,570 .18 m* 2.1818x 10 <sup>11</sup> kg*	Supermembrane modulation for the Cosmic boson string in spacetime from spacetime $R_{\text{planet}}=R_{\text{curv}}$ for $M_{\text{planet}}=4.36 \times 10^{32}$ kg*/21.783M <sub>sun</sub>
2.996x10 <sup>-17</sup> 15.957 s*	4.78696x10 <sup>9</sup>	1.85x1 0 <sup>-10</sup>	3.86997x10 <sup>-20</sup>	1.82690x10 <sup>8</sup>	5.1002x10 <sup>1</sup> 2 K* 7.20x10 <sup>-11</sup> J*/448.2 MeV*	4.42097 x10 <sup>-16</sup> m* 118,744 .56 m* 1.7905x 10 <sup>11</sup> kg*	$R_{\text{Hawking}}=R_w/2\pi$ Ess modulation Neutron degeneracy $R_{\text{planet}}=R_{\text{curv}}$ for $M_{\text{planet}}=4.81 \times 10^{32}$ kg*/24.05M <sub>sun</sub>
1.093x10 <sup>-17</sup> 5.821 s*	1.74643077x10 <sup>9</sup>	2.47x1 0 <sup>-11</sup>	$R_{\text{RMP}}=1.411884763 \times 10^{-20}$	3.0246x10 <sup>8</sup>	1.0865x10 <sup>1</sup> 3 K* 1.53x10 <sup>-10</sup> J*/954.8 MeV*	2.0753x 10 <sup>-16</sup> m* 173,315 .85 m* 8.4050x 10 <sup>10</sup> kg*	Supermembrane modulation for the dark matter agent RMP in radius $R_{\text{RMP}} =$ $\sqrt[3]{(e^* \cdot dt_{\text{rel}}/d_{\text{sp}})_{\text{transverse}}/2}$ $\pi^2$ $= \sqrt[3]{\{(e^*/2\pi^2)/(9 \times 10^{60})\}}$ Y <sup>2</sup> M <sup>2</sup> C <sup>2</sup> quark geometric template for lefthanded ylemic neutron boson as precursor for fermionic Higgs Boson template Higgs boson string maximum in spacetime from spacetime $R_{\text{planet}}=R_{\text{curv}}$ for $M_{\text{planet}}=7.02 \times 10^{32}$ kg*/35.096M <sub>sun</sub>
8.264x10 <sup>-18</sup> 4.401 s*	1.320239x10 <sup>9</sup>	1.41x1 0 <sup>-11</sup>	1.0673343x10 <sup>-20</sup>	3.4787x10 <sup>8</sup>	1.340124x1 0 <sup>11</sup> K* 1.53x10 <sup>-10</sup> J*/954.8 MeV*	1.6825x 10 <sup>-16</sup> m* 192,484 .62 m* 6.8141x 10 <sup>10</sup> kg*	For neutron degeneracy in the diameter of a protonic nucleus $\rho_{\text{neutron}}=Y^3 m_p R_w$ $R_{\text{planet}}=R_{\text{curv}}$ for $M_{\text{planet}}=7.7956 \times 10^{31}$ kg*/38.978M <sub>sun</sub>
5.523x10 <sup>-18</sup> 2.941 s*	8.82440084x10 <sup>8</sup>	6.30x1 0 <sup>-12</sup>	$R_{\text{Higgs}}=2\pi L_{\text{Higgs}}=7.134$ $\times 10^{-21}$ $L_{\text{Higgs}}=r_{\text{Higgs}}=1.135 \times 10^{-21}$	4.2550x10 <sup>8</sup>	1.8129x10 <sup>1</sup> 3 K* 2.56x10 <sup>-10</sup> J*/1.59 GeV*	1.2437x 10 <sup>-16</sup> m* 223,877 .44 m* 5.0372x 10 <sup>10</sup> kg*	Supermembrane modulation for the Higgs boson string minimum in spacetime from spacetime $R_{\text{planet}}=R_{\text{curv}}$ for $M_{\text{planet}}=9.07 \times 10^{32}$ kg*/45.335M <sub>sun</sub>

$3.540 \times 10^{13}$ 1.885 s*	$5.65566 \times 10^9$	$2.59 \times 10^{12}$	$4.572262 \times 10^{-21}$	$5.3150 \times 10^9$	$2.530882 \times 10^{13}$ K* $3.57 \times 10^{-10}$ J*/2.22 GeV*	$8.9090 \times 10^{-17}$ m* 264,520 .60 m* $3.6081 \times 10^{10}$ kg*	For neutron degeneracy in the radial size of a protonic nucleus $\rho_{\text{dector}} = 8m_p R_p^{-3}$ $R_{\text{dector}} = R_{\text{cluv}}$ for $M_{\text{dector}} = 1.07131 \times 10^{12}$ kg*/53.565M <sub>sun</sub>
$9.066 \times 10^{13}$ 0.4828 s*	$1.44846837 \times 10^8$	$1.70 \times 10^{13}$	$R_{\text{Higgs}} = 2\pi L_{\text{Higgs}} = 1.171 \times 10^{-21}$ $L_{\text{Higgs}} = \Gamma_{\text{Higgs}} = 1.864 \times 10^{-22}$	$1.0502 \times 10^9$	$7.0300 \times 10^3$ K* $9.92 \times 10^{-10}$ J*/6.18 GeV*	$3.2074 \times 10^{-17}$ m* 440,860 .38 m* $1.2990 \times 10^{10}$ kg*	Supermembrane modulation for the Higgs boson string maximum in spacetime from spacetime $R_{\text{dector}} = R_{\text{cluv}}$ for $M_{\text{dector}} = 1.79 \times 10^{12}$ kg*/89.274M <sub>sun</sub>
$5.165 \times 10^{13}$ 0.27505 s*	$8.251498 \times 10^7$	$5.50 \times 10^{14}$	$6.670843 \times 10^{-22}$	$1.3915 \times 10^9$	$1.072099 \times 10^{14}$ K* $1.51 \times 10^{-9}$ J*/9.42 GeV*	$2.1031 \times 10^{-17}$ m* 544,428 .68 m* $8.5177 \times 10^9$ kg*	For neutron degeneracy in the charge radius of a proton $\rho_{\text{dector}} = 8Y^3 m_p R_p^{-3} =$ Quark star limit $R_{\text{dector}} = R_{\text{cluv}}$ for $M_{\text{dector}} = 2.20494 \times 10^{12}$ kg*/110.25M <sub>sun</sub>
$4.917 \times 10^{13}$ 0.2618 s*	$7.85497 \times 10^7$	$4.99 \times 10^{14}$	$6.350273 \times 10^{-22}$	$1.4262 \times 10^9$	$1.11243 \times 10^{14}$ K* $1.57 \times 10^{-9}$ J*/9.78 GeV*	$2.0269 \times 10^{-17}$ m* 554,574 .32 m* $8.2089 \times 10^9$ kg*	$R_{\text{Compton}} = \alpha R_p =$ Inverse Compton radius $R_{\text{dector}} = R_{\text{cluv}}$ for $M_{\text{dector}} = 2.25 \times 10^{12}$ kg*/112.30M <sub>sun</sub>
$4.864 \times 10^{13}$ 0.2591 s*	$7.77175644 \times 10^7$	$7.77 \times 10^{15}$	$2\pi \lambda_{\text{ph}} = 6.283 \times 10^{-22}$	$1.4338 \times 10^9$	$1.1214 \times 10^{14}$ K* $1.58 \times 10^{-9}$ J*/9.85 GeV*	$2.0107 \times 10^{-17}$ m* 556,805 .71 m* $8.1435 \times 10^9$ kg*	Supermembrane modulation for the radius of the QBBS boson string in spacetime from spacetime $R_{\text{dector}} = R_{\text{cluv}}$ for $M_{\text{dector}} = 2.26 \times 10^{12}$ kg*/112.75M <sub>sun</sub>
$7.7422 \times 10^{13}$ 0.04123 s*	$1.23694994 \times 10^7$	$1.24 \times 10^{15}$	$\lambda_{\text{ph}} = 10^{-22}$	$3.3594 \times 10^9$	$4.4501 \times 10^{14}$ K* $6.28 \times 10^{-9}$ J*/39.11 GeV*	$5.0668 \times 10^{-18}$ m* $1.1092 \times 10^9$ m* $2.0520 \times 10^9$ kg*	Supermembrane modulation for the wavelength of the QBBS boson string in spacetime as timespace $R_{\text{dector}} = R_{\text{cluv}}$ for $M_{\text{dector}} = 4.49 \times 10^{12}$ kg*/224.61M <sub>sun</sub>
$1.340 \times 10^{-13}$ 1/140 = 0.00714 s*	$R_{\text{EM}} = 2.141143 \times 10^7$ Dark matter universe is illuminated as the EMI light path intersects the dark matter haloed ylemic universe	$3.71 \times 10^{17}$	$1.730986 \times 10^{-13}$ Ylemic radius shrinks as the radial universe expands with the separation of the short range nuclear weakon interaction from the long-range electromagnetic interaction	$8.6382 \times 10^9$	$1.65825 \times 10^{15}$ K* $2.34 \times 10^{-9}$ J*/145.7 GeV*	$1.3597 \times 10^{-18}$ m* 2.14115 $\times 10^9$ m* $5.5069 \times 10^9$ kg*	Electroweak Unification $T_{\text{EM}} = E/k_b = 2 \times 10^{15}$ K* (146-251) GeV* for (W <sup>+</sup> +W <sup>+</sup> +Z <sup>0</sup> ) $R_{\text{dector}} = R(n)$ as size of the universe Dark matter halo defined as a quark-lepton geometric kernel-ring structure crystallizing the ylem neutrons from Higgs Boson/RMP template $R_{\text{dector}} = R_{\text{cluv}}$ for $M_{\text{dector}} = 8.67 \times 10^{12}$ kg*/433.58M <sub>sun</sub>

1.233x10 <sup>-21</sup> 0.00656 s*	1.96922430x10 <sup>6</sup>	3.13x1 0 <sup>-17</sup>	$\lambda_{\text{QED}}/2\pi=1.592x10^{-22}$	9.0073x10 <sup>0</sup>	1.7657x10 <sup>15</sup> K* 2.49x10 <sup>-8</sup> J*/155.2 GeV*	1.2770x 10 <sup>-18</sup> m* 2.2094x 10 <sup>0</sup> m* 5.1718x 10 <sup>0</sup> kg*	Supermembrane modulation for modulated wavelength of the QBBS boson string in spacetime from timespace $R_{\text{QED}}=R_{\text{CMB}}$ for $M_{\text{Planck}}=8.95x10^{22}$ kg*/447.40M <sub>sun</sub>
6.613x10 <sup>-24</sup> 0.00352 s*	1.0564789x10 <sup>6</sup>	9.02x1 0 <sup>-18</sup>	8.541000x10 <sup>-24</sup>	1.2297x10 <sup>1</sup> 0	2.8167x10 <sup>15</sup> K* 3.97x10 <sup>-8</sup> J*/247.5 GeV*	8.0050x 10 <sup>-10</sup> m* 2.7906x 10 <sup>0</sup> m* 3.2420x 10 <sup>0</sup> kg*	Supermembrane modulation for the Higgs boson string maximum in spacetime from timespace $R_{\text{QED}}=R_{\text{CMB}}$ for $M_{\text{Planck}}=1.13x10^{21}$ kg*/565.10M <sub>sun</sub>
1.085x10 <sup>-23</sup> 5.781x10 <sup>-1</sup>	173,420.38	2.43x1 0 <sup>-19</sup>	1.40200x10 <sup>-24</sup>	3.0353x10 <sup>1</sup> 0	1.0922x10 <sup>15</sup> K* 1.54x10 <sup>-7</sup> J*/959.8 GeV*	2.0644x 10 <sup>-10</sup> m* 5.4951x 10 <sup>0</sup> m* 8.3608x 10 <sup>0</sup> kg*	Supermembrane modulation for the Higgs boson string minimum in spacetime from timespace $R_{\text{QED}}=R_{\text{CMB}}$ for $M_{\text{Planck}}=2.23x10^{21}$ kg*/1112.75M <sub>sun</sub>
6.958x10 <sup>-23</sup> 3.706x10 <sup>-1</sup>	111,173.6	9.99x1 0 <sup>-20</sup>	8.98772x10 <sup>-25</sup>	3.791x10 <sup>11</sup>	1.52452x10 <sup>16</sup> K* 2.15x10 <sup>-7</sup> J*/1.338 TeV*	1.4790x 10 <sup>-10</sup> m* 6.4921x 10 <sup>0</sup> m* 5.9898x 10 <sup>0</sup> kg*	$R_{\text{Bohr}}=\alpha^2 R_s =$ Inverse 1 <sup>st</sup> Bohr radius for ylemic template for atomic structure as micro-Hawking black hole to manifest at $R_{\text{Bohr}}/\alpha^4=9.798883x10^{-7}$ m* $R_{\text{QED}}=R_{\text{CMB}}$ for $M_{\text{Planck}}=2.63x10^{21}$ kg*/1314.65M <sub>sun</sub>
1.537x10 <sup>-23</sup> 8.184x10 <sup>-1</sup>	24,553.46	4.87x1 0 <sup>-21</sup>	1.9850x10 <sup>-25</sup>	8.0666x10 <sup>1</sup> 0	4.7321x10 <sup>16</sup> K* 6.68x10 <sup>-7</sup> J*/4.158 TeV*	4.7648x 10 <sup>-10</sup> m* 1.1438x 10 <sup>0</sup> m* 1.9298x 10 <sup>0</sup> kg*	Supermembrane modulation for the Cosmic boson string in spacetime from timespace $R_{\text{QED}}=R_{\text{CMB}}$ for $M_{\text{Planck}}=4.63x10^{21}$ kg*/2316.20M <sub>sun</sub>
3.562x10 <sup>-27</sup> 1.897x10 <sup>-1</sup>	$R_{\text{H}}=0.569092$ universe is 1.1382 meters across encompassed by a ylem dark matter halo of radius 6.2584x10 <sup>3</sup> m* in the inflaton EMMI universe	2.62x1 0 <sup>-20</sup>	4.60077x10 <sup>-30</sup> Ylemic universe is manifested in the primordial Hawking micro black hole defining the dark matter ylemic halo	1.676x10 <sup>-22</sup> 3.515x10 <sup>-25</sup> J* 2.19x10 <sup>-6</sup> eV*	$T_{\text{pl}}=1.4167x10^{20}$ K* 0.002 J*/12,449.8 TeV*	1.59155 x10 <sup>-23</sup> m* 6.2584x 10 <sup>0</sup> m* 6445.78 kg*	Bosonic temperature unification $T(n)=\sqrt{\frac{H_0^3 M_{\text{pl}}}{1100\pi^2 \sigma}} \cdot \frac{1}{(n+1)^{1/2} n^2}$ $=\sqrt{\frac{18.2(n+1)^2/n^3}{n^2}}=T_{\text{pl}}=1.4167x10^{20}$ K* $R_{\text{QED}}=R_{\text{CMB}}$ for $M_{\text{Planck}}=2.53x10^{25}$ kg*/126,732.0M <sub>sun</sub>
1.394x10 <sup>-27</sup> 7.422x10 <sup>-10</sup>	0.22267	4.01x1 0 <sup>-31</sup>	1.80019x10 <sup>-30</sup>	2.6786x10 <sup>1</sup> 3 8.98x10 <sup>-25</sup> J* 5.59x10 <sup>-6</sup> eV*	2.8634x10 <sup>20</sup> K*	7.8744x 10 <sup>-24</sup> m* 8.8974x 10 <sup>0</sup> m* 3189.14 kg*	$R_{\text{Bohr}}=\alpha^2 R_s =$ False Higgs Vacuum limited by wormhole radius $r_{\text{pl}}=\lambda_{\text{QED}}/2\pi$ $R_{\text{QED}}=R_{\text{CMB}}$ for $M_{\text{Planck}}=3.60x10^{25}$ kg*/180,172.4M <sub>sun</sub>

$5.114 \times 10^{-33}$ $2.723 \times 10^{-10}$	0.0817	$5.40 \times 10^{32}$	$6.60496 \times 10^{-31}$	$4.4221 \times 10^3$ $2.4480 \times 10^{26} \text{ J}^*$ $1.52 \times 10^{-5} \text{ eV}^*$	$6.0739 \times 10^{20} \text{ K}^*$	-	Supermembrane modulation for the XL-boson string for quark-lepton differentiation in spacetime from timespace
$3.570 \times 10^{-33}$ $1.901 \times 10^{-11}$	$5.704 \times 10^{-3}$	$2.63 \times 10^{34}$	$4.61134 \times 10^{-32}$	$1.6736 \times 10^4$ $3.5063 \times 10^{23} \text{ J}^*$ $2.18 \times 10^{-4} \text{ eV}^*$	$4.4720 \times 10^{21} \text{ K}^*$	-	Supermembrane modulation for the minimum monopole scale in spacetime from timespace on a characteristic star globular cluster scale
$1.190 \times 10^{-33}$ $6.337 \times 10^{-11}$	$1.9012 \times 10^{-4}$	$2.92 \times 10^{37}$	$1.5370 \times 10^{-33}$	$9.1671 \times 10^4$ $1.0520 \times 10^{21} \text{ J}^*$ $6.55 \times 10^{-3} \text{ eV}^*$	$5.7328 \times 10^{22} \text{ K}^*$	-	Supermembrane modulation for the maximum monopole scale in spacetime from timespace on a characteristic star globular cluster scale
$n_{\nu} = t_{\nu} = f_{\nu}$ $\leftrightarrow f_{\nu} = t_{\nu}$	Supermembrane modulation inversion	$3.3 \times 10^{31} =$ $1/3 \times 10^{31}$					$n_{\nu} = t_{\nu} = f_{\nu} \leftrightarrow f_{\nu} = t_{\nu} = 1/n_{\nu}$
$3.333 \times 10^{-11}$ $t_{\nu}^2/t_{ALGO} =$ $t_{\nu}/H_{\nu} =$ $1.775 \times 10^{-11}$	$R_{ALGO} = 2\pi L_{ALGO} = 5.3255$ $8484 \times 10^{-5}$ $L_{ALGO} = f_{ALGO} = 8.47593 \times 10^6$ Universe the size of smallest life bio-organisms; cellular complex 0.2 picoseconds	$3.51 \times 10^{20}$	$6.587377 \times 10^{-24}$	$1.732 \times 10^{15}$ $3.755 \times 10^{21} \text{ J}^*$ $0.02338 \text{ eV}^*$	$1.4889886 \times 10^{23} \text{ K}^*$	-	$n = H_{\nu} t_{\nu}^2 / n_{\nu} = c t_{\nu}^2 / \lambda_{\nu} = t_{\nu}$ $\nu = 1/f_{\nu} = f_{\nu}$ mass eigen frequency Image of 1 <sup>st</sup> Logos mathimatia definition
$1.017 \times 10^{-11}$ $5.414 \times 10^{-14}$	$1.6241 \times 10^{-5}$	$3.26 \times 10^{19}$	$2.0089 \times 10^{-28}$	$3.1365 \times 10^5$ $1.2315 \times 10^{20} \text{ J}^*$ $0.0766 \text{ eV}^*$	$3.6282 \times 10^{23} \text{ K}^*$	-	Supermembrane modulation for the Planck length in spacetime from timespace on a characteristic galactic core scale
$8.687 \times 10^{-11}$ $4.626 \times 10^{-15}$	$1.3879 \times 10^{-6}$	$2.38 \times 10^{17}$	$1.7168 \times 10^{-33}$	$1.0729 \times 10^6$ $1.441 \times 10^{19} \text{ J}^*$ $897.02 \text{ eV}^*$	$2.2954 \times 10^{28} \text{ K}^*$	-	Supermembrane modulation for the Planck length bounce in spacetime from timespace on a characteristic galaxy scale
$5.581 \times 10^{-30}$ $t_{\nu}^2/t_{OPL} =$ $= 2.972 \times 10^{18}$	$R_{OPL} = 2\pi L_{OPL} = 8.916 \times 10^{-10}$ $L_{OPL} = r_{OPL} = 1.419 \times 10^{-30}$ Universe the size of an atom	$9.83 \times 10^{10}$	$1.1028646 \times 10^{10}$	$4.23 \times 10^{17}$ $2.243 \times 10^{16} \text{ J}^*$ $1.396 \text{ keV}^*$	$5.6883 \times 10^{20} \text{ K}^*$	-	Planck Oscillation in timespace manifests in atomic complexity
$4.768 \times 10^{-37}$ $t_{\nu}^2/t_{PL} =$ $= 2.539 \times 10^{19}$	$R_{PL} = 2\pi L_{PL} = 7.617 \times 10^{-11}$ $L_{PL} = r_{PL} = 1.212 \times 10^{-37}$ Universe the size of the Bohr atom scale $\lambda_{\text{Bohr}} = R_{\nu} / \alpha^2$	$7.18 \times 10^9$	$9.42184766 \times 10^{18}$	$1.45 \times 10^{18}$ $2.626 \times 10^{15} \text{ J}^*$ $16.34 \text{ keV}^*$	$3.5997 \times 10^{27} \text{ K}^*$	-	Planck length of timespace manifests as atomic scale in spacetime
$1.454 \times 10^{-37}$ $7.743 \times 10^{-20}$	$2.32299 \times 10^{-11}$	$6.67 \times 10^6$	$2.873422 \times 10^{18}$	$2.6225 \times 10^8$ $8.610 \times 10^{15} \text{ J}^*$ $53.59 \text{ keV}^*$	$8.7719 \times 10^{27} \text{ K}^*$	-	Beginning of Inversion Modulation for the Algo wavelength in spacetime from timespace

$4.073 \times 10^{-20}$ $h/E$ $=2.169 \times 10^{-20}$	$R_{MD}=2\pi L_{MD}=6.507 \times 10^{-12}$ $L_{MD}=r_{MD}=1.036 \times 10^{-12}$ Universe the size of the wave matter de Broglie quantum scale $\lambda_{dB}=h/mc$	$5.24 \times 10^6$	$8.0488332 \times 10^{17}$	$4.95 \times 10^{13}$ $3.074 \times 10^{-14}$ $J^*$ 191.33 keV*	$2.2781 \times 10^{20}$ $K^*$	-	Monopole [30ec] <sub>max</sub> in timespace manifests in quantum mechanics in spacetime
$1.357 \times 10^{-20}$ $t_{ps}^2/t_{MD}$ $=7.229 \times 10^{-22}$	$R_{MD}=2\pi L_{MD}=2.169 \times 10^{-12}$ $L_{MD}=r_{MD}=3.451 \times 10^{-14}$ Universe the size of the Compton quantum scale $R_{Compton}=\lambda_{dB}/\alpha=h/2\pi mc$	5819.4	$2.6829444 \times 10^{15}$	$2.71 \times 10^{13}$ $9.221 \times 10^{-13}$ $J^*$ 5.74 MeV*	$2.9213 \times 10^{20}$ $K^*$	-	Monopole [ec] <sub>max</sub> in timespace manifests in quantum mechanics in spacetime
$1.300 \times 10^{-20}$ $6.922 \times 10^{-21}$	$4\pi^2 r^* = 2.07650 \times 10^{-14}$ Monopolar upper quantum bound	$8\pi^2 \lambda^* r^*$ 53.335	$2\pi \lambda^* = 2.568524393 \times 10^{15}$ Monopolar upper classical bound	$8.77 \times 10^{13}$ $9.632 \times 10^{-12}$ $J^*$ 59.96 MeV*	$1.6968 \times 10^{20}$ $K^*$	-	Dirac string modular $R_e$ upper bound
$1.092 \times 10^{-20}$ $5.818 \times 10^{-21}$	$2\pi R_e = 1.74533 \times 10^{-14}$	$4\pi^2 R_e R_e = 37.680$	$2\pi R_e = 2.158884301 \times 10^{15}$	$9.57 \times 10^{13}$ $1.146 \times 10^{-11}$ $J^*$ 71.33 MeV*	$1.9330 \times 10^{20}$ $K^*$	-	
$2.069 \times 10^{-21}$ $1.102 \times 10^{-21}$	$2\pi r^* = 3.30485 \times 10^{-15}$ Monopolar mean quantum bound	$2\pi r^* \lambda^*$ MQB=1.351	$\lambda^* = 4.087933536 \times 10^{14}$ Monopolar mean classical bound	$2.20 \times 10^{20}$ $6.052 \times 10^{-11}$ $J^*$ 376.71 MeV*	$6.7340 \times 10^{20}$ $K^*$	-	Dirac string modular $R^*$ mean
$1.739 \times 10^{-21}$ $9.259 \times 10^{-24}$	$R_e^* = R_e = 10^{10} \lambda_{ps} / 360$	1	$R_e^* = 3.6 \times 10^{14}$ as $360 \times R_e \times 10^{12} = 1/R_e^*$	$2.40 \times 10^{20}$ $7.200 \times 10^{-11}$ $J^*$ 448.19 MeV*	$7.6713 \times 10^{20}$ $K^*$	-	
$1.739 \times 10^{-21}$ $9.259 \times 10^{-24}$	$R_e = 2.77777 \times 10^{-15}$ Electron charge radius for electron degeneracy	$R_e R_e = 0.9544$	$R_e = 3.43597108 \times 10^{14}$	$2.40 \times 10^{20}$ $7.200 \times 10^{-11}$ $J^*$ 448.19 MeV*	$7.6713 \times 10^{20}$ $K^*$	-	
$1.075 \times 10^{-21}$ $5.723 \times 10^{-24}$	$XR_e = 1.716761 \times 10^{-15}$ $=\sqrt[3]{A}$ for $A=5(2X+1)^2$ Atomic radius for nucleus $XR_e/MQB=1.2707 \sqrt[3]{A}$ with A the atomic number	0.3645 6	$2.1235470 \times 10^{14}$	$3.05 \times 10^{20}$ $1.165 \times 10^{-10}$ $J^*$ 725.19 MeV*	$1.1006 \times 10^{21}$ $K^*$	-	
$8.693 \times 10^{-22}$ $4.630 \times 10^{-24}$	$\frac{1}{2}XR_e = 1.38885 \times 10^{-15}$ $\frac{1}{2}(X+\frac{1}{2}X)R_e = \frac{3}{4}XR_e = 1.2875 \times 10^{-15}$ $\sim XR_e/MQB$	0.2386 $\sim \sqrt[3]{X}$	$1.7179379 \times 10^{14}$	$3.39 \times 10^{20}$ $1.440 \times 10^{-10}$ $J^*$ 896.41 MeV*	$1.2902 \times 10^{21}$ $K^*$	-	
$5.373 \times 10^{-22}$ $2.861 \times 10^{-24}$	$\frac{1}{2}XR_e = 8.583806 \times 10^{-16}$ Proton charge radius for neutron degeneracy	0.0911	$1.06177383 \times 10^{14}$	$4.31 \times 10^{20}$ $2.330 \times 10^{-10}$ $J^*$ 1.450 GeV*	$1.8508 \times 10^{21}$ $K^*$	-	
$3.292 \times 10^{-22}$ $1.753 \times 10^{-24}$	$r^* = R_e R^* / R_e = 5.2598 \times 10^{-16}$ Monopolar lower quantum bound	$r^* R^* = 0.0342$	$R^* = \lambda^* / 2\pi = 6.506148293 \times 10^{13}$ Monopolar lower classical bound	$5.51 \times 10^{20}$ $3.802 \times 10^{-10}$ $J^*$ 2.367 GeV*	$2.6725 \times 10^{21}$ $K^*$	-	Dirac string modular $R_e$ lower bound



2.767x10 <sup>-22</sup> 1.474x10 <sup>-24</sup>	$R_u/2\pi=$ $R_u/2\pi=4.42097x10^{-10}$	$R_t R_u/4$ $\pi^2$ 0.0242	$R_t/2\pi=5.468517817$ $x10^{13}$	6.01x10 <sup>21</sup> 4.524x10 <sup>10</sup> J* 2.816 GeV*	3.0445x10 <sup>11</sup> K*	-	
1.746x10 <sup>-24</sup> 9.300x10 <sup>-27</sup>	$\lambda_{cr}=(R_t/R_c)R_u=2.78999$ $0x10^{-18}$ $r_t=4.4404070x10^{-10}$	9.63x1 0 <sup>7</sup>	$R_c=\sqrt{F}(\lambda_{mon}/2\pi)$ $=3.45107750x10^{11}$ 1150.36 s*	7.57x10 <sup>21</sup> (7.168- 1.141)x10 <sup>8</sup> J* (446.23- 71.02) GeV*	1.3598x10 <sup>11</sup> K*	-	Higgs Boson 71.020Y <sup>10</sup> =122.49 GeV* 122.19 GeV RMP -dark matter deficit=122.49/123.57= 0.9913
1.731x10 <sup>-24</sup> 9.220x10 <sup>-27</sup>	2.7659325x10 <sup>-18</sup> 4.4021183x10 <sup>-10</sup>	9.46x1 0 <sup>7</sup>	3.42132x10 <sup>11</sup> 1140.44 s*	7.60x1021 (7.231- 1.151)x10 <sup>8</sup> J* (450.11- 71.64) GeV*	1.3687x10 <sup>11</sup> K*	-	Higgs Boson 71.64Y <sup>10</sup> =123.56 GeV* 123.25 GeV Mean $\Delta$ time $\frac{1}{2}(F-G)=9.92$ s*
1.716x10 <sup>-24</sup> 9.140x10 <sup>-27</sup>	$\lambda_{cr}=(R_t/R_c)R_u=2.74187$ $2x10^{-18}$ $r_t=4.36382482x10^{-10}$	9.30x1 0 <sup>7</sup>	$R_c=\sqrt{G}(\lambda_{mon}/2\pi)$ $=3.39155801x10^{11}$ 1130.52 s*	7.63x10 <sup>21</sup> (7.294- 1.161)x10 <sup>8</sup> J* (454.06- 72.266) GeV*	1.3776x10 <sup>11</sup> K*	-	Higgs Boson 72.266Y <sup>10</sup> =124.64 GeV* 124.33 GeV Higgs neutrino: $m_{\nu_i}=m_{\nu_j}(R_t/R_c-$ $R_c/R_u)/R_u=9.305x10^{-18}$ kg* 0.052 eV* neutrino mass induction 2.969- 3.021 eV*
1.702x10 <sup>-24</sup> 9.065x10 <sup>-27</sup>	2.719631x10 <sup>-18</sup> 4.3284271x10 <sup>-10</sup>	9.14x1 0 <sup>7</sup>	3.364047x10 <sup>11</sup> 1121.35 s*	7.665x10 <sup>21</sup> (7.354- 1.170)x10 <sup>8</sup> J* (457.77- 72.857) GeV*	1.3861x10 <sup>11</sup> K*	-	125.66 GeV* 125.35 GeV 1 eV*= 0.997540464 eV <sub>0</sub> 1 s* = 0.999022562 s <sub>0</sub> 1 kg*=0.996260907 kg <sub>0</sub>
1.701x10 <sup>-24</sup> 9.0575x10 <sup>-27</sup>	2.716941x10 <sup>-18</sup> 4.324146x10 <sup>-10</sup>	9.06x1 0 <sup>7</sup>	3.336072x10 <sup>11</sup> 1120.24 s*	7.668x10 <sup>21</sup> (7.361- 1.172)x10 <sup>8</sup> J* (458.23- 72.93) GeV*	1.3870x10 <sup>11</sup> K*	-	Higgs Boson 72.93Y <sup>10</sup> =125.78 GeV* 125.48 GeV RMP -dark matter excess=126.95/125.78 =1.0093 Mean $\Delta$ time $\frac{1}{2}(G-F)=10.28$ s*
1.685x10 <sup>-24</sup> 8.973x10 <sup>-27</sup>	$\lambda_{cr}=(R_t/R_c)R_u=2.6920$ $0x10^{-18}$ $r_t=4.4404070x10^{-10}$	8.96x1 0 <sup>7</sup>	$R_c=\sqrt{F'}(\lambda_{mon}/2\pi)$ $=3.32987275x10^{11}$ 1109.96 s*	7.70x10 <sup>21</sup> (7.429- 1.182)x10 <sup>8</sup> J* (462.47- 73.605) GeV*	1.3966x10 <sup>11</sup> K*	-	Higgs Boson 73.605Y <sup>10</sup> =126.95 GeV* 126.64 GeV Blueprint for neutron decay: $\lambda_{cr}-2\pi\lambda_{mon}$ (1109.96-229.82) s* = 880.14 s*/879.28 s
1.331x10 <sup>-24</sup> 7.088x10 <sup>-27</sup>	2.1264802x10 <sup>-18</sup> Higgs monopolar mean quantum bound from G as dineutron	5.59x1 0 <sup>7</sup> 0.7755 58	2.6303496x10 <sup>11</sup> 876.78 s*	8.67x10 <sup>21</sup> 9.405x10 <sup>8</sup> J* 585.46 GeV*	1.6668x10 <sup>11</sup> K*	-	
3.489x10 <sup>-24</sup> 1.858x10 <sup>-27</sup>	$2\pi\lambda_{RMP}=4\pi^2 R_{RMP}=5.57$ 389763x10 <sup>-23</sup>	3.84x1 0 <sup>8</sup>	$R_{neutrondecay}=6.89463$ 23x10 <sup>10</sup> 229.82 s*	1.69x10 <sup>22</sup> 3.588x10 <sup>7</sup> J* 2.234 GeV*	4.5500x10 <sup>11</sup> K*	-	Modular RMP perimeter for primordial neutron decay (1109.96- 229.82)s*=880.14 s* 879.28 s 1 <sup>11</sup> particular neutron twin is born from ylem neutron to blueprint primordial neutron decay

$9.475 \times 10^{-28}$ $t_{pl}^2/t_{XL}$ $=5.046 \times 10^{-28}$	$R_{XL}=2\pi L_{XL}=1.514 \times 10^{-19}$ $L_{XL}=r_{XL}=2.410 \times 10^{-20}$	$2.84 \times 1$ $0^0$	$1.87274220 \times 10^{20}$	$3.25 \times 10^{-22}$ $1.321 \times 10^{-6}$ $J^*$ $8.223 \text{ TeV}^*$	$1.2094 \times 10^{18}$ $K^*$	-	Image of XL boson string Scale of RMP-photon
$5.553 \times 10^{-28}$ $2.957 \times 10^{-28}$	$\lambda_{RMP}=2\pi R_{RMP}=8.8711$ $3360 \times 10^{-30}$	$9.73 \times 1$ $0^{10}$	$1.09731481 \times 10^{20}$	$4.24 \times 10^{-22}$ $2.255 \times 10^{-6}$ $J^*$ $14.034$ $\text{TeV}^*$	$1.8057 \times 10^{18}$ $K^*$	-	$\lambda_{RMP}=2\pi R_{RMP}$ dark matter particle $1^{st}$ wave matter neutron twin is born from ylem neutron in radial manifestation
$3.153 \times 10^{-28}$ $t_{pl}^2/t_{EC}$ $=1.679 \times 10^{-28}$	$R_{EC}=2\pi L_{EC}=5.037 \times 10^{20}$ $L_{EC}=r_{EC}=8.017 \times 10^{-21}$	$3.14 \times 1$ $0^{10}$	$6.23051682 \times 10^9$	$5.63 \times 10^{-22}$ $3.971 \times 10^{-6}$ $J^*$ $24.717$ $\text{TeV}^*$	$2.7604 \times 10^{18}$ $K^*$	-	Image of EC boson string Scale of RMP photon
$8.837 \times 10^{-27}$ $4.706 \times 10^{-29}$	$R_{RMP}=1.411884763 \times 10^{20}$	$2.47 \times 1$ $0^{11}$	$1.74643077 \times 10^9$	$1.06 \times 10^{-1}$ $1.417 \times 10^{-5}$ $J^*$ $88.178$ $\text{TeV}^*$	$7.1661 \times 10^{18}$ $K^*$	-	$R_{RMP} = \sqrt[3]{(e^* \cdot dt_{pl}/d_{RMP})_{\text{minimum}}/2\pi^2}$ $= \sqrt[3]{(e^*/2\pi^2)/(9 \times 10^{20})}$ $Y^2 M^2 C^2$ quark geometric template for lefthanded ylemic neutron boson as precursor for fermionic Higgs Boson template
$4.465 \times 10^{-27}$ $R_{HIGGS} \cdot t_{pl}/G \cdot M_{pl}$ $=2.378 \times 10^{-29}$	$R_{HIGGS}=2\pi L_{HIGGS}=7.134 \times 10^{21}$ $L_{HIGGS}=r_{HIGGS}=1.135 \times 10^{21}$	$6.30 \times 1$ $0^{12}$	$8.82440084 \times 10^8$	$1.50 \times 10^{-1}$ $2.803 \times 10^{-5}$ $J^*$ $174.51$ $\text{TeV}^*$	$1.1958 \times 10^{21}$ $K^*$	-	False Higgs Vacuum min in spacetime
$7.327 \times 10^{-28}$ $t_{pl}/V\alpha$ $=3.902 \times 10^{-30}$	$R_{HIGGS}=2\pi L_{HIGGS}=1.171 \times 10^{21}$ $L_{HIGGS}=r_{HIGGS}=1.864 \times 10^{22}$	$1.70 \times 1$ $0^{13}$	$1.44846837 \times 10^8$	$3.69 \times 10^{-1}$ $1.708 \times 10^{-4}$ $J^*$ $1063.17$ $\text{TeV}^*$	$4.6379 \times 10^{15}$ $K^*$	-	False Higgs Vacuum max in spacetime
$3.933 \times 10^{-38}$ $2.094 \times 10^{-30}$	$2\pi \lambda_{QBS}=6.283 \times 10^{-22}$	$4.88 \times 1$ $0^{14}$	$7.77175644 \times 10^7$	$5.04 \times 10^{-1}$ $3.183 \times 10^{-4}$ $J^*$ $1981.44$ $\text{TeV}^*$	$7.3956 \times 10^{21}$ $K^*$	-	Modular QBBS wormhole perimeter
$n_{pl}=6.259 \times 10^{-69}$ $t_{pl}=3.333 \times 10^{-31}$	$\lambda_{QBS}=10^{-22}$	$1.24 \times 1$ $0^{15}$	$1.23694994 \times 10^7$	$1.26 \times 10^{-1}$ $2 \times 10^{-3} J^*$ $12,449.76$ $\text{TeV}^*$	$2.2935 \times 10^{15}$ $K^*$ $T_{pl}=1.4167 \times 10^{20} K^*$	-	wormhole temperature < universe temperature $T_{pl}=E_{pl}/k_B=1.4167 \times 10^{20} < T(n_{pl})=2.935177 \times 10^{16} K^*$
$9.962 \times 10^{-30}$ $5.305 \times 10^{-32}$	$r_{pl}=\lambda_{QBS}/2\pi=1.592 \times 10^{23}$	$3.14 \times 1$ $0^{17}$	$1.96922430 \times 10^8$	$3.17 \times 10^{-1}$ $0.01257 J^*$ $78,224.17$ $\text{TeV}^*$	$8.9040 \times 10^{21}$ $K^*$	-	Modular QBBS wormhole radius
$5.346 \times 10^{-20}$ $V\alpha \cdot t_{pl}$ $=2.847 \times 10^{-27}$	$R_{HIGGS}=2\pi L_{HIGGS}=8.541 \times 10^{24}$ $L_{HIGGS}=r_{HIGGS}=1.359 \times 10^{26}$	$9.02 \times 1$ $0^{18}$	$1.0564789 \times 10^8$	$4.33 \times 10^{-1}$ $0.02342 J^*$ $1.4576 \times 10^5$ $\text{TeV}^*$	$T_{HIGGS}=1.6590 \times 10^{21} K^*$	-	False Higgs Vacuum max in timespace
$8.773 \times 10^{-21}$ $G \cdot M_{pl} \cdot t_{pl}/R_H$ $=4.672 \times 10^{-31}$	$R_{HIGGS}=2\pi L_{HIGGS}=1.402 \times 10^{24}$ $L_{HIGGS}=r_{HIGGS}=2.231 \times 10^{25}$	$2.43 \times 1$ $0^{19}$	$173,420.38$	$1.07 \times 10^{-1}$ $0.14265 J^*$ $8.8800 \times 10^5$ $\text{TeV}^*$	$T_{HIGGS}=1.0105 \times 10^{22} K^*$	-	False Higgs Vacuum min in timespace

$1.243 \times 10^{-24}$ $2\pi R_{EC}/c$ = $6.618 \times 10^{-24}$	$R_{EC}=2\pi L_{EC}=1.985 \times 10^{25}$ $L_{EC}=r_{EC}=3.159 \times 10^{26}$	$4.87 \times 10^{21}$	24,553.46	$2.84 \times 10^{23}$ $0.9925 J^*$ $6.272 \times 10^6$ TeV*	$T_{EC}=7.0304 \times 10^{22} K^*$	-	EC-Boson string $B(0)=(2e/h\lambda)e^{-\alpha_2(n+1)}$
$4.135 \times 10^{-27}$ $2\pi R_{XL}/c$ = $2.202 \times 10^{-29}$	$R_{XL}=2\pi L_{XL}=6.606 \times 10^{31}$ $L_{XL}=r_{XL}=1.051 \times 10^{31}$	$4.95 \times 10^{32}$	0.0817	$1.56 \times 10^{33}$ $302,755.07$ $J^*$ $1.885 \times 10^{12}$ TeV*	$T_{XL}=2.1446 \times 10^{28} K^*$	-	XL-Boson string
$2.886 \times 10^{-28}$ $2\pi R_{MD}/c$ $1.537 \times 10^{-22}$	$R_{MD}=2\pi L_{MD}=4.611 \times 10^{32}$ $L_{MD}=r_{MD}=7.339 \times 10^{33}$	$2.63 \times 10^{34}$	$5.704 \times 10^{33}$	$5.89 \times 10^{33}$ $4.337 \times 10^6$ $J^*$ $2.700 \times 10^{13}$ TeV*	$T_{MD}=3.0721 \times 10^{29} K^*$	-	Monopole $[ec]_{max}$ in timespace manifests in quantum mechanics in spacetime as 't Hooft-Polyakov GUT monopole lower limit
$9.621 \times 10^{-22}$ $2\pi R_{MD}/c$ $5.124 \times 10^{-12}$	$R_{MD}=2\pi L_{MD}=1.537 \times 10^{33}$ $L_{MD}=r_{MD}=2.446 \times 10^{34}$	$2.92 \times 10^{37}$	$1.9012 \times 10^{-4}$	$3.22 \times 10^{33}$ $1.303 \times 10^6$ $J^*$ $8.100 \times 10^{16}$ TeV*	$T_{MD}=9.2157 \times 10^{31} K^*$	-	Monopole $[30ec]_{max}$ in timespace manifests in quantum mechanics in spacetime as 't Hooft-Polyakov GUT monopole upper limit
$8.219 \times 10^{-11}$ $2\pi R_{PL}/c$ $4.377 \times 10^{-13}$	$R_{PL}=2\pi L_{PLmax}=1.313 \times 10^{34}$ $L_{PLmax}=r_{PL}=2.090 \times 10^{35}$	$2.13 \times 10^{30}$	$1.6241 \times 10^{-5}$	$1.10 \times 10^{33}$ $1.523 \times 10^0$ $J^*$ $9.482 \times 10^{15}$ TeV*	$T_{PL}=1.0788 \times 10^{32} K^*$	-	Planck boson string
$7.021 \times 10^{-11}$ $2\pi e/c^2 = v/\alpha$ $\tau_{PL}$ = $3.739 \times 10^{-44}$	$R_{OPL}=2\pi L_{OPL}=1.122 \times 10^{35}$ $L_{OPL}=r_{OPL}=v\alpha L_{q\text{brek}}=1.786 \times 10^{36}$	$1.56 \times 10^{41}$	$1.3879 \times 10^{-6}$	$3.77 \times 10^{33}$ $1.783 \times 10^{10}$ $J^*$ $1.110 \times 10^{17}$ TeV*	$T_{OPL}=1.2630 \times 10^{33} K^*$	-	Planck bounce boson string
$\pi_{ALGO}$ $H_0 t_{ALGO}$ = $H_0 \pi_{PL}$ $1.175 \times 10^{66}$ $\pi_{PL}$ $H_0 t_{PL}=\lambda_{qis}/R$ $6.259 \times 10^{-62}$	$R_{ALGO}=2\pi L_{ALGO}=1.878 \times 10^{40}$ $L_{ALGO}=r_{ALGO}=2.989 \times 10^{41}$	$4.36 \times 10^{51}$	$2.32299 \times 10^{11}$	$9.23 \times 10^{32}$ $1.065 \times 10^{15}$ $J^*$ $6.629 \times 10^{21}$ TeV*	$T_{ALGO}=7.544 \times 10^{37} K^*$	-	First Logos mathimatia definition in timespace to manifest universal life in spacetime wavelength $\lambda_{qis}$ linearized as radius $R_{ALGO}=2\pi r_{ALGO}$ for QBBS as $r_{qis}=\lambda_{qis}/2\pi$



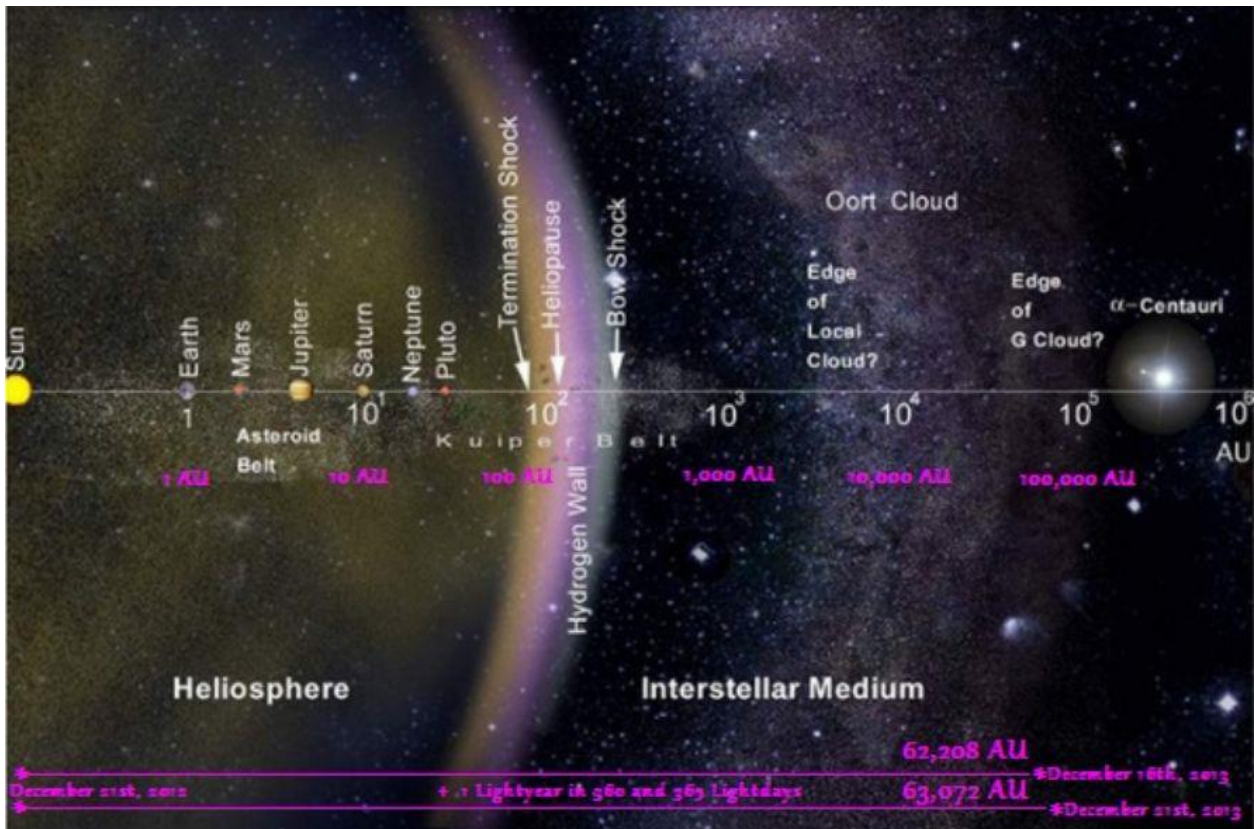
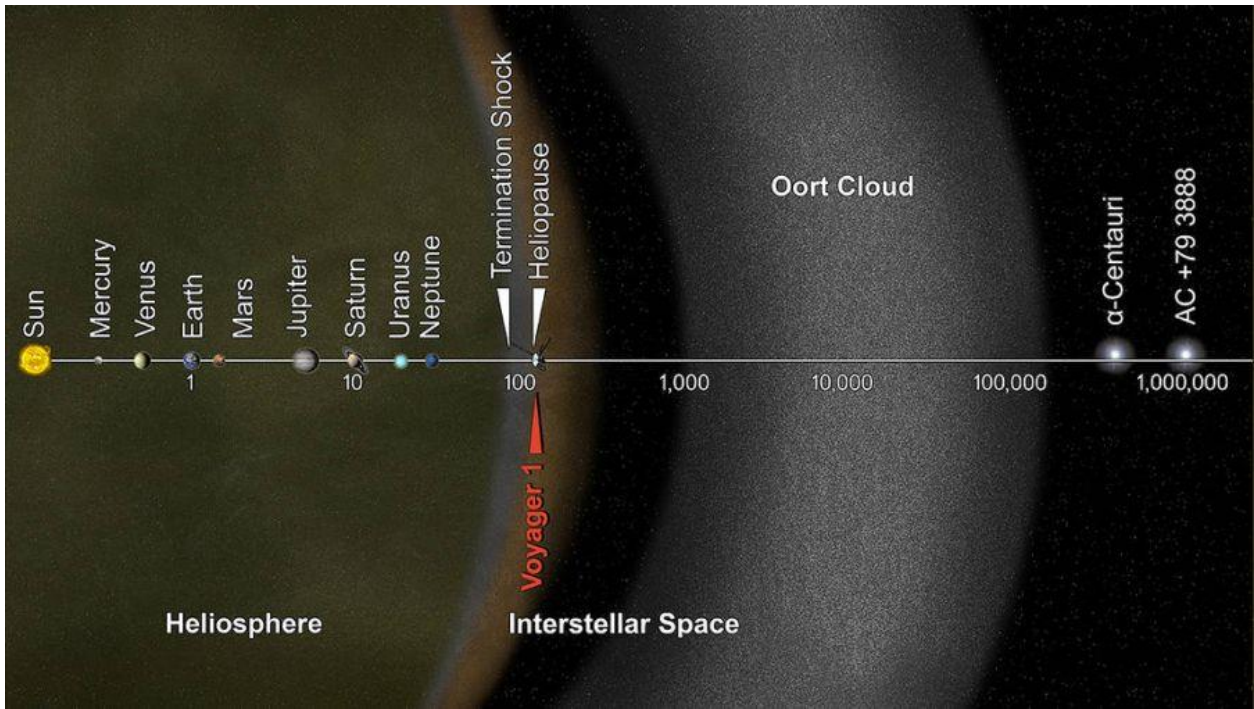

A general dark energy equation for the kth universe (k=0,1,2,3,...) in terms of the parametrized Milgröm acceleration A(n); comoving recession speed V(n) and scalefactored curvature radius R(n):  
 $G_0 M_0$  is the Gravitational Parameter for the Baryon mass seed;  $R_H = c/H_0$  is the second nodal Hubble parameter  $H_0$  curvature radius and c is the speed of light

$\Lambda_k(n) = G_0 M_0 / R_k(n)^2 - 2cH_0(\Pi n_k)^2 / \{n - \Sigma \Pi n_{k-1} + \Pi n_k\}^3$       and where  $\Pi n_k = 1 = n_0$  for k=0       $N_k = \frac{H_0 t_k}{\Pi n_k} = \frac{n - \Sigma \Pi n_{k-1}}{\Pi n_k}$   
 $R_k(n) = \Pi n_k R_H (n - \Sigma \Pi n_{k-1}) / \{n - \Sigma \Pi n_{k-1} + \Pi n_k\} = R_H (n / (n+1)) = n_1 R_H (N_1 / (N_1+1)) = n_1 n_2 R_H (N_2 / (N_2+1)) = \dots$   
 $V_k(n) = dR_k(n) / dt \dots = c \{ \Pi n_k \}^2 / \{n - \Sigma \Pi n_{k-1} + \Pi n_k\}^2 = c / (n+1)^2 = c / (N_1+1)^2 = c / (N_2+1)^2 = \dots$   
 $A_k(n) = d^2 R_k(n) / dt^2 \dots = -2cH_0 (\Pi n_k)^2 / (n - \Sigma \Pi n_{k-1} + \Pi n_k)^3 = -2cH_0 / (n+1)^3 = -2cH_0 / n_1 (N_1+1)^3 = -2cH_0 / n_1 n_2 (N_2+1)^3 = \dots$

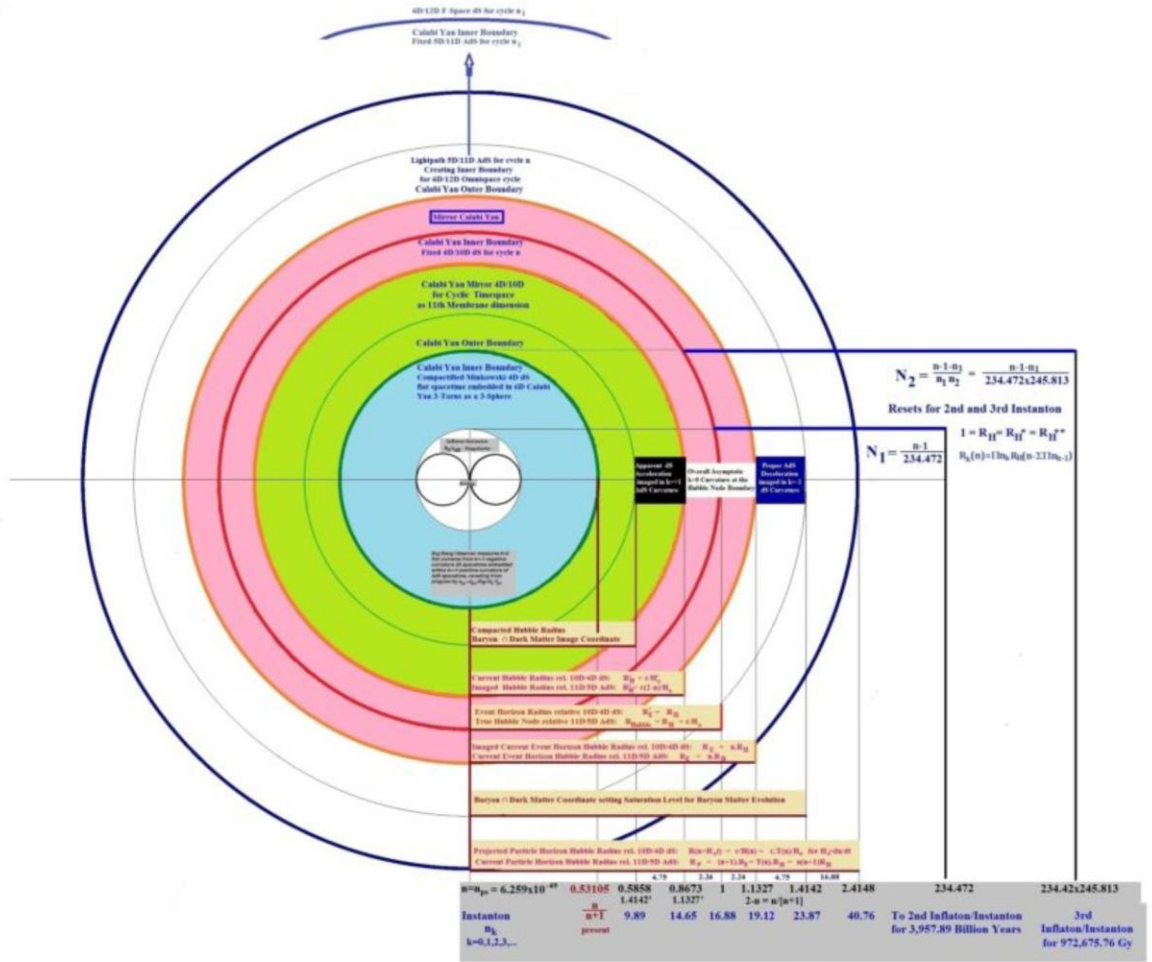

### The Multiverse and the Evolution of Mass in Hypermass

This evolution of mass as a fundamental cosmological parameter relates to the 'missing' mass in the  $M_0/M_H = 0.02803...$  ratio say as the Omega of the deceleration parameter  $q_0 = 1/2 \Omega_0$  in the Friedmann cosmology. Considering a time evolution of a rest mass seedling  $M_0$  towards a Black Hole closure mass  $M_H$  in the form of 'massless eternal Strominger branes' will crystallize the existence of a multiverse as a function of the wormhole radius  $r_{ps}$  expanding in higher dimensional brane spacetime until the Hubble radius  $R_H$  is reached in a time of about 4 trillion years.

A formula to describe this is:  $\ln Y = \ln(R_H/r_{ps})$  or equivalently  $\ln Y = \ln(M_H/M_{\text{curvature}})$  for the quantum gravitational transformation of the Planck mass into the curvature mass of 6445.775... kg\* as the minimum mass a Black Hole can have in the quantum relativistic cosmology.

When a Strominger eternal (there is no Hawking radiation) black hole has reached its macro state from its microstate, say after 234.47 cycles in a protoverse, then the entire old universe will quantum tunnel into a new universe which was born as a multiverse at the completion of the first cycle for  $n=1$  and when a second inflaton holographically repeated the cosmogenesis parallel in time but not in space to ensure the eternal continuity for the first universe created as a protoverse.

The quantum tunneling wall so is an interval of time defined in  $n_{ps}$  and not any boundary in space.

Radius of Curvature  $r(n)$  with Salefactor  $1/a=1+1/n$  in  $dS$  as a function of cyclotime coordinate  $n$

$$r(n) = r_{\text{max}} \left( \frac{n}{n+1} \right) m^* \quad \text{and} \quad n = H_0 t$$

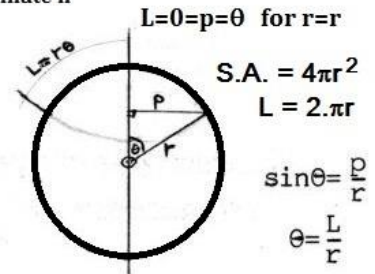

The volume of the 4-D spacetime can however be found by integrating the surface area S.A. via arclength  $L$ , with  $L$  being an intrinsic parameter of the 3-D surface.  $dL=r \cdot d\theta$

$$V_{\text{Universe}} = \int_0^{r\pi} 4\pi r^2 dL = 2\pi^2 r(n)^3 \quad \text{for a local spheroidicity}$$

$$4\pi \int_0^\pi r^3 \sin^2 \theta d\theta = 4\pi r^3 \int_0^\pi \frac{1}{2} \{1 - \cos 2\theta\} d\theta = 2\pi^2 r(n)^3 \quad \text{for the asymptotic 4/10D } dS \text{ 'flatness' cosmology within the nodal Hubble 5/11D AdS Universe}$$

This classical macrovolumar is quantized in the microvolumar quantum of the Unified Field in  $8\pi$  radians or  $840^\circ - (-600^\circ) = 1440^\circ$

$$\begin{aligned} & \frac{1}{4}\pi \int_{-600^\circ}^{840^\circ} \{ \sin(\frac{1}{2}[3x]) - \cos(\frac{1}{4}[3x]) \}^2 dx = \frac{1}{4}\pi \int_{-10\pi/3}^{14\pi/3} \{ \sin^2(3x/2) + \cos^2(3x/4) - 2\sin(3x/2)\cos(3x/4) \} dx \\ & = \frac{1}{4}\pi \int_{-600^\circ}^{840^\circ} \{ \frac{1}{2}(1 - \cos[3x]) + \frac{1}{2}(1 + \cos\frac{1}{2}[3x]) - \sin\frac{1}{2}[9x] \cdot \sin\frac{1}{4}[3x] \} dx \quad \left\{ \begin{array}{l} \text{by classical volumar of revolution (vor)} \\ V_{\text{vor}} = \int \pi y^2 dx \quad \text{for } y=r \end{array} \right\} \\ & = \frac{1}{4}\pi \left[ \theta - \sin[3x]/6 + \sin\frac{1}{2}[3x]/3 - 2\cos\frac{1}{2}[9x]/9 - 2\cos\frac{1}{2}[3x]/3 \right]_{-10\pi/3}^{14\pi/3} = \frac{1}{4}\pi(8\pi) = 2\pi^2 \end{aligned}$$

The amplitude for the universal wavefunction becomes proportional to the quantum count of the space occupancy of a single spacetime quantum and as source energy (VPE or Vortex Potential Energy) quantum and as a consequence of the preinflationary supersymmetry of the  $F(x) = \sin x + \sin(-x) = 0$  wavefunction defining this singularity (symbolised as the symbol for infinity).

A higher dimensional surface is Moebian connected to differentiate the quantum mechanical 'boundary' for the quantum tunneling of the macrocosmos as a magnified holofractal of the well understood microquantumization.

It then is the experienced and measured relativity of time itself, which becomes the quantum wall, with the 'reducing thickness' of the quantum boundary correlating with the evolution of the multiversal structure in the phase shifted time intervals defining the individual universes.

<https://youtu.be/RF7dDt3tVml>

The Hubble Event Horizon  $R_{HEH} = R_{EH} = nR_H$  so manifests the AdS spacetime of the EMMR refractive Lightpath and the nodal Hubble minimum  $R_H$  forms the upper boundary for the cyclic dS spacetime in the reflective EMR Lightpath of the lower dimensional cosmology lower bounded by the wormhole QBBS frequency  $f_{ps}=1/f_{ss}$  and coupled in lightspeed invariance as  $\lambda_{ps}.f_{ps} = c = R_H.H_0$ .

The mass evolution of baryon seedling  $M_o$  so is described in both a cyclic and spheroidal-positively curved de Sitter spacetime and in a continuous and hyperbolic-negatively curved Anti de Sitter spacetime in the EMMR and EMR Lightpath respectively.

The hypermass form of the mass seedling  $M_o$  as a Strominger brane requires 234.47  $R_H$ -cycles to satisfy the  $M_H$  boundary condition in synchronization with the curvature radius of the QBBS attaining the displacement scale of the Hubble radius and a critical radius made manifest by the EMMR Lightpath after just one cycle at  $n=1$  for the AdS cosmology, a nexus for which the dS spacetime for the expanding universe has reached the halfway coordinate  $n=1/2$  in the gravitationally retarded cosmology.

In AdS spacetime then, the Strominger 'Mother Black Hole' boundary  $M_H$  increases as  $nM_H=M_{HEH}=nR_{HC}^2/2G_o$  and is so  $1.1327127..M_H = 7.3293 \times 10^{52} \text{ kg}^*$  for the present  $n$ -cycle time coordinate and will be  $n_1M_H=234.47M_H$  or  $1.517 \times 10^{55} \text{ kg}^*$  at the completion of the first time-spaced universe 4 trillion years after the QBBS by  $n = \ln\{R_H/r_{ps}\}/\ln Y = \ln\{2\pi/n_{ps}\}/\ln Y = 234.47161$  in  $234.47161/H_0 = 234.47161R_H/c = 1.24870 \times 10^{20} \text{ s}^*$  or 3.9570 trillion years.

The baryonic mass seedling  $M_o$  as a hypermass in AdS cosmology attains saturation potential for the Strominger Sarkar 'Daughter Black Hole'  $n_{Sarkar}M_H = n_{Sarkar}R_{HC}^2/2G_o = \Omega_o R_{HC}^2/2G_o = 1.81371262 \times 10^{51} \text{ kg}^*$  for  $M_o = R_{SarkarAdS}M_H/R_H$  and  $R_{SarkarAdS} = 4.478303 \times 10^{24} \text{ m}^*$

As a distributed baryon mass in dS cosmology,  $R_{Sarkar}(n_{Sarkar}) = \{n_{Sarkar}/[1+n_{Sarkar}]\}R_H = 4.356356 \times 10^{24} \text{ m}^*$  for  $M_{Sarkar} = R_{SarkarAdS}c^2/2G_o = 1.764324 \times 10^{51} = M_o \text{ kg}^*$  and for  $n_{Sarkar} = \Omega_o = 0.028030116$

This implies, that  $1.764324/1.813713$  or 97.277% of  $M_o$  has inertialized-materialized from its hypermass potential from the initial boundary condition of the deceleration parameter  $q_o=1/2\Omega_o$  as gravitational mass equivalent at the  $n_{Sarkar} = \Omega_o$  coordinate at  $2 \times 236.57 = 473.14$ -Million-year marker of the galactic supercluster displacement scale.

The Hubble law so modulates the inflaton as the instanton in a dimensionless cycle time parameter  $n$  in a time rate change constant as the nodal Hubble constant  $H(n)|_{\min} = H_o = 58.04 \text{ km/Mpc.s}$  (extrapolated to  $66.9 \text{ km/Mpc.s}$  for a present  $n_{\text{present}} = 1.1327127...$  cycle time coordinate) and in inverse proportion to its maximum as the wormhole frequency  $f_{ps}$ , becoming the maximum node for  $H(n)$  in the associated multiverse cosmology, which defines this multiverse as parallel in time space, but as holofractally nested in spacetime. It is then a quantum tunneling of the entire universe upon the completion of interwoven cycles defining the nodal oscillations nodal 'walls of time' defined in the light path, which become the medium for this quantum tunneling of lower dimensional spacetime itself.

The 'superluminal' expansion of spacetime of standard cosmology is therefore modified in a decreasing and multiverse generating cyclic Hubble function  $H(n)=H_o/T(n)=H_o/(n[n+1])$  for a projected Particle Hubble Horizon of 40.78 Gy in  $R_p = cT(n)/H_o = n(n+1)R_H = (1.1327127)(2.1327117)(16.88) = 40.77782 \text{ Gy}$  or  $3.85958 \times 10^{26} \text{ m}^*$  as 40.77 billion lightyears for the present protoverse or seedling universe.

A particular unifying n-cycle coordinate is found in the compressed de Sitter spacetime for which the scale factor  $a = R(n)/R_H = n/[n+1] = X = Y - 1$  and so for  $n = X/(1-X) = (Y-1)/(2-Y)$  defines the value of the nodal Hubble constant  $H_0 = c/R_H$  as the Hubble parameter  $H(n=X) = H_0/T(n=X)$  and so for the function  $T(X) = X(X+1) = X^2+X = n^2+n = n(n+1)$  with  $X^2 = 1 - X$  for  $T(n)=1$

A relationship between X and Y is defined in the Euler identity:

$$\exp[i\pi] = X+Y = XY = i^2 = -1 = \cos\pi + i\sin\pi \text{ for the roots of } T(n)=1 \text{ in } X=\pm\frac{1}{2}\{\sqrt{5} - 1\} \text{ and } Y=\pm\frac{1}{2}\{\sqrt{5} + 1\}$$

$$H(X=\frac{1}{2}\{\sqrt{5} - 1\}) = H(0.618034) = H_0/[X][Y] = H_0/1 = H_0 \text{ for scale factor } a = R(n)/R_H = X = 0.618034 = Y - 1$$

The corresponding n-cycle coordinate  $n_{XY} = X/(1-X) = X/X^2 = 1/X = Y = 1.618034$  for

$$R(n=Y) = YR_H/(Y+1) = (\sqrt{5} + 1)R_H/(\sqrt{5} + 3) = \frac{1}{4}R_H(3-\sqrt{5})(1+\sqrt{5}) = \frac{1}{2}R_H(\sqrt{5} - 1) = XR_H = 0.618034R_H$$

The unifying cycle coordinate in the compressed dS spacetime is reached at the X-cycle coordinate in the return of the AdS Lightpath for  $Y=n_{XY}=1.618034$   $Y/H_0=YR_H/c$  or 27.306 billion years from the QBBS

AdS spacetime expands at invariant lightspeed  $c$  and increases the multiversal volumar in the 'event horizon' Hubble horizon  $R_{EH} = nR_H$  in a continuous new spacetime creation of spacetime quanta defined in the Weyl-Eps VPE-ZPE quantum  $V_{ps} = E_{ps}/2\pi^2r_{ps}^3 = 4\pi E_{ps}/\lambda_{ps}^3 = 2.513274 \times 10^{64} \text{ [J/m}^3\text{]}^*$ .

The actual cosmology of the multiverse so exhibits no 'faster than light' spacetime expansion due to spacetime quantization in supermembrane Eps.Ess. The superluminal expansion is restricted to the QBBS parameters of the instanton-inflaton coupling, repeating itself in the cyclicity of the multiverse from the protoversal seed and encompassed by the topology and geometry of the oblate omniverse containing rotational phase shifted prolate universes as multiverses generated from the ellipsoidal foci of the EpsEss or Abba-Baab 12-dimensional cosmogony.

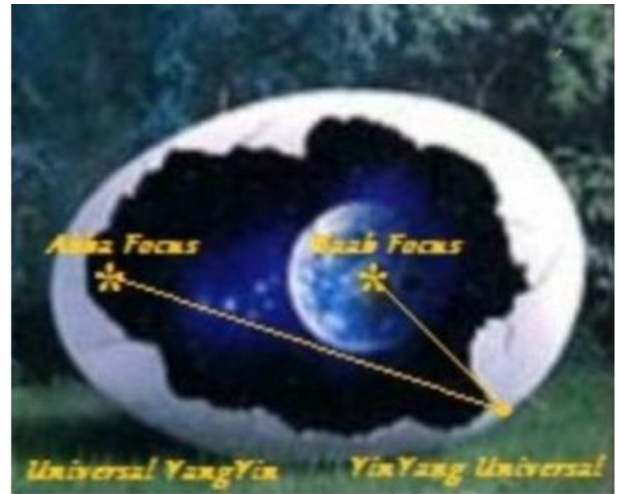
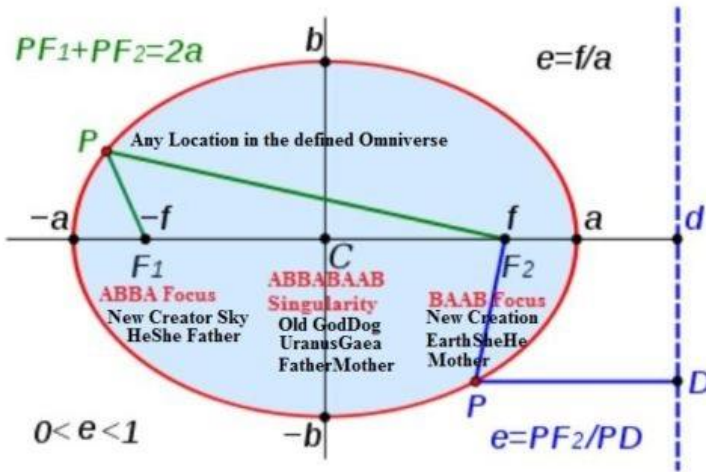

Invariant fixed foci prolate major axis protoverse solid revolution, but a focal point-circle Locus for oblate minor axis multiverse within omniverse solid revolution



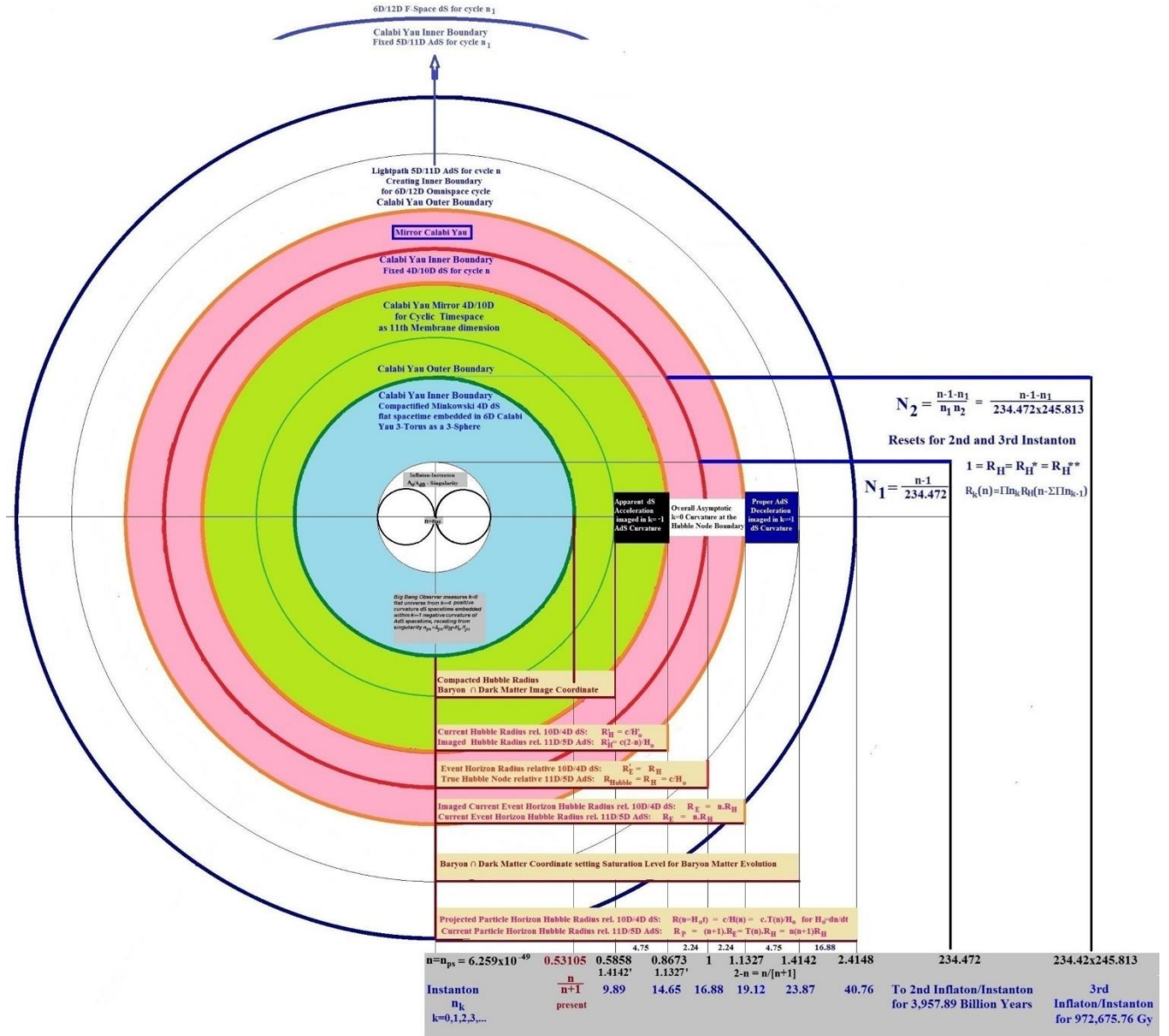

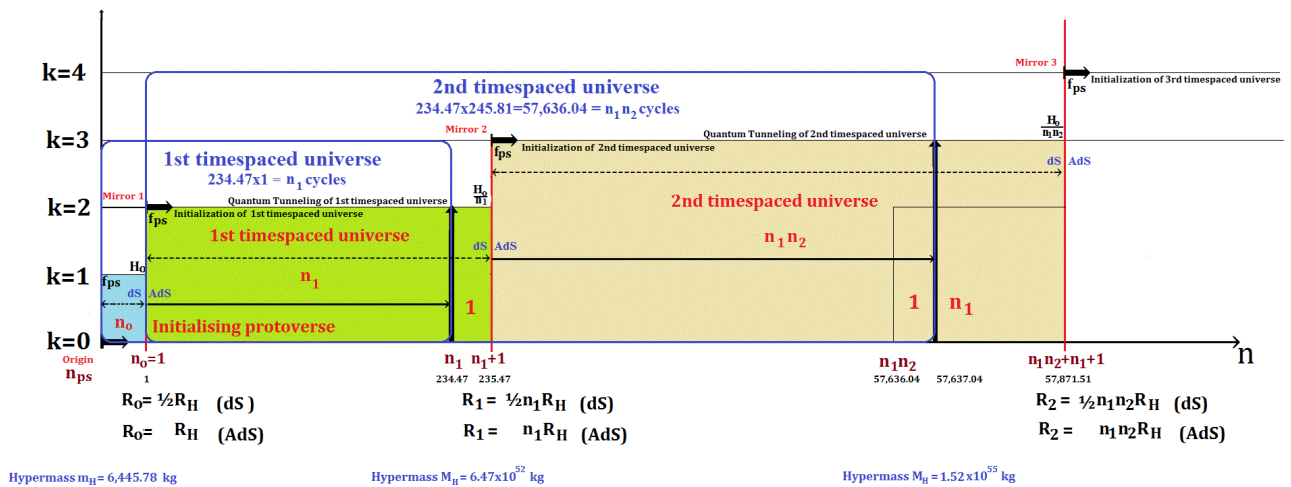
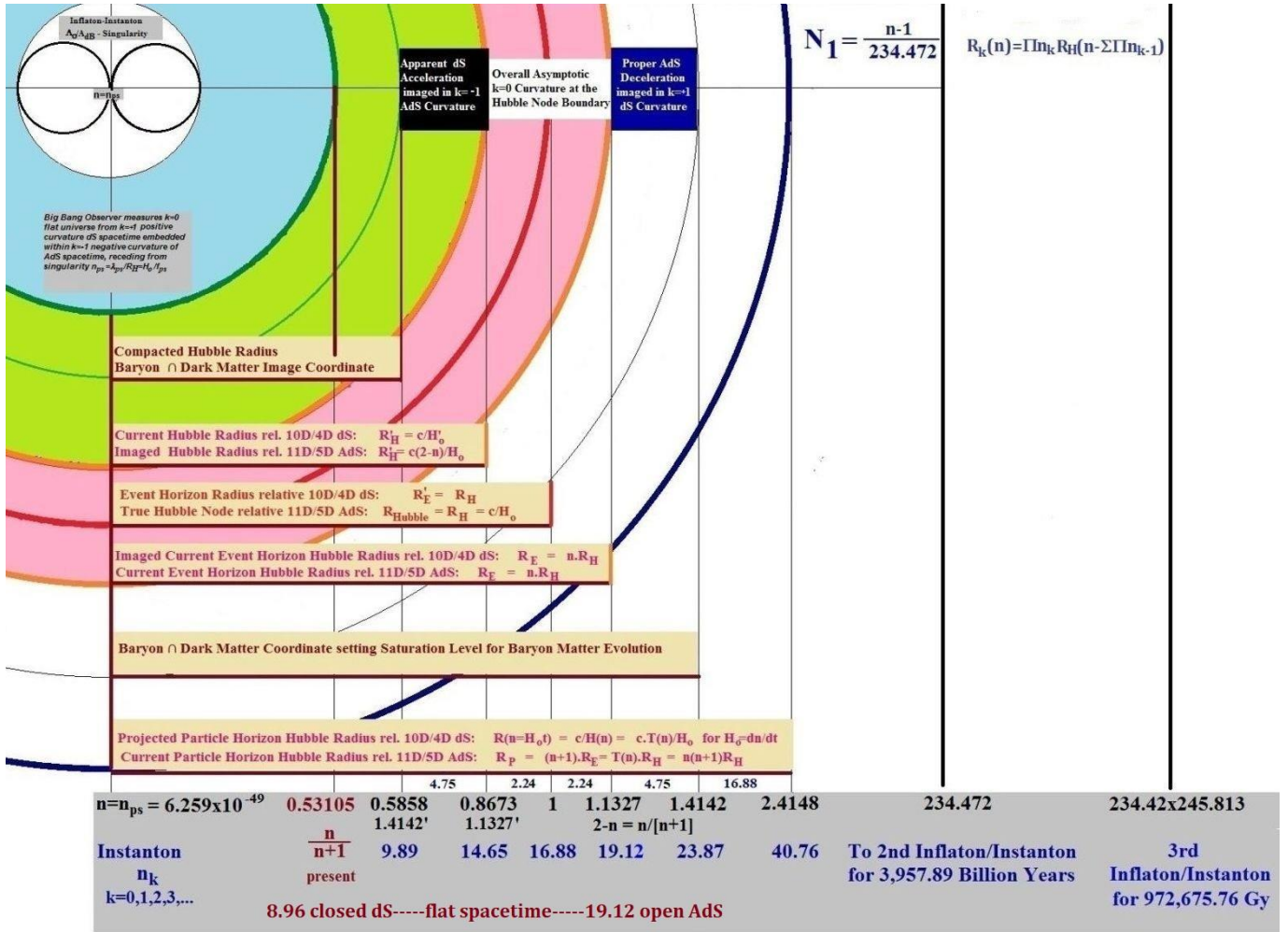

Every Inflaton defines three Hubble nodes or timespace mirrors; the first being the 'singularity - wormhole' configuration; the second the nodal boundary for the 4D/10D dS space-time and the third the dynamic Lightpath bound for the Hubble Event horizon in 5D/11D AdS time-space.

The completion of a 'de Broglie wave matter' evolution cycle triggers the Hubble Event Horizon as the inner boundary of the time-space mirrored Calabi Yau manifold to quantum tunnel onto the outer boundary of the space-time mirrored Calabi Yau manifold in a second universe; whose inflaton was initiated when the light-path in the first universe reached its second Hubble node.

For the first universe, the three nodes are set in time-space as  $\{3.3 \times 10^{-31} \text{ s}; 16.88 \text{ Gy}; 3.96 \text{ Ty}\}$  and the second universe, time shifted in  $t_1 = t_0 + t$  with  $t_0 = 1/H_0$  has a nodal configuration  $\{t_0 + 1.4 \times 10^{-33}; t_0 + 3,957 \text{ Gy}; t_0 + 972.7 \text{ Ty}\}$ ; the latter emerging from the time-space as the instanton at time marker  $t_0$ .

A third universe would initiate at a time coordinate  $t_2 = t_0 + t_1 + t$  as  $\{1/H_0 + 234.472/H_0 + 5.8 \times 10^{-36} \text{ s}; t_0 + t_1 + 972.7 \text{ Ty}; t_0 + t_1 + 250,223 \text{ Ty}\}$ ; but as the second node in the second universe cannot be activated by the Lightpath until the first universe has reached its 3.96 trillion year marker (and at a time for a supposed 'heat death' of the first universe due to exhaustion of the nuclear matter sources); the third and following nested universes cannot be activated until the first universe reaches its  $n=1+234.472=235.472$  time-space coordinate at 3,974.8 billion years from the time instanton aka the Quantum Big Bang.

For a present time-space coordinate of  $n_{\text{present}}=1.13271$  however; all information in the first universe is being mirrored by the time-space of the AdS space-time into the dS space-time of the second universe at a time frame of  $t = t_1 - t_0 = 19.12 - 16.88 = 2.24$  billion years and a multi-dimensional time interval characterizing the apparent acceleration observed and measured in the first universe of the Calabi Yau manifold compressed or compactified flat dS Minkowski cosmology. The solution to the Dark Energy and Dark Matter question of a 'missing mass' cosmology is described in this discourse and rests on the evolution of a multiverse in matter.

$$Y^n = R_{\text{Hubble}}/r_{\text{Weyl}} = 2\pi R_{\text{Hubble}}/\lambda_{\text{Weyl}} = \omega_{\text{Weyl}}/H_0 = 2\pi n_{\text{Weyl}} = n_{\text{ps}}/2\pi = 1.003849 \times 10^{49}$$

with  $n_{\text{ps}} = \lambda_{\text{ps}}/R_{\text{Hubble}} = 6.259093485 \times 10^{-49}$

and with  $k=0$  for  $n_{k-1} = n_{-1} = 0$  and with  $k=1$  for  $n_{k-1} = n_0 = 1$

2nd Inflaton/Quantum Big Bang redefines for  $k=1$ :  $R_{\text{Hubble}(1)} = n_1 R_{\text{Hubble}} = c/H_{0(1)}$   
 $= (234.472)R_{\text{Hubble}} = 3.746 \times 10^{28} \text{ m}^*$  in 3.957 trillion Years for critical  $n_k$

3rd Inflaton/Quantum Big Bang redefines for  $k=2$ :  $R_{\text{Hubble}(2)} = n_1 n_2 R_{\text{Hubble}} = c/H_{0(2)}$   
 $= (234.472)(245.813)R_{\text{Hubble}} = 9.208 \times 10^{30} \text{ m}^*$  in 972.63 trillion Years for critical  $n_k$

4th Inflaton/Quantum Big Bang redefines for  $k=3$ :  $R_{\text{Hubble}(3)} = n_1 n_2 n_3 R_{\text{Hubble}} = c/H_{0(3)}$   
 $= (57,636.27)(257.252)R_{\text{Hubble}} = 2.369 \times 10^{33} \text{ m}^*$  in 250.24 quadrillion Years for critical  $n_k$

5th Inflaton/Quantum Big Bang redefines for  $k=4$ :  $R_{\text{Hubble}(4)} = n_1 n_2 n_3 n_4 R_{\text{Hubble}} = c/H_{0(4)}$   
 $= (14,827,044.63)(268.785)R_{\text{Hubble}} = 6.367 \times 10^{35} \text{ m}^*$  in 67.26 quintillion Years for critical  $n_k$

...

**(k+1)th Inflaton/Quantum Big Bang redefines for  $k=k$ :  $R_{\text{Hubble}(k)} = R_{\text{Hubble}} \prod n_k = c/H_0 \prod n_k$**

.....

$$n_k = \ln\{\omega_{\text{Weyl}} R_{\text{Hubble}(k)}/c\}/\ln Y = \ln\{\omega_{\text{Weyl}}/H_{0(k)}\}/\ln Y$$

$$n_0 = 1$$

$$n_1 = 234.471606...$$

$$n_2 = 245.812422...$$

$$n_3 = 257.251394...$$

$$n_4 = 268.784888...$$

**Dark Energy DE-Quintessence  $\Lambda_k$  Parameters:**

A general dark energy equation for the kth universe (k=0,1,2,3,...) in terms of the parametrized Milgröm acceleration A(n); comoving recession speed V(n) and scale factored curvature radius R(n):

$$\Lambda_k(n) = G_0 M_0 / R_k(n)^2 - 2cH_0(\Pi n_k)^2 / \{n - \Sigma \Pi n_{k-1} + \Pi n_k\}^3 \text{ for negative Pressure } P_k = -\Lambda_k(n)c^2/4\pi G_0 R_k$$

$$= \{G_0 M_0 (n - \Sigma \Pi n_{k-1} + \Pi n_k)^2 / (\Pi n_k)^2 \cdot R_H^2 (n - \Sigma \Pi n_{k-1})^2\} - 2cH_0(\Pi n_k)^2 / \{n - \Sigma \Pi n_{k-1} + \Pi n_k\}^3$$

$$\Lambda_0 = G_0 M_0 (n+1)^2 / R_H^2 (n)^2 - 2cH_0 / (n+1)^3$$

$$\Lambda_1 = G_0 M_0 (n-1+n_1)^2 / n_1^2 R_H^2 (n-1)^2 - 2cH_0 n_1^2 / (n-1+n_1)^3$$

$$\Lambda_2 = G_0 M_0 (n-1-n_1+n_1 n_2)^2 / n_1^2 n_2^2 R_H^2 (n-1-n_1)^2 - 2cH_0 n_1^2 n_2^2 / (n-1-n_1+n_1 n_2)^3$$

.....

**Lambda-DE-Quintessence Derivatives:**

$$\Lambda_k'(n) = d\{\Lambda_k\}/dn =$$

$$\{G_0 M_0 / (\Pi n_k R_H^2)\} \{2(n - \Sigma \Pi n_{k-1} + \Pi n_k) \cdot (n - \Sigma \Pi n_{k-1})^2 - 2(n - \Sigma \Pi n_{k-1}) \cdot (n - \Sigma \Pi n_{k-1} + \Pi n_k)^2\} / \{(n - \Sigma \Pi n_{k-1})^4\} - \{-6cH_0(\Pi n_k)^2\} / (n - \Sigma \Pi n_{k-1} + \Pi n_k)^4$$

$$= \{-2G_0 M_0 / \Pi n_k R_H^2\} (n - \Sigma \Pi n_{k-1} + \Pi n_k) / (n - \Sigma \Pi n_{k-1})^3 + \{6cH_0(\Pi n_k)^2\} / (n - \Sigma \Pi n_{k-1} + \Pi n_k)^4$$

$$= \{6cH_0(1)^2\} / \{(n-0+1)^4\} - \{2G_0 M_0 / 1 \cdot R_H^2\} \{(n-0+1) / (n-0)^3\} \dots \dots \dots \text{ for } k=0$$

$$= \{6cH_0(1 \cdot n_1)^2\} / \{(n-1+n_1)^4\} - \{2G_0 M_0 / n_1 \cdot R_H^2\} \{(n-1+n_1) / (n-1)^3\} \dots \dots \dots \text{ for } k=1$$

$$= \{6cH_0(1 \cdot n_1 \cdot n_2)^2\} / \{(n-1-n_1+n_1 \cdot n_2)^4\} - \{2G_0 M_0 / n_1 n_2 \cdot R_H^2\} \{(n-1-n_1+n_1 n_2) / (n-1-n_1)^3\} \dots \dots \dots \text{ for } k=2$$

....

$$\text{For } k=0; \{G_0 M_0 / 3c^2 R_H\} = \text{constant} = n^3 / [n+1]^5$$

$$\text{for roots } n_{\Lambda \text{min}} = 0.23890175... \text{ and } n_{\Lambda \text{max}} = 11.97186...$$

$$\{G_0 M_0 / 2c^2 R_H\} = \text{constant} = [n]^2 / [n+1]^5$$

$$\text{for } \Lambda_0\text{-DE roots: } n_{+/-} = 0.1082331... \text{ and } n_{-/ +} = 3.40055...$$

$$\text{for asymptote } \Lambda_{0\infty} = G_0 M_0 / R_H^2 = 7.894940128... \times 10^{-12} \text{ (m/s}^2\text{)*}$$

$$\text{For } k=1; \{G_0 M_0 / 3n_1^3 c^2 R_H\} = \text{constant} = [n-1]^3 / [n-1+n_1]^5 = [n-1]^3 / [n+233.472]^5$$

$$\text{for roots } n_{\Lambda \text{min}} = 7.66028... \text{ and } n_{\Lambda \text{max}} = 51,941.9..$$

$$\{G_0 M_0 / 2n_1^4 c^2 R_H\} = \text{constant} = [n-1]^2 / [n-1+n_1]^5 = [n-1]^2 / [n+233.472]^5$$

$$\text{for } \Lambda_1\text{-DE roots: } n_{+/-} = 2.29966... \text{ and } n_{-/ +} = 7,161.518...$$

$$\text{for asymptote } \Lambda_{1\infty} = G_0 M_0 / n_1^2 R_H^2 = 1.43604108... \times 10^{-16} \text{ (m/s}^2\text{)*}$$

$$\text{For } k=2; \{G_0 M_0 / 3n_1^3 n_2^3 c^2 R_H\} = \text{constant} = [n-1-n_1]^3 / [n-1-n_1+n_1 n_2]^5$$

$$= [n-235.472]^3 / [n+57,400.794]^5$$

$$\text{for roots } n_{\Lambda \text{min}} = 486.7205 \text{ and } n_{\Lambda \text{max}} = 2.0230105 \times 10^8$$

$$\{G_0 M_0 / 2n_1^4 n_2^4 c^2 R_H\} = \text{constant} = [n-1-n_1]^2 / [n-1-n_1+n_1 n_2]^5 = [n-235.472]^2 / [n+57,400.794]^5$$

$$\text{for } \Lambda_2\text{-DE roots: } n_{+/-} = 255.5865... \text{ and } n_{-/ +} = 1.15382943... \times 10^7 \text{ for asymptote}$$

$$\Lambda_{2\infty} = G_0 M_0 / n_1^2 n_2^2 R_H^2 = 2.37660590... \times 10^{-21} \text{ (m/s}^2\text{)}^*$$

$$\text{For } k=3; \{G_0 M_0 / 3n_1^3 n_2^3 n_3^3 c^2 R_H\} = \text{constant} = [n-1-n_1-n_1 n_2]^3 / [n-1-n_1-n_1 n_2+n_1 n_2 n_3]^5$$

$$= [n-57,871.74]^3 / [n+1.47691729 \times 10^7]^5$$

$$\text{for roots } n_{\Lambda \text{min}} = 67,972.496 \text{ and } n_{\Lambda \text{max}} = 8.3526797... \times 10^{11}$$

$$\{G_0 M_0 / 2n_1^4 n_2^4 n_3^4 c^2 R_H\} = \text{constant} = [n-1-n_1-n_1 n_2]^2 / [n-1-n_1-n_1 n_2+n_1 n_2 n_3]^5$$

$$= [n-57,871.74]^2 / [n+1.47691729 \times 10^7]^5$$

$$\text{for } \Lambda_3\text{-DE roots: } n_{+/-} = 58,194.1... \text{ and } n_{-/ +} = 1.9010262... \times 10^{10} \text{ for asymptote}$$

$$\Lambda_{3\infty} = G_0 M_0 / n_1^2 n_2^2 n_3^2 R_H^2 = 3.59120049... \times 10^{-26} \text{ (m/s}^2\text{)}^*$$

and where

$$\Pi n_k = 1 = n_0 \text{ and } \Pi n_{k-1} = 0 \text{ for } k=0$$

with Instanton/Inflaton resetting for initial boundary parameters

$$\Lambda_0 / a_{\text{deBroglie}} = \{G_0 M_0 / R_k(n)^2\} / \Pi n_k R_H f_{ps}^2$$

$$= \{G_0 M_0 (n - \sum \Pi n_{k-1} + \Pi n_k)^2\} / \{\Pi n_k\}^2 \cdot R_H^2 (n - \sum \Pi n_{k-1})^2 (\Pi n_k R_H f_{ps}^2)\} = (\Pi n_k) \frac{1}{2} \Omega_0$$

for Instanton-Inflaton Baryon Seed Constant  $\Omega_0 = M_0^* / M_H^* = 0.02803$

for the kth universal matter evolution

$$k=0 \text{ for Reset } n = n_{ps} = H_0 t \text{ and } \Lambda_0 / a_{\text{deBroglie}} = G_0 M_0 (n_{ps} + 1)^2 / \{R_H^3 n_{ps}^2 (f_{ps}^2)\}$$

$$= G_0 M_0 / R_H c^2 = M_0 / 2M_H = \frac{1}{2} \Omega_0$$

$$k=1 \text{ for Reset } n = 1 + n_{ps} \text{ and } \Lambda_0 / a_{\text{deBroglie}} = G_0 M_0 (1 + n_{ps} - 1 + n_1)^2 / \{[n_1]^2 \cdot R_H^3 (1 + n_{ps} - 1)^2 (n_1 f_{ps}^2)\}$$

$$= M_0 / 2n_1 M_H = M_0 / 2M_H^* = \frac{1}{2} \Omega_0^*$$

$$k=2 \text{ for Reset } n = n_1 + 1 + n_{ps} \text{ and } \Lambda_0 / a_{\text{deBroglie}}$$

$$= G_0 M_0 (n_1 + 1 + n_{ps} - 1 - n_1 + n_1 n_2)^2 / \{[n_1 n_2]^2 \cdot R_H^3 (n_1 + 1 + n_{ps} - 1 - n_1)^2 (n_1 n_2 f_{ps}^2)\} = \frac{1}{2} \Omega_0^{**}$$

$$k=3 \text{ for Reset } n = n_1 n_2 + n_1 + 1 + n_{ps} \text{ and } \Lambda_0 / a_{\text{deBroglie}}$$

$$= G_0 M_0 (n_1 n_2 + n_1 + 1 + n_{ps} - 1 - n_1 - n_1 n_2 + n_1 n_2 n_3)^2 / \{[n_1 n_2 n_3]^2 \cdot R_H^3 (n_1 n_2 + n_1 + 1 + n_{ps} - 1 - n_1 - n_1 n_2)^2 (n_1 n_2 n_3 f_{ps}^2)\} = \frac{1}{2} \Omega_0^{***}$$

$$\dots \text{with } n_{ps} = 2\pi \Pi n_{k-1} \cdot X^n_k = \lambda_{ps} / R_H = H_0 t_{ps} = H_0 / f_{ps} = ct_{ps} / R_H \text{ and } R_H = 2G_0 M_H / c^2$$

$$N_0 = H_0 t_0 / n_0 = H_0 t = n$$

$$N_1 = H_0 t_1 / n_1 = (n-1) / n_1$$

$$N_2 = H_0 t_2 / n_1 n_2 = (n-1-n_1) / n_1 n_2$$

$$N_3 = H_0 t_3 / n_1 n_2 n_3 = (n-1-n_1-n_1 n_2) / n_1 n_2 n_3$$

....

$$dn/dt = H_0$$

.....

$$N_k = H_0 t_k / \Pi n_k = (n - \sum \Pi n_{k-1}) / \Pi n_k$$

$$t_k = t - (1/H_0) \sum \Pi n_{k-1} \text{ for } n_0 = 1 \text{ and } N_0 = n$$

$$t_0 = t = n / H_0 = N_0 / H_0 = n R_H / c$$

$$t_1 = t - 1 / H_0 = (n-1) / H_0 = [n_1 N_1] / H_0$$

$$t_2 = t - (1+n_1) / H_0 = (n-1-n_1) / H_0 = (n_1 n_2 N_2) / H_0$$

$$t_3 = t - (1+n_1+n_1 n_2) / H_0 = (n-1-n_1-n_1 n_2) / H_0 = (n_1 n_2 n_3 N_3) / H_0$$

.....

$$\begin{aligned}
R(n) &= R(N_0) = n_0 R_H \{n/[n+1]\} = R_H \{n/[n+1]\} \\
R_1(N_1) &= n_1 R_H \{N_1/[N_1+1]\} = n_1 R_H \{(n-1)/[n-1+n_1]\} \\
R_2(N_2) &= n_1 n_2 R_H \{N_2/[N_2+1]\} = n_1 n_2 R_H \{(n-1-n_1)/[n-1-n_1+n_1 n_2]\} \\
R_3(N_3) &= n_1 n_2 n_3 R_H \{N_3/[N_3+1]\} = n_1 n_2 n_3 R_H \{(n-1-n_1-n_1 n_2)/[n-1-n_1-n_1 n_2+n_1 n_2 n_3]\} \\
&\dots\dots \\
\mathbf{R_k(n)} &= \mathbf{\Pi n_k R_H (n - \Sigma \Pi n_{k-1}) / \{n - \Sigma \Pi n_{k-1} + \Pi n_k\}}
\end{aligned}$$

$$\dots = R_H(n/[n+1]) = n_1 R_H(N_1/[N_1+1]) = n_1 n_2 R_H(N_2/[N_2+1]) = \dots$$

$$\mathbf{V_k(n)} = \mathbf{dR_k(n)/dt} = \mathbf{c \{ \Pi n_k \}^2 / \{ n - \Sigma \Pi n_{k-1} + \Pi n_k \}^2}$$

$$\begin{aligned}
\dots &= c/[n+1]^2 = c/[N_1+1]^2 = c/[N_2+1]^2 = \dots \\
\dots &= c/[n+1]^2 = c(n_1)^2/[n-1+n_1]^2 = c(n_1 n_2)^2/[n-1-n_1+n_1^2 n_2^2]^2 = \dots
\end{aligned}$$

$$\mathbf{A_k(n)} = \mathbf{d^2 R_k(n)/dt^2} = \mathbf{-2cH_0(\Pi n_k)^2 / (n - \Sigma \Pi n_{k-1} + \Pi n_k)^3}$$

$$\begin{aligned}
\dots &= -2cH_0/(n+1)^3 = -2cH_0/n_1(N_1+1)^3 = -2cH_0/n_1 n_2(N_2+1)^3 = \dots \\
\dots &= -2cH_0/[n+1]^3 = -2cH_0\{n_1\}^2/[n-1+n_1]^3 = -2cH_0(n_1 n_2)^2/[n-1-n_1+n_1 n_2]^3 = \dots
\end{aligned}$$

$G_0 M_0$  is the Gravitational Parameter for the Baryon mass seed; Curvature Radius  $R_H = c/H_0$  in the nodal Hubble parameter  $H_0$  and  $c$  is the speed of light

### Hubble Parameters:

$$\begin{aligned}
H(n)|_{dS} &= \{V_k(n)\}/\{R_k(n)\} = \{c \{ \Pi n_k \}^2 / [n - \Sigma \Pi n_{k-1} + \Pi n_k]^2\} / \{\Pi n_k R_H [n - \Sigma \Pi n_{k-1}] / (n - \Sigma \Pi n_{k-1} + \Pi n_k)\} \\
&= \Pi n_k H_0 / \{ [n - \Sigma \Pi n_{k-1}] [n - \Sigma \Pi n_{k-1} + \Pi n_k] \}
\end{aligned}$$

$$\begin{aligned}
\mathbf{H(n)}|_{dS} &= \mathbf{H_0 / \{ [n] [n+1] \}} = \mathbf{H_0 / T(n)} = n_1 H_0 / \{ [n-1] [n-1+n_1] \} = n_1 n_2 H_0 / \{ [n-1-n_1] [n-1-n_1+n_1 n_2] \} = \dots \text{ for } dS \\
H(n)^*|_{dS} &= H_0 / [n - \Sigma \Pi n_{k-1}] \text{ for oscillating } H^*(n) \text{ parameter for compacted recession velocity wavefront} \\
&\text{between nodes } k \text{ and } k+1 \quad | \quad | n_{ps} + \Sigma \Pi n_{k-1} - \Sigma \Pi n_k | \quad |
\end{aligned}$$

$$= H_0 / (2 - n_{\text{present}}) = H_0 / 0.86729 = 1.15302 H_0 \text{ for } n_{\text{present}} = 1.1327127\dots$$

with dark matter sector

$$= H_0 / \{ n_p / [1 + n_p] \} \{ (n_p / [1 + n_p] + 1) \} = H_0 [1 + n_p]^2 / \{ n_p [2n_p + 1] \} = H_0 / 0.8132 = 1.22972 H_0 \text{ for } n_{\text{present}} = 1.1327127\dots$$

without dark matter sector

$$H(n)|_{AdS} = \{V_k(n)\}/\{R_k(n)\} = c/\{R_H(n - \Sigma \Pi n_{k-1})\}$$

$$H(n)|_{AdS} = H_0 / (n - \Sigma \Pi n_{k-1})$$

$$\mathbf{H(n)}|_{AdS} = \mathbf{H_0/n} = H_0 / (n-1) = H_0 / (n-1-n_1) = \dots \text{ for AdS}$$

$$\mathbf{dH/dt}|_{dS} = \mathbf{(dH/dn)(dn/dt)} = \mathbf{d\{H_0/T(n)\}/dn} H_0 = \mathbf{-H_0^2 \{2n+1\} / \{T(n)\}^2}$$

$$= -\Pi n_k H_0^2 \{2n - 2\Sigma \Pi n_{k-1} + \Pi n_k\} / \{n^2 - 2n\Sigma \Pi n_{k-1} + (\Sigma \Pi n_{k-1})^2 + \Pi n_k [n - \Sigma \Pi n_k]\}^2$$

$$= -\Pi n_k H_0^2 \{ [2n - \Sigma \Pi n_{k-1} + \Pi n_k] / \{ (n - \Sigma \Pi n_{k-1}) (n - \Sigma \Pi n_{k-1} + \Pi n_k) \} \}^2$$

$$= -H_0^2 \{2n+1\} / \{n^2+n\}^2 = -n_1 H_0^2 \{2n-1+n_1\} / \{ [n-1] [n-1+n_1] \}^2$$

$$= -n_1 n_2 H_0^2 \{2n-n_1+n_1 n_2\} / \{ [n-1-n_1] [n-1-n_1+n_1 n_2] \}^2 = \dots$$

$$dH/dt|_{AdS} = (dH/dn)(dn/dt) = -H_0 c / \{ (R_H (n - \Sigma \Pi n_{k-1}))^2 \} = -H_0^2 / \{ (n - \Sigma \Pi n_{k-1})^2 \} \text{ for AdS and recession velocity}$$

$$dH/dt|_{AdS} = -H_0^2 / \{ (n - \Sigma \Pi n_{k-1})^2 \} \dots = -H_0^2 / n^2 = H_0^2 / (n-1)^2 = -H_0^2 / (n-1-n_1)^2 = \dots$$

$$dH/dt + 4\pi G_0 \rho = -4\pi G_0 P/c^2 \text{ for spherical volume } 4\pi R^3/3$$

$$dH/dt + 6\pi^2 G_0 \rho = -6\pi^2 G_0 P/c^2 \text{ for horn torus volume } 2\pi^2 R^3$$

$$dH/dt + 4\pi G_0 M_0/R(n)^3 = 4\pi \Lambda(n)/R(n) + 8\pi n H_0^2/T(n)^2 - H_0^2(2n+1)/T(n)^2 = -4\pi G_0 P/c^2$$

$$P(n,t) = -\Lambda(n,t)c^2/G_0 R(n)^3 - \{H_0^2 c^2/4\pi G_0 T(n)^2\} \{2n[4\pi-1]-1\} = (2n+1)H_0^2 c^2/4\pi G_0 T(n)^2 - M_0 c^2/R(n)^3 \text{ for dS with}$$

$$G_0 \rho = G_0 M_0/R(n)^3 = -G_0 P/c^2 - (dH/dt)/4\pi = \Lambda(n)/R(n) + 2cH_0/R(n)[n+1]^3 \text{ for Volume } V_{dS} = 4\pi R(n)^3/3$$

$$\Lambda_k(n)/R_k(n) = G_0 M_0 / \{R_H(n-\Sigma \Pi n_{k-1})\}^3 - H_0^2 / \{2(n-\Sigma \Pi n_{k-1})\} / \{(n-\Sigma \Pi n_{k-1})(n-\Sigma \Pi n_{k-1} + \Pi n_k)\}^2$$

$$P(n=H_0 t) = c^2 H_0^2 (2n+1) / \{4\pi G_0 / T(n)^2\} - M_0 c^2 / R(n)^3 \dots\dots\dots$$

$$= c^2 H_0^2 \{2(n-\Sigma \Pi n_{k-1})+1\} / \{4\pi G_0 / \{(n-\Sigma \Pi n_{k-1})(n-\Sigma \Pi n_{k-1} + \Pi n_k)\}^2\} - M_0 c^2 (n-\Sigma \Pi n_{k-1} + \Pi n_k)^3 / \{(n-\Sigma \Pi n_{k-1})R_H\}^3$$

**Deceleration Parameters:**

$$q_{Ads}(n) = -A_k(n)R_k(n)/V_k(n)^2$$

$$= -\{(-2cH_0[\Pi n_k]^2)/(n-\Sigma \Pi n_{k-1} + \Pi n_k)^3\} \{\Pi n_k R_H(n-\Sigma \Pi n_{k-1})/(n-\Sigma \Pi n_{k-1} + \Pi n_k)\} / \{[\Pi n_k]^2 c / (n-\Sigma \Pi n_{k-1} + \Pi n_k)\}^2$$

$$q_{Ads}(n) = 2n \dots = 2(n-\Sigma \Pi n_{k-1})/\Pi n_k$$

$$q_{dS}(n) = q_{AdS+dS}(n) = 2(n-\Sigma \Pi n_{k-1})/\Pi n_k$$

$$q_{dS}(n) = 1/q_{AdS+dS}(n) - 1 = 1/2n - 1 \dots = \Pi n_k / \{2[n-\Sigma \Pi n_{k-1}] - 1\}$$

Scale factor modulation at  $N_k = \{n-\Sigma \Pi n_{k-1}\}/\Pi n_k = 1/2$  reset coordinate

$$\dots = 2n = 2(n-1)/n_1 = 2(n-1-n_1)/(n_1 n_2) = 2(n-1-n_1-n_1 n_2)/(n_1 n_2 n_3) = \dots \text{ for AdS}$$

$$\dots = 1/\{2n\} - 1 = n_1/\{2[n-1]\} - 1 = n_1 n_2 / \{2(n-1-n_1)\} - 1 = n_1 n_2 n_3 / \{2(n-1-n_1-n_1 n_2)\} - 1 = \dots \text{ for dS}$$

Dark Energy Initiation for  $q_{dS}=0$  with  $q_{AdS}=1$

$$k=0 \text{ for } n = 1/2 = 0.50000 \text{ for } q_{dS}=0 \text{ with } q_{AdS}=1$$

$$k=1 \text{ for } n = 1/2 n_1 + 1 = 118.236\dots \text{ for } q_{dS}=0 \text{ with } q_{AdS}=1$$

$$k=2 \text{ for } n = 1/2 n_1 n_2 + n_1 + 1 = 29,053.605\dots \text{ for } q_{dS}=0 \text{ with } q_{AdS}=1$$

$$k=3 \text{ for } n = 1/2 n_1 n_2 n_3 + n_1 n_2 + n_1 + 1 = 7,471,394.054\dots \text{ for } q_{dS}=0 \text{ with } q_{AdS}=1$$

**Temperature:**

$$T(n) = \sqrt[4]{\{M_0 c^2 / (1100 \sigma \pi^2 \cdot R_k(n)^2 \cdot t_k)\}} \text{ and for } t_k = (n-\Sigma \Pi n_{k-1})/H_0$$

$$T_k(n) = \sqrt[4]{\{H_0 M_0 c^2 (n-\Sigma \Pi n_{k-1} + \Pi n_k)^2 / [1100 \sigma \pi^2 \cdot R_H^2 \cdot (n-\Sigma \Pi n_{k-1})^3]\}}$$

$$= \sqrt[4]{\{(H_0^3 M_0 (n-\Sigma \Pi n_{k-1} + \Pi n_k)^2) / [1100 \sigma \pi^2 (n-\Sigma \Pi n_{k-1})^3]\}} = \sqrt[4]{\{18.199 (n-\Sigma \Pi n_{k-1} + \Pi n_k)^2 / (n-\Sigma \Pi n_{k-1})^3\}}$$

$$T(n) = \sqrt[4]{\{18.2[n+1]^2/n^3\}} = \sqrt[4]{\{18.2[n-1+n_1]^2/(n-1)^3\}} = \sqrt[4]{\{18.2[n-1-n_1+n_1 n_2]^2/(n-1-n_1)^3\}} = \dots$$

**Comoving Redshift:**

$$z + 1 = \sqrt{\{(1+v/c)/(1-v/c)\}} = \sqrt{\{([n-\Sigma\Pi n_{k-1}+\Pi n_k]^2+[\Pi n_k]^2)/([n-\Sigma\Pi n_{k-1}+\Pi n_k]^2-[\Pi n_k]^2)\}}$$

$$= \sqrt{\{([n-\Sigma\Pi n_{k-1}]^2+2\Pi n_k(n-\Sigma\Pi n_{k-1})+2([\Pi n_k]^2)/([n-\Sigma\Pi n_{k-1}]^2+2\Pi n_k(n-\Sigma\Pi n_{k-1}))\}}$$

$$= \sqrt{\{1 + 2([\Pi n_k]^2)/\{(n-\Sigma\Pi n_{k-1})(n-\Sigma\Pi n_{k-1}+2\Pi n_k)\}\}}$$

$$z+1 = \sqrt{\{1 + 2/[\{(n^2-2n\Sigma\Pi n_{k-1}+(\Sigma\Pi n_{k-1})^2+2n-2\Sigma\Pi n_{k-1}\}}\}} = \sqrt{\{1+2/\{n(n+2-2\Sigma\Pi n_{k-1}) + \Sigma\Pi n_{k-1}(\Sigma\Pi n_{k-1}-2)\}\}}$$

$$z+1 = \sqrt{\{1+2/(n[n+2])\}} = \sqrt{\{1+2/[(n-1)[n-1+2n_1])\}} = \sqrt{\{1+2/[(n-1-n_1)[n-1-n_1+2n_1n_2])\}} = \dots$$

**Baryon-Dark Matter Saturation:**

$\Omega_{DM} = 1-\Omega_{BM}$  until Saturation for BM-DM and Dark Energy Separation

$$\rho_{BM+DM}/\rho_{critical} = M_o R_H^3/M_H R(n)^3 = \Omega_o Y^n(1+1/n)^3 = \Omega_o Y^{\{(n-\Sigma\Pi n_{k-1})/n_k\}}/\{(n-\Sigma\Pi n_{k-1})/(n-\Sigma\Pi n_{k-1}+\Pi n_k)\}^3$$

$$= M_o Y^{\{(n-\Sigma\Pi n_{k-1})/n_k\}}/\{\rho_{critical} R_k(n)^3\}$$

**Baryon Matter Fraction:**  $\Omega_{BM} = \Omega_o Y^n = \dots \Omega_o Y^{(N_k)} = \Omega_o \cdot Y^{\{(n-\Sigma\Pi n_{k-1})/n_k\}}$

**Dark Matter Fraction:**  $\Omega_{DM} = \Omega_o Y^n\{(1+1/n)^3 - 1\} = \Omega_{BM}\{(1+1/n)^3 - 1\}$

$$\Omega_o Y^{\{(n-\Sigma\Pi n_{k-1})/n_k\}}\{1-\{(n-\Sigma\Pi n_{k-1})/(n-\Sigma\Pi n_{k-1}+\Pi n_k)\}^3\}/\{(n-\Sigma\Pi n_{k-1})/(n-\Sigma\Pi n_{k-1}+\Pi n_k)\}^3$$

$$= \Omega_o Y^{\{(n-\Sigma\Pi n_{k-1})/n_k\}}\{(n-\Sigma\Pi n_{k-1}+\Pi n_k)^3-(n-\Sigma\Pi n_{k-1})^3\}/\{(n-\Sigma\Pi n_{k-1})^3\}$$

$$= \Omega_o Y^{\{(n-\Sigma\Pi n_{k-1})/n_k\}}\{(1+\Pi n_k/[n-\Sigma\Pi n_{k-1}])^3 - 1\} = \Omega_{BM}\{(1+\Pi n_k/[n-\Sigma\Pi n_{k-1}])^3 - 1\}$$

**Dark Energy Fraction:**  $\Omega_{DE} = 1 - \Omega_{DM} - \Omega_{BM} = 1 - \Omega_{BM}\{(1+\Pi n_k/[n-\Sigma\Pi n_{k-1}])^3\}$

$\Omega_{BM}=\text{constant}=0.0553575$  from Saturation to Intersection with Dark Energy Fraction

$$\Omega_o Y^{\{(n-\Sigma\Pi n_{k-1})/n_k\}} = \rho_{BM+DM} R_k(n)^3/M_H = [N_k]^3/[N_k+1]^3 = \{(n-\Sigma\Pi n_{k-1})/(n-\Sigma\Pi n_{k-1}+\Pi n_k)\}^3$$

$$= R_k(n)^3/V_H = V_{ds}/V_{Ads}$$

for  $\rho_{BM+DM} = M_H/R_H^3 = \rho_{critical}$  and for Saturation at  $N_i = 6.541188\dots = \text{constant} \forall N_i$

$(M_o/M_H) \cdot Y^{\{(n-\Sigma\Pi n_{k-1})/n_k\}} = \{(n-\Sigma\Pi n_{k-1})/(n-\Sigma\Pi n_{k-1}+\Pi n_k)\}^3$  with a Solution for  $f(n)$  in Newton-Raphson Root Iteration and first Approximation  $x_0$

$$x_{k+1} = x_k - f(n)/f'(n) = x_k - \{(M_o/M_H) \cdot Y^{\{(n-\Sigma\Pi n_{k-1})/n_k\}} - (n-\Sigma\Pi n_{k-1})/(n-\Sigma\Pi n_{k-1}+\Pi n_k)^3\} / \{(M_o/M_H) \cdot [\ln Y] Y^{\{(n-\Sigma\Pi n_{k-1})/n_k\}} - 3(n-\Sigma\Pi n_{k-1})^2/(n-\Sigma\Pi n_{k-1}+\Pi n_k)^4\}$$

$$x_1 = x_0 - \{(M_o/M_H) \cdot Y^{[n]} - (n/n+1)^3\} / \{(M_o/M_H) \cdot [\ln Y] Y^{[n]} - 3n^2/[n+1]^4\}$$

$$= x_0 - \{(M_o/M_H) \cdot Y^{(N_0)} - (N_0)^3/(N_0+1)^3\} / \{(M_o/M_H) \cdot [\ln Y] Y^{(N_0)} - 3(N_0)^2/1(N_0+1)^4\}$$

$$x_1 = x_0 - \{(M_o/M_H) \cdot Y^{\{(n-1)/n_1\}} - (n-1)^3/(n-1+n_1)^3\} / \{(M_o/M_H) \cdot [\ln Y] Y^{\{(n-1)/n_1\}} - 3(n-1)^2/(n-1+n_1)^4\}$$

$$= x_0 - \{(M_o/M_H) \cdot Y^{(N_1)} - (N_1)^3/(N_1+1)^3\} / \{(M_o/M_H) \cdot [\ln Y] Y^{(N_1)} - 3(N_1)^2/n_1(N_1+1)^4\}$$

$$x_1 = x_0 - \{(M_o/M_H) \cdot Y^{\{(n-1-n_1)/n_1n_2\}} - (n-1-n_1)^3/(n-1-n_1+n_1n_2)^3\} / \{(M_o/M_H) \cdot [\ln Y] Y^{\{(n-1-n_1)/n_1n_2\}} - 3(n-1-n_1)^2/(n-1-n_1+n_1n_2)^4\}$$

$$= x_0 - \{(M_o/M_H) \cdot Y^{(N_2)} - (N_2)^3/(N_2+1)^3\} / \{(M_o/M_H) \cdot [\ln Y] Y^{(N_2)} - 3(N_1)^2/n_1n_2(N_2+1)^4\}$$

.....



$$n = 1. N_0 = N_i = 6.541188... \Rightarrow N_i \forall i \text{ for } \prod n_k = n_0 = 1$$

$$n = n_1 N_1 + 1 = (234.472)(6.541188...) + 1 = 1534.725... \text{ for } \prod n_k = n_0 n_1 = n_1$$

$$n = n_1 n_2 N_2 + 1 + n_1 = (234.472 \times 245.813)(6.541172) + 1 + 234.472 = 377,244.12 \text{ for } \prod n_k = n_0 n_1 n_2 = n_1 n_2$$

$$n = n_1 n_2 n_3 N_3 + 1 + n_1 + n_1 n_2 = (234.472 \times 245.813 \times 257.252)(6.541172) + 1 + 234.472 + (234.472 \times 245.813) = 97,044,120.93... \text{ for } \prod n_k = n_0 n_1 n_2 n_3 = n_1 n_2 n_3 \dots$$

**Baryon-Dark Matter Intersection:**

$$N_k = \sqrt{2} \text{ for } n = \sqrt{2} \cdot \prod n_k + \sum \prod n_{k-1}$$

$$n_0 = 1 \cdot \sqrt{2} + 0 = n_0$$

$$n_1 = n_1 \sqrt{2} + 1 = 332.593 = n_1 \sqrt{2} + 1$$

$$n_2 = n_1 n_2 \sqrt{2} + 1 + n_1 = 81,745.461 n_3 = n_1 n_2 n_3 \sqrt{2} + 1 + n_1 + n_1 n_2 = 21,026,479.35...$$

**The Universal Baryon Seeding within the Multiverse within the Omniverse**

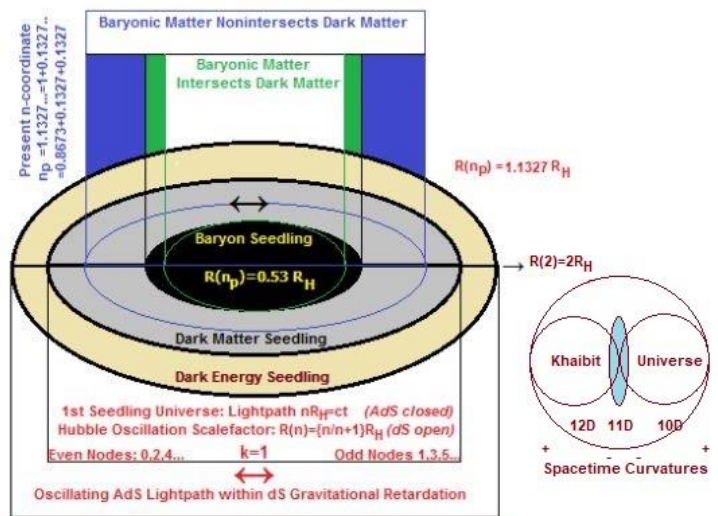
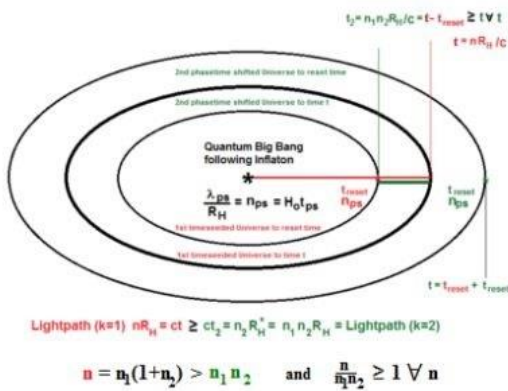

$$\frac{n}{\prod n_k} = 1 + \frac{1}{n_{k+1}} + \left\{ \frac{1}{n_k} + \frac{1}{n_k n_{k-1}} + \frac{1}{n_k n_{k-1} n_{k-2}} + \dots + \frac{1}{n_k \dots n_2} \right\}$$

$$\frac{t}{t_k} = 1 + \frac{1}{t_k} \sum_{n=1}^{k-1} t_n = 1 + \frac{1}{t_k} \{ t_1 + t_2 + t_3 + \dots + t_{k-1} \}$$

**Volume of Omniverse as Summation of all  $n_k$ -cycle defined Universes at time  $t$**   
**Volume of the nested Multiverse at a particular time  $t_k = 7.428.. / H_{ok}$  in cycle  $k$**

To mirror a micro quantum cosmic evolution  $n_{ps} / 2\pi \cdot Y$   $n=234.472..$   
 in its macro quantum Black Hole image  $M_{co} / M_o = \Omega_o = R_H / R_S = Y$   $n=7.428..$   $(n=n_1)$   
 $(n=n_k)$

Vafa (Father) White Hole of Radius  $R(n) = 2R_H$   $n=2$   
 Witten (Mother) Black Hole of Radius  $R(n) = 1R_H$   $n=1$   
 Baryon (Child) Black Hole of Radius  $R(n) = 1/2 R_H$   $n=1$

$$\Lambda_E = \frac{G_o M_o}{(1/2 R_H)^2} - \frac{2cH_o}{(n+1)^3} = 0 \text{ for } n=2.292.. \left[ \text{projected } \Lambda_{DE} \text{ Min at } n=2.29966! \right]$$

$$\Omega_o = 0.02803 = 1/(n+1)^3 \text{ for } M_o / M_H = 2\Lambda_o / \Lambda_{dB} = (2G_o M_o / \lambda_{ps})^2 / (R_H / \lambda_{ps})^2 = R_g R_H$$

$\{R(n) \rightarrow 1/2 R_H\}$  to synchronize 11D-WH with 11D-BH

Hypermass Evolution:

$$Y_k^{\{(n-\Sigma \pi_{k-1})/\pi_{n_k}\}} = 2\pi n_k R_H / \lambda_{ps} = \pi n_k R_H / r_{ps} = \pi n_k M_H^{*k} / m_H^{*k} \text{ for } M_H = c^2 R_H / 2G_o \text{ and } m_H = c^2 r_{ps} / 2G_o$$

**Hypermass  $M_{Hyper} = m_H \cdot Y_k^{\{(n-\Sigma \pi_{k-1})/\pi_{n_k}\}}$**

..... =  $Y^n = Y^{([n-1]/n_1)} = Y^{([n-1-n_1]/n_1 n_2)} = \dots$

k=0 for  $M_{Hyper} = M_H = 1 \cdot M_H = m_H \cdot Y^{(n)}$  with  $n = 1 \cdot \{\ln(2\pi/n_{ps})/\ln Y\} = n_1 = 234.472$

k=1 for  $M_{Hyper} = n_1 \cdot M_H = M_H^* = m_H \cdot Y^{\{(n-1)/n_1\}}$  with  $n = [1] + n_1 \cdot \{\ln(2\pi n_1/n_{ps})/\ln Y\} = [1] + n_1 n_2$   
 $= 1 + 234.472 \times 245.812 = 57,637.03$

k=2 for  $M_{Hyper} = n_1 n_2 \cdot M_H = M_H^{**} = m_H \cdot Y^{\{(n-1-n_1)/n_1 n_2\}}$  with  $n = [1 + n_1] + n_1 n_2 \cdot \{\ln(2\pi n_1 n_2/n_{ps})/\ln Y\} =$   
 $[1 + n_1] + n_1 n_2 n_3$   
 $= 235.472 + 234.472 \times 245.812 \times 257.251 = 14,827,185.4$

k=3 for  $M_{Hyper} = n_1 n_2 n_3 \cdot M_H = M_H^{***} = m_H \cdot Y^{\{(n-1-n_1-n_1 n_2)/n_1 n_2 n_3\}}$  with  $n =$  with  $n = [1 + n_1 + n_1 n_2] +$   
 $n_1 n_2 n_3 \cdot \{\ln(2\pi n_1 n_2 n_3/n_{ps})/\ln Y\} = [1 + n_1 + n_1 n_2] + n_1 n_2 n_3 n_4$   
 $= 57,871.74 + 234.472 \times 245.812 \times 257.251 \times 268.785 = 3,985,817,947.8$



## IX: Ylemic Gluon-Quark-Plasma Protostars as Vortex QBBS Energies

The stability of stars is a function of the equilibrium condition, which balances the inward pull of gravity with the outward pressure of the thermodynamic energy or enthalpy of the star ( $H=PV+U$ ).

The Jeans Mass  $M_J$  and the Jeans Length  $R_J$  used to describe the stability conditions for collapsing molecular hydrogen clouds to form stars, are well known in the scientific data base, say in formulations such as:

$$M_J=3k_B TR/2Gm \text{ for a Jeans Length of } R_J=\sqrt{\{15k_B T/(4\pi\rho Gm)\}}=R_J =\sqrt{(k_B T/Gnm^2)}.$$

Now the Ideal Gas Law of basic thermodynamics states that the internal pressure  $P$  and Volume of such an ideal gas are given by  $PV=nRT=Nk_B T$  for  $n$  moles of substance being the Number  $N$  of molecules (say) divided by Avogadro's Constant  $L$  in  $n=N/L$ .

Since the Ideal Gas Constant  $R$  divided by Avogadro's Constant  $L$  defines Boltzmann's Constant  $k=R/L$ . The statistical analysis of kinetic energy  $KE$  of particles in motion in a gas (say) gives a root-mean-square velocity (rms) and the familiar  $2.KE=mv^2(\text{rms})$  from the distribution of individual velocities  $v$  in such a system.

It is found that  $PV=(2/3)N.KE$  as a total system described by the  $v(\text{rms})$ . Setting the  $KE$  equal to the Gravitational  $PE=GMm/R$  for a spherical gas cloud gives the Jeans Mass  $(3/2N).(Nk_B T)=GMm/R$  with  $m$  the mass of a nucleon or Hydrogen atom and  $M=M_J=3k_B TR/2Gm$  as stated.

The Jeans' Length is the critical radius of a cloud (typically a cloud of interstellar dust) where thermal energy, which causes the cloud to expand, is counter acted by gravity, which causes the cloud to collapse. It is named after the British astronomer Sir James Jeans, who first derived the quantity; where  $k_B$  is Boltzmann Constant,  $T$  is the temperature of the cloud,  $R$  is the radius of the cloud,  $m$  is the mass per particle in the cloud,  $G$  is the Gravitational Constant and  $\rho$  is the cloud's mass density (i.e., the cloud's mass divided by the cloud's volume).

Shortly after the Big Bang, there were of course no gas clouds in the early expanding universe and the Jeans formulations are not applicable to the mass seedling  $M_o$ ; in the manner of the Jeans formulations as given. However, the universe's dynamics is in the form of the expansion parameter of General Relativity and so as  $R(n)=R_{\text{max}}(n/(n+1))$  with the scale factor of Quantum Relativity.

Expressing the Jeans radius in the form of the Hawking radius of primordial micro black holes with a fixed nuclear density defined by subatomic parameters of the timespace made manifest in the QBBS, then allows analysis of the thermodynamic universe expansion as a function of temperature, independent on the distribution of the mass seedling  $M_o$ . as the Gamow-Hawking protostars matching the universal temperature background as potential vortex energies given by the Hawking masses.

The thermal internal energy or  $ITE=H$  is the outward pressure in equilibrium with the gravitational potential energy of  $GPE=\Omega$ . The nuclear density in terms of the super brane parameters is  $\rho_{\text{critical}}=m_c/V_{\text{critical}}$  with  $m_c$  a base-nucleon mass for an 'ylemic neutron'.

$V_{\text{critical}} = 4\pi R_e^3/3$  or the volume for the ylemic neutron as given by the classical electron radius  
 $R_e = 10^{10} \lambda_{\text{ps}}/360 = \{e^*/2c^2\}_{\text{mod}}$   
 $H = (\text{molarity})k_B T$  for molar volume as  $N = (R/R_e)^3$  for  $dH = 3k_B TR^2/R_e^3$

The gravitational potential energy is  $\Omega(R) = -\int G_o M dm/R$   
 $= -4\pi\rho G_o \int \{4\pi\rho R^3/3\} \{R^2/R\} dR$   
 $= -\{16\pi^2\rho^2 G_o/3\} \int R^4 dR = -\{16\pi^2\rho^2 G_o/15\} \{R^5\}$   
 $d\Omega/dR = -\{16\pi^2\rho^2 G_o/3\} \{R^4\} = -3G_o m_c^2 R^4$  for  $dM/dR = d(\rho V)/dR = 4\pi\rho R^2$  and for  $\rho = M/V = 3m_c/4\pi R_e^3$

For equilibrium, the requirement is that  $dH = d\Omega$  in the minimum condition  $dH + d\Omega = 0$ .

This gives  $dH + d\Omega = 3k_B TR^2/R_e^3 - 3G_o m_c^2 R^4 = 0$  and the ylemic radius as:

**$R_{\text{ylem}} = \sqrt{\{k_B TR_e/G_o m_c^2\}} \dots\dots\dots [\text{Eq.VIII-1}]$**

as the Jeans-Length precursor or progenitor for subsequent stellar and galactic generation.

The ylemic (Jeans) radii are all independent of the mass of the star as a function of its nuclear generated temperature.

Applied to the proto stars of the vortex neutron matter or ylem, the radii are all neutron star radii and define a specific range of radii for the gravitational collapse of the electron degenerate matter.

These spans from the 'First Three Minutes' scenario of the cosmogenesis to 1.1 million seconds (or about 13 days) and encompasses the standard beta decay of the neutron, underpinning radioactivity.

The upper limit defines a trillion-degree temperature and a radius of over 40 km; the trivial Schwarzschild solution gives a typical ylem radius of so 7.4 kilometers and the lower limit defines the 'mysterious' planetesimal limit as 1.8 km.

For long a cosmological conundrum, it could not be modelled just how the molecular and electromagnetic forces applicable to conglomerate matter distributions (say gaseous hydrogen as cosmic dust) on the quantum scale of molecules could become strong enough to form say 1 km mass concentrations, required for 'ordinary' gravity to assume control.

The ylem radii's lower limit is defined in the cosmology as the Dirac monopole wavelength modulation at the 1.0 – 1.2 billion Kelvin degree marking the temperature of the universe in its defining Hawking-Gamow micro-mass black holes, which apply the Jeans formulation of hydrogen clouds to the primordial ylemic dineutron scenario.

The stellar evolution from the ylemic (di-neutronic) templates is well established in QR and confirms most of the Standard Model's ideas of nucleosynthesis and the general cosmology for a thermodynamically expanding universe.

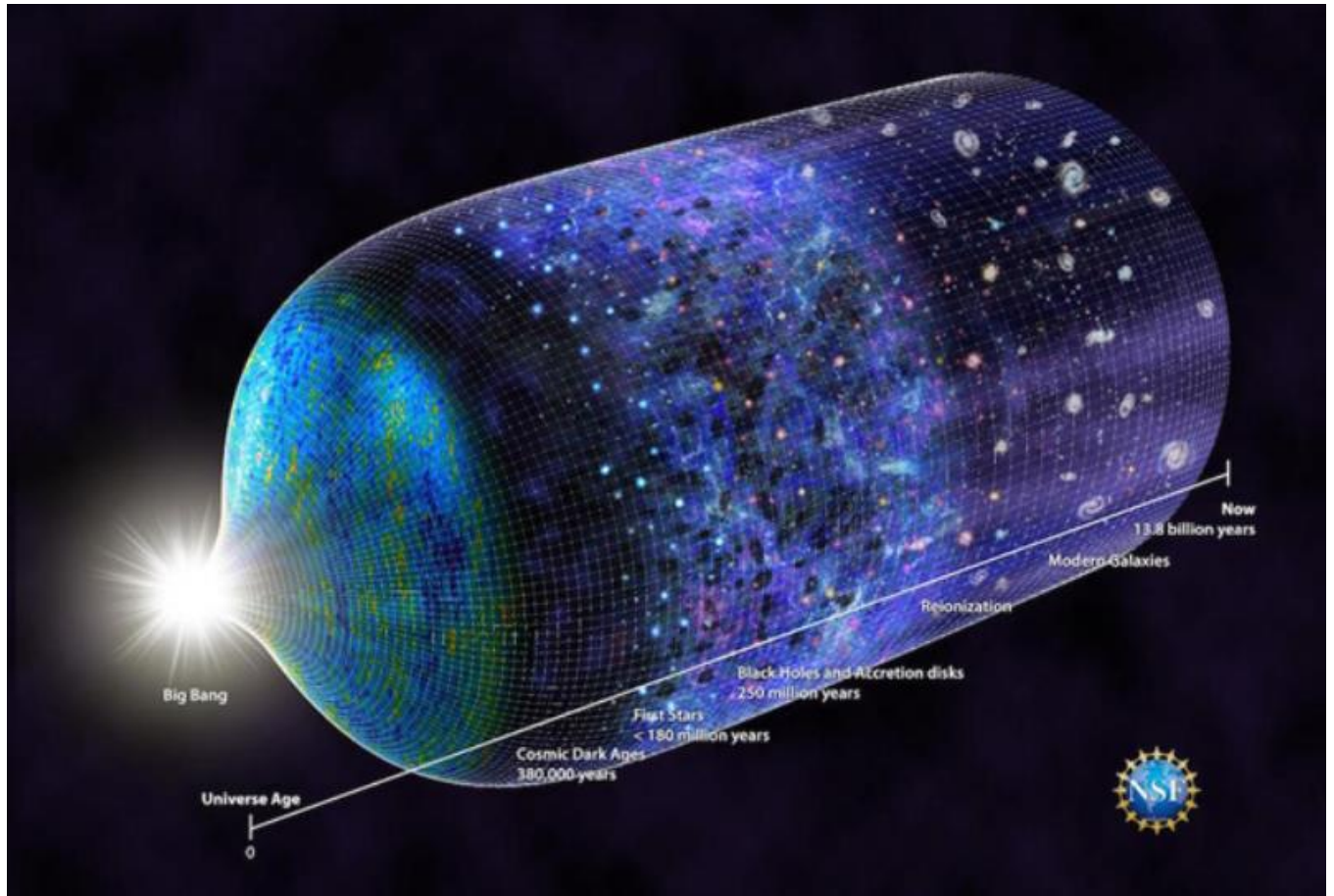

$n=H_0 t$ $t=$	Radius $m^*$ $R(n)=R_H/[n+1]$	Mod factor	Quantum Modulation	Cosmologica l comoving redshift $z+1=v\{1+2/n$ $[n+2]\}$ Energy $J^*/GeV^*$	Temperature CBBR $T=$ $\sqrt[4]{\{18.2(n+1)^2/n$ $\}^3}$ of cycle time $n$ $T_{Hawking}/T_{ylem} = 1$ $= hcR_e^3/$ $2\pi G_0 m_c^2 R_{ylem}^2 R$ Hawking Boson Energy $E=k_B T$	Hawking $\mu bh$ Radius Ylem Radius Hawking Mass	Hawking Temp $T_{Hawking}=hc^3/4\pi k_B G_0 M_{Hawki}$ $ng$ Ylem Radius $R_{ylem}=v\{k_B T R_e^3/G_0 m_c^2\}$ Hawking Radius $R_{Hawking}=hc/2\pi k_B T_{Hawking}$ Hawking Mass $M_{Hawking}=R_{Hawking} c^2/2G_0$
$2.559 \times 10^{-12}$ 15.77 days	$\lambda^*=4.087933536 \times 10^{14}$ Monopolar mean classical bound	$2\pi r^* \lambda^*$ MQB=1 .351	$2\pi r^*=3.30485 \times 10^{-15}$ Monopolar mean quantum bound	625,160.7	$1.0210 \times 10^9 K^*$ $1.44 \times 10^{-14}$ $J^*/89.723 \text{ keV}^*$	$2.2084 \times 10^{-12} m^*$ 1,680.10 $m^*$ $8.9440 \times 10^{14} \text{ kg}^*$	$R_{ylem}=R_{curv}$ for $M_{ylem}=6.80 \times 10^{29}$ $\text{kg}^*/0.340 M_{sun}$
$2.253 \times 10^{-12}$ $1.2 \times 10^6 s^*$ 13.888 days	$R_e^*=3.6 \times 10^{14} \text{ as}$ $360 \times R_e \times 10^{12}=1/R_e^*$	1	$R_e^*=R_e=10^{10} \lambda_{ps}/360$	666,181.2	$1.1231 \times 10^9 K^*$ $1.59 \times 10^{-14}$ $J^*/98.696 \text{ keV}^*$	$2.0076 \times 10^{-12} m^*$ 1,762.10 $m^*$ $8.1309 \times 10^{14} \text{ kg}^*$	unity modulation bounded by Dirac's monopole $R_{ylem}=R_{curv}$ for $M_{ylem}=7.14 \times 10^{29}$ $\text{kg}^*/0.357 M_{sun}$

2.151x 10 <sup>-12</sup> 13.256 1 days	$R_E = \sqrt[3]{E(\lambda_{weyl}/2\pi)} = 3.4359$ 7108x10 <sup>14</sup>	$R_E R_e$ 0.9544	$R_e = 2.7778 \times 10^{-15}$	681,897.2	1.1630x10 <sup>9</sup> K* 1.64x10 <sup>-14</sup> J*/102.20 keV*	1.9387x1 0 <sup>-12</sup> m* 1,793.13 7 m* 7.8519x1 0 <sup>-14</sup> kg*	$R_{ylem} = R_{curv}$ for $M_{ylem} = 7.26 \times 10^{29}$ kg*/0.363M <sub>sun</sub>
4.895x 10 <sup>-14</sup> 26,069 .4 s* 7.24 hours	7.82083x10 <sup>12</sup>	4.945x1 0 <sup>-4</sup>	6.32267x10 <sup>-17</sup>	4.5198x10 <sup>6</sup>	1.9847x10 <sup>10</sup> K* 2.80x10 <sup>-13</sup> J*/1.744 MeV*	1.1361x1 0 <sup>-13</sup> m* 7,407.40 7 m* 4.6011x1 0 <sup>-13</sup> kg*	Nuclear density $\rho_{nuc} = 3m_c \gamma^n / 4\pi \{R_e\}^3$ (1.105-1.907)x10 <sup>16</sup> [kg/m <sup>3</sup> ]* $R_{ylem} = V\{3k_B T / 4\pi G_0 m_c \rho_{nuc}\}$ for 1.5 M <sub>sun</sub> $M = \sum m_{ss} = \sum h f_{ss} / c^2$ mass quantization for space quanta count $M / \sum m_{ss} = h / m_{ss} c^2 = h f_{ps} / h = f_p$ $s  _{mod} = 3 \times 10^{30}$ as $M_{chandra} = 1.50 M_{sun}$
2.117x 10 <sup>-14</sup> 11,274 .58 s* 3.132 hours	3.38237x10 <sup>12</sup>	9249x1 0 <sup>-5</sup>	2.73445x10 <sup>-17</sup>	6.8728x10 <sup>6</sup>	3.7215x10 <sup>10</sup> K* 5.25x10 <sup>-13</sup> J*/3.270 MeV*	6.05875x 10 <sup>-14</sup> m* 10,143.3 4 m* 2.4538x1 0 <sup>-13</sup> kg*	$R_{Hawking} = R_e / 2\pi \alpha =$ Compton radius Ess modulation Electron degeneracy core for neutron stars $R_{ylem} = R_{curv}$ for $M_{ylem} = 4.11 \times 10^{30}$ kg*/2.054M <sub>sun</sub>
1.938x 10 <sup>-14</sup> 10,320 .0 s* 2.87 hours	3.0959915x10 <sup>12</sup>	7.749x1 0 <sup>-5</sup>	2.502924x10 <sup>-17</sup>	7.1836x10 <sup>6</sup>	3.9768x10 <sup>10</sup> K* 5.61x10 <sup>-13</sup> J*/3.495 MeV*	5.6698x1 0 <sup>-14</sup> m* 10,485.5 5 m* 2.2963x1 0 <sup>-13</sup> kg*	Modulation MQB/0.9544=1.41555 for M <sub>chandra</sub> lower Tolman- Oppenheimer-Volkoff (TOV) limit for neutron stars $R_{ylem} = R_{curv}$ for $M_{ylem} = 4.25 \times 10^{30}$ kg*/2.123 M <sub>sun</sub>
1.013x 10 <sup>-14</sup> 5395.0 5 s* 1.50 hours	1.618509x10 <sup>12</sup>	2.1x10 <sup>-5</sup>	1.3084678x10 <sup>-17</sup>	9.9354x10 <sup>6</sup>	6.4684x10 <sup>10</sup> K* 9.13x10 <sup>-13</sup> J*/5.684 MeV*	3.4858x1 0 <sup>-14</sup> m* 13,372.8 4 m* 1.4117x1 0 <sup>-13</sup> kg*	Neutron decay mass loss: 8.844/4.900=1.805 Increases M <sub>chandra</sub> to 1.805M <sub>chandra</sub> =2.708 M <sub>sun</sub> as upper TOV-limit for neutron stars $R_{ylem} = R_{curv}$ for $M_{ylem} = 5.42 \times 10^{30}$ kg*/2.708 M <sub>sun</sub>
4.028x 10 <sup>-15</sup> 2144.9 6 s* 32.749 min	6.43488x10 <sup>11</sup>	3.348x1 0 <sup>-6</sup>	5.20221x10 <sup>-18</sup>	1.5757x10 <sup>7</sup>	1.2919x10 <sup>11</sup> K* 1.82x10 <sup>-12</sup> J* /11.35 MeV*	1.7453x1 0 <sup>-14</sup> m* 18,899.0 0 m* 7.0686x1 0 <sup>-12</sup> kg*	$R_{Hawking} = 2\pi R_e$ $R_{ylem} = R_{curv}$ for $M_{ylem} = 7.65 \times 10^{30}$ kg*/3.827M <sub>sun</sub>
2.160x 10 <sup>-15</sup> 1150.3 6 s* 19.173 min	$R_F = \sqrt[3]{F(\lambda_{weyl}/2\pi)} = 3.4510$ 7750x10 <sup>11</sup>	9.6x10 <sup>-7</sup>	$R_f = 2.789990 \times 10^{-18}$	2.15163x10 <sup>7</sup>	2.0614x10 <sup>11</sup> K* 2.91x10 <sup>-12</sup> J*/18.12 MeV*	1.0938x1 0 <sup>-14</sup> m* 23,872.8 7 m* 4.4299x1 0 <sup>-12</sup> kg*	$R_{ylem} = R_{curv}$ for $M_{ylem} = 9.67 \times 10^{30}$ kg*/4.834M <sub>sun</sub>
2.123x 10 <sup>-15</sup> 1130.5 2 s* 18.842 0 min	$R_G = \sqrt[3]{G(\lambda_{weyl}/2\pi)} = 3.3915$ 5801x10 <sup>11</sup>	9.3x10 <sup>-7</sup>	$R_g = 2.741872 \times 10^{-18}$	2.17042x10 <sup>7</sup>	2.0885x10 <sup>11</sup> K* 2.95x10 <sup>-12</sup> J*/18.35 MeV*	1.0796x1 0 <sup>-14</sup> m* 24,029.2 8 m* 4.3724x1 0 <sup>-12</sup> kg*	$R_{ylem} = R_{curv}$ for $M_{ylem} = 9.73 \times 10^{30}$ kg*/4.866M <sub>sun</sub>

2.084x 10 <sup>-15</sup> 1109.9 6 s* 18.499 min	$R_F = \sqrt[3]{F'}(\lambda_{\text{weyl}}/2\pi) = 3.329$ $87275 \times 10^{11}$	$9.0 \times 10^{-7}$	$R_F = 2.69200 \times 10^{-18}$	$2.19044 \times 10^7$	$2.1175 \times 10^{11} \text{ K}^*$ $2.99 \times 10^{-12}$ $J^*/18.61 \text{ MeV}^*$	$1.0648 \times 10^{-14} \text{ m}^*$ 24,195.5 4 m* 4.3125x1 0 <sup>12</sup> kg*	Primordial neutron decay: $\lambda_F - 2\pi\lambda_{\text{RMP}}$ (1109.96-229.82) s* = 880.14 s*/879.28 s from Higgs Boson with RMP template Neutron decay mass loss: 8.844/4.900=1.805 Increases $M_{\text{chandra}}$ to 1.805 $M_{\text{chandra}} = 2.708 M_{\text{sun}}$ as upper TOV-limit for neutron stars $R_{\text{ylem}} = R_{\text{curv}}$ for $M_{\text{ylem}} = 9.80 \times 10^{30}$ kg*/4.900 $M_{\text{sun}}$
8.754x 10 <sup>-16</sup> 466.18 6 s* 7.770 min	$1.39856 \times 10^{11}$	$1.6 \times 10^{-7}$	$8.5232 \times 10^{-19}$	$3.89284 \times 10^7$	$5.0167 \times 10^{11} \text{ K}^*$ $7.08 \times 10^{-12}$ $J^*/44.09 \text{ MeV}^*$	$5.55556 \times 10^{-15} \text{ m}^*$ 33,497.3 3 m* 2.2500x1 0 <sup>12</sup> kg*	$R_{\text{Hawking}} = 2R_e$ $R_{\text{ylem}} = R_{\text{curv}}$ for $M_{\text{ylem}} = 1.3566 \times 10^{31}$ kg*/6.78 $M_{\text{sun}}$
4.315x 10 <sup>-16</sup> 229.82 1 s* 3.8304 min	$R_{\text{neutron decay}} = 6.8946323 \times 10^{10}$	$3.8 \times 10^{-8}$	$2\pi\lambda_{\text{RMP}} = 4\pi^2 R_{\text{RMP}} = 5.57$ $389763 \times 10^{-19}$	$4.81381 \times 10^7$	$6.89874 \times 10^{11} \text{ K}^*$ $9.74 \times 10^{-12}$ $J^*/60.62 \text{ MeV}^*$	$3.2684 \times 10^{-15} \text{ m}^*$ 43,672.5 4 m* 1.3237x1 0 <sup>12</sup> kg*	Beginning of neutron decay from Higgs Boson with RMP template $R_{\text{ylem}} = R_{\text{curv}}$ for $M_{\text{ylem}} = 1.77 \times 10^{31}$ kg*/8.844 $M_{\text{sun}}$
3.474x 10 <sup>-16</sup> 185.00 6 s* 3.083 min	$5.550187 \times 10^{10}$	$2.5 \times 10^{-8}$	$4.486994 \times 10^{-19}$	$5.36526 \times 10^7$	$8.1172 \times 10^{11} \text{ K}^*$ $1.15 \times 10^{-11}$ $J^*/71.33 \text{ MeV}^*$ to $3.1636 \times 10^{12} \text{ K}^*$	$2.7778 \times 10^{-15} \text{ m}^*$ 47,372.4 0 m* 1.1250x1 0 <sup>12</sup> kg*	$R_{\text{Hawking}} = R_e$ limited by $\rho_{\text{nucleon}} = m_c/R_e^3$ Nuclear density $\rho_{\text{nuc}} = 3m_c Y^n / 4\pi\{R_e\}^3$ (1.105-1.907)x10 <sup>16</sup> [kg/m <sup>3</sup> ]* $R_{\text{ylem}} = R_{\text{curv}}$ for $M_{\text{ylem}} = 1.92 \times 10^{31}$ kg*/9.593 $M_{\text{sun}}$
1.829x 10 <sup>-16</sup> 97.398 s* 1.623 min	$2.921968 \times 10^{10}$	$6.9 \times 10^{-9}$	$2.362236 \times 10^{-19}$	$7.39446 \times 10^7$	$1.3134 \times 10^{12} \text{ K}^*$ $1.85 \times 10^{-11}$ $J^*/115.4 \text{ MeV}^*$ to $1.3401 \times 10^{13} \text{ K}^*$	$1.7168 \times 10^{-15} \text{ m}^*$ 60,257.9 4 m* 6.9529x1 0 <sup>11</sup> kg*	$R_{\text{Hawking}} = XR_e$ limited by $\rho_{\text{nucleon}} = Y^2 m_c / R_e^3$ Nuclear density $\rho_{\text{nuc}} = 3m_c Y^n / 4\pi\{XR_e\}^3$ (4.683-8.077)x10 <sup>16</sup> [kg/m <sup>3</sup> ]* $R_{\text{ylem}} = R_{\text{curv}}$ for $M_{\text{ylem}} = 2.44 \times 10^{31}$ kg*/12.202 $M_{\text{sun}}$
1.379x 10 <sup>-16</sup> 73.422 s* 1.224 min	$2.202648 \times 10^{10}$	$3.9 \times 10^{-9}$	$1.780709 \times 10^{-19}$	$8.51671 \times 10^7$	$1.6234 \times 10^{12} \text{ K}^*$ $2.29 \times 10^{-11}$ $J^*/142.7 \text{ MeV}^*$ to $2.5309 \times 10^{13} \text{ K}^*$	$1.3889 \times 10^{-15} \text{ m}^*$ 66,994.0 7 m* 5.6250x1 0 <sup>11</sup> kg*	$R_{\text{Hawking}} = \frac{1}{2}R_e = \text{protonic}$ diameter limited by $\rho_{\text{nucleon}} = 8m_c / R_e^3$ Nuclear density $\rho_{\text{nuc}} = 3m_c Y^n / 4\pi\{\frac{1}{2}R_e\}^3$ (8.844-15.253)x10 <sup>16</sup> [kg/m <sup>3</sup> ]* $R_{\text{ylem}} = R_{\text{curv}}$ for $M_{\text{ylem}} = 2.71 \times 10^{31}$ kg*/13.566 $M_{\text{sun}}$

7.258x 10 <sup>-17</sup> 38.650 s*	1.159515x10 <sup>10</sup>	1.1x10 <sup>-9</sup>	9.37398x10 <sup>-20</sup>	1.17383x10 <sup>8</sup>	2.6268x10 <sup>12</sup> K* 3.71x10 <sup>-11</sup> J*/230.8 MeV* to 1.0721x10 <sup>14</sup> K*	8.5838x1 0 <sup>-16</sup> m* 85,218.2 7 m* 3.4764x1 0 <sup>11</sup> kg*	R <sub>Hawking</sub> =½XR <sub>e</sub> limited by ρ <sub>nucleon</sub> =8Y <sup>3</sup> m <sub>c</sub> /R <sub>e</sub> <sup>3</sup> Nuclear density ρ <sub>nuc</sub> =3m <sub>c</sub> Y <sup>0</sup> /4π{½XR <sub>e</sub> } <sup>3</sup> (3.746-6.461)x10 <sup>17</sup> [kg/m <sup>3</sup> ]* R <sub>ylem</sub> =R <sub>curv</sub> for M <sub>ylem</sub> =3.45x10 <sup>31</sup> kg*/17.257M <sub>sun</sub>
5.664x 10 <sup>-17</sup> 30.164 s*	9.04906x10 <sup>9</sup>	6.6x10 <sup>-10</sup>	7.31562x10 <sup>-20</sup>	1.32875x10 <sup>8</sup>	3.163603x10 <sup>12</sup> K* 4.47x10 <sup>-11</sup> J*/278.0 MeV*	7.1272x1 0 <sup>-16</sup> m* 93,522.1 6 m* 2.8865x1 0 <sup>11</sup> kg*	For electron degeneracy ρ <sub>nucleon</sub> =m <sub>c</sub> /R <sub>e</sub> <sup>3</sup> for a temperature limit of T <sub>Hawking</sub> =m <sub>c</sub> c <sup>2</sup> /2k <sub>B</sub> =3.16360 3x10 <sup>12</sup> K* = Neutron star- black hole limit ρ <sub>nucleon</sub> =ρ <sub>BH</sub> R <sub>ylem</sub> =R <sub>curv</sub> for M <sub>ylem</sub> =3.7876x10 <sup>31</sup> kg*/18.938M <sub>sun</sub>
2.996x 10 <sup>-17</sup> 15.957 s*	4.78696x10 <sup>9</sup>	1.9x10 <sup>-10</sup>	3.86997x10 <sup>-20</sup>	1.82690x10 <sup>8</sup>	5.1002x10 <sup>12</sup> K* 7.20x10 <sup>-11</sup> J*/448.2 MeV*	4.42097x 10 <sup>-16</sup> m* 118,744. 56 m* 1.7905x1 0 <sup>11</sup> kg*	R <sub>Hawking</sub> =R <sub>e</sub> /2π Ess modulation Neutron degeneracy R <sub>ylem</sub> =R <sub>curv</sub> for M <sub>ylem</sub> =4.81x10 <sup>31</sup> kg*/24.05M <sub>sun</sub>
8.264x 10 <sup>-18</sup> 4.401 s*	1.320239x10 <sup>9</sup>	1.4x10 <sup>-11</sup>	1.0673343x10 <sup>-20</sup>	3.4787x10 <sup>8</sup>	1.340124x10 <sup>13</sup> K* 1.53x10 <sup>-10</sup> J*/954.8 MeV*	1.6825x1 0 <sup>-16</sup> m* 192,484. 62 m* 6.8141x1 0 <sup>10</sup> kg*	For neutron degeneracy in the diameter of a protonic nucleus ρ <sub>nucleon</sub> =Y <sup>3</sup> m <sub>c</sub> R <sub>e</sub> R <sub>ylem</sub> =R <sub>curv</sub> for M <sub>ylem</sub> =7.7956x10 <sup>31</sup> kg*/38.978M <sub>sun</sub>
3.540x 10 <sup>-18</sup> 1.885 s*	5.65566x10 <sup>8</sup>	2.6x10 <sup>-12</sup>	4.572262x10 <sup>-21</sup>	5.3150x10 <sup>8</sup>	2.530882x10 <sup>13</sup> K* 3.57x10 <sup>-10</sup> J*/2.22 GeV*	8.9090x1 0 <sup>-17</sup> m* 264,520. 60 m* 3.6081x1 0 <sup>10</sup> kg*	For neutron degeneracy in the radial size of a protonic nucleus ρ <sub>nucleon</sub> =8m <sub>c</sub> 3R <sub>e</sub> <sup>3</sup> R <sub>ylem</sub> =R <sub>curv</sub> for M <sub>ylem</sub> =1.07131x10 <sup>32</sup> kg*/53.565M <sub>sun</sub>
5.165x 10 <sup>-19</sup> 0.2750 5 s*	8.251498x10 <sup>7</sup>	5.5x10 <sup>-14</sup>	6.670843x10 <sup>-22</sup>	1.3915x10 <sup>9</sup>	1.072099x10 <sup>14</sup> K* 1.51x10 <sup>-9</sup> J*/9.42 GeV*	2.1031x1 0 <sup>-17</sup> m* 544,428. 68 m* 8.5177x1 0 <sup>9</sup> kg*	For neutron degeneracy in the charge radius of a proton ρ <sub>nucleon</sub> =8Y <sup>3</sup> m <sub>c</sub> R <sub>e</sub> <sup>3</sup> = Quark star limit R <sub>ylem</sub> =R <sub>curv</sub> for M <sub>ylem</sub> =2.20494x10 <sup>32</sup> kg*/110.247M <sub>sun</sub>
4.917x 10 <sup>-19</sup> 0.2618 s*	7.85497x10 <sup>6</sup>	4.9x10 <sup>-16</sup>	6.23027x10 <sup>-23</sup>	1.4262x10 <sup>9</sup>	1.11243x10 <sup>14</sup> K* 1.57x10 <sup>-9</sup> J*/9.78 GeV*	2.0269x1 0 <sup>-17</sup> m* 554,574. 32 m* 8.2089x1 0 <sup>9</sup> kg*	R <sub>Hawking</sub> = α R <sub>e</sub> = Inverse Compton radius R <sub>ylem</sub> =R <sub>curv</sub> for M <sub>ylem</sub> =2.25x10 <sup>32</sup> kg*/112.30M <sub>sun</sub>



1.340x 10 <sup>-20</sup> 1/140 =0.007 137	R <sub>EW</sub> =2.141143x10 <sup>6</sup> Dark matter universe is illuminated as the EMI light path intersects the dark matter haloed ylemic universe	3.7x10 <sup>-17</sup>	1.730986x10 <sup>-23</sup> Ylemic radius shrinks as the radial universe expands with the separation of the short range nuclear weakon interaction from the long-range electromagnetic interaction	8.6382x10 <sup>9</sup>	1.65825x10 <sup>15</sup> K* 2.34x10 <sup>-8</sup> J*/146 GeV*	1.3597x10 <sup>-18</sup> m* 2.14115x10 <sup>6</sup> m* 5.5069x10 <sup>8</sup> kg*	Electroweak Unification T <sub>EW</sub> =E/k <sub>B</sub> =2x10 <sup>15</sup> K* (146-251)GeV* for {W <sup>-</sup> +W <sup>+</sup> +Z <sup>0</sup> } R <sub>ylem</sub> = R(n) as size of the universe Dark matter halo defined as a quark-lepton geometric kernel-ring structure crystallizing the ylem neutrons from the Higgs Boson and RMP template R <sub>ylem</sub> =R <sub>curv</sub> for M <sub>ylem</sub> =8.67x10 <sup>32</sup> kg*/433.67M <sub>sun</sub>
6.958x 10 <sup>-22</sup> 0.0003 7	111,173.6	1.0x10 <sup>-19</sup>	8.98772x10 <sup>-25</sup>	3.791x10 <sup>10</sup> 1.799x10 <sup>-30</sup> J* 1.120x10 <sup>-11</sup> eV*	1.52452x10 <sup>16</sup> K* 2.15x10 <sup>-7</sup> J*/1.34 TeV*	1.4790x10 <sup>-19</sup> m* 6.4921x10 <sup>6</sup> m* 5.9898x10 <sup>7</sup> kg*	R <sub>Hawking</sub> =α <sup>2</sup> R <sub>e</sub> = Inverse 1 <sup>st</sup> Bohr radius for ylemic template for atomic structure as micro-Hawking black hole to manifest at R <sub>Hawking</sub> /α <sup>4</sup> =9.798883x10 <sup>-7</sup> m* R <sub>ylem</sub> =R <sub>curv</sub> for M <sub>ylem</sub> =2.63x10 <sup>33</sup> kg*/1314.7M <sub>sun</sub>
3.562x 10 <sup>-27</sup> 1.897x 10 <sup>-9</sup>	R <sub>BU</sub> =0.569092 universe is 1.1382 meters across encompassed by a ylem dark matter halo of radius 6.2584x10 <sup>8</sup> m* in the inflaton EMMI universe	4.0x10 <sup>-28</sup>	7.038245x10 <sup>-28</sup> Ylemic universe is manifested in the primordial Hawking micro black hole defining the dark matter ylemic halo	1.676x10 <sup>12</sup> 3.515x10 <sup>-25</sup> J* 2.19x10 <sup>-6</sup> eV*	T <sub>ps</sub> =1.4167x10 <sup>20</sup> K* 0.002 J*/12,449.8 TeV*	1.59155x10 <sup>-23</sup> m* 6.2584x10 <sup>8</sup> m* 6445.78 kg*	Bosonic temperature unification T(n)= <sup>4</sup> √{(H <sub>0</sub> <sup>3</sup> M <sub>o</sub> /1100π <sup>2</sup> σ)}.{(n+1) <sup>2</sup> /n <sup>3</sup> } = <sup>4</sup> √{18.2(n+1) <sup>2</sup> /n <sup>3</sup> }=T <sub>ps</sub> =1.4167x10 <sup>20</sup> K* R <sub>ylem</sub> =R <sub>curv</sub> for M <sub>ylem</sub> =2.53x10 <sup>35</sup> kg*/126,732.0M <sub>sun</sub>

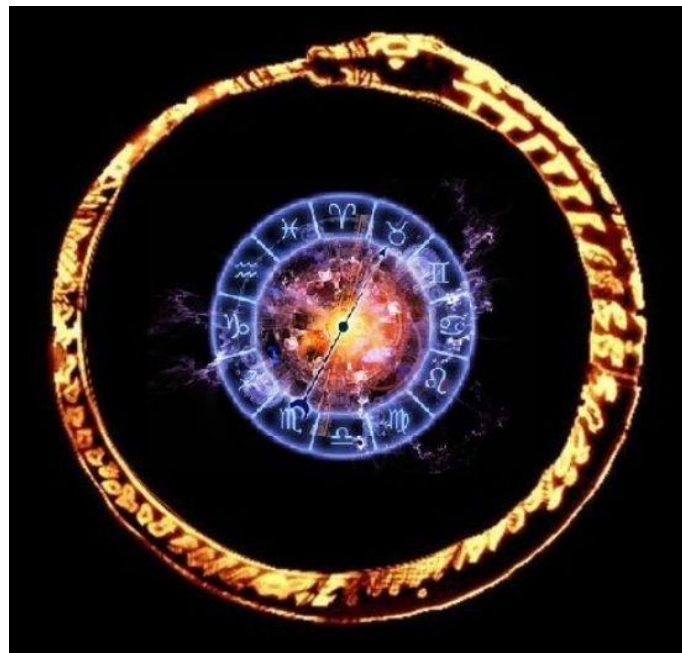

## Quantum Geometric Temperature/Radius Displacement Unification

Cosmic Radius of Black Body Planck Radiator Expansion

Boson Radius of Quantum Geometric Conformal Scaling

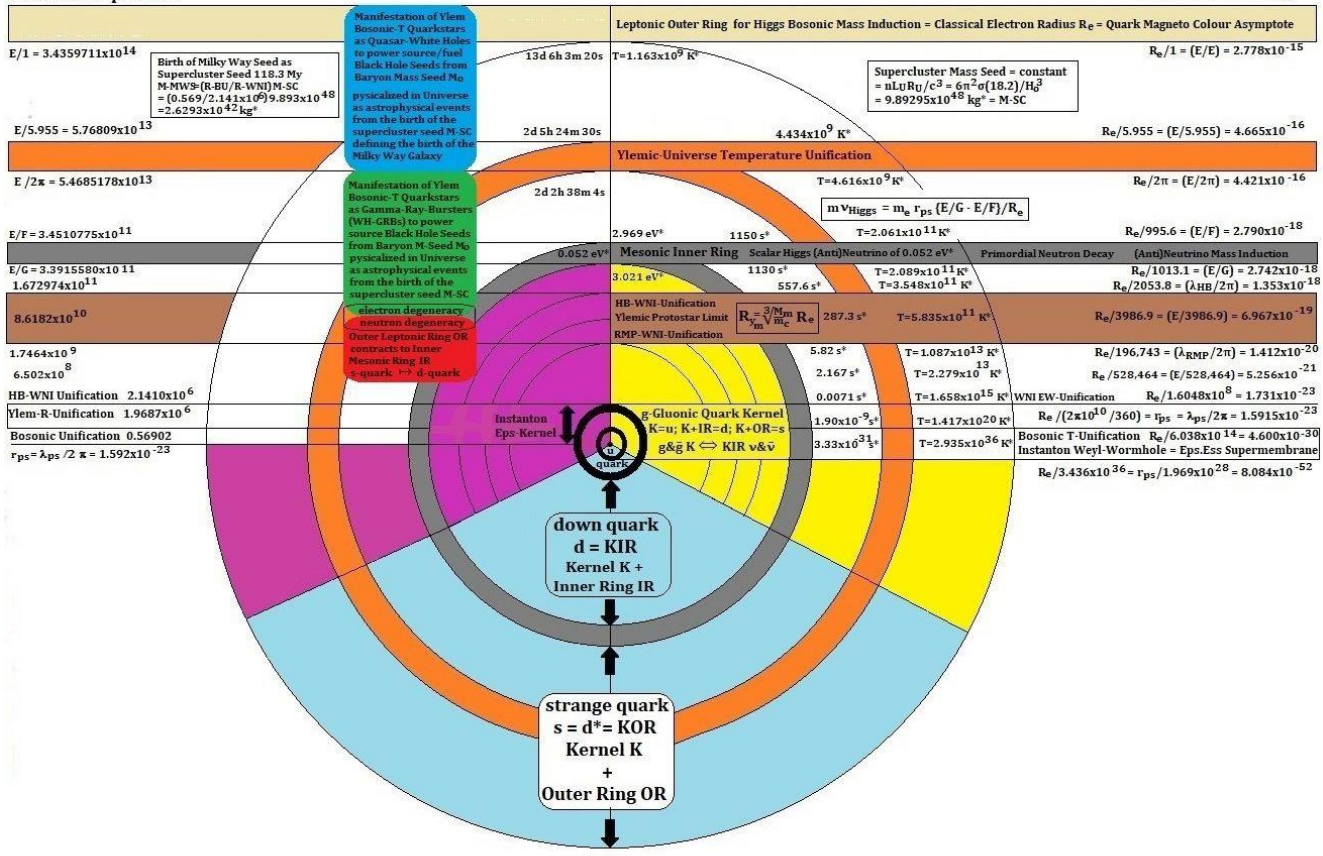

The standard model is correct in the temperature assignment but is amiss in the corresponding 'size-scales' for the cosmic expansion. The Big Bang cosmogenesis describes the universe as a Planck-Black Body Radiator, which sets the Cosmic-Microwave-Black Body Background Radiation Spectrum (CMBR) as a function of  $n$  as  $T^4 = 18.2(n+1)^2/n^3$  and derived from the Stefan-Boltzmann-Law and the related statistical frequency distributions.

The metric from General Relativity for Schwarzschild-Black Hole Evolution has  $R_S = 2GM/c^2$  as a function of the star's Black Hole's mass  $M$  and we have the ylemic Radius as a function of temperature only as  $R_{ylem} \propto \sqrt{(k_B T \cdot R_e^3 / G_0 m_c^2)}$ .

The nucleonic mass-seed  $m_c = m_{planck} \alpha^9$  and the product  $G_0 m_c^2$  is a constant in the partitioned evolution of  $m_c(n) = Y^n \cdot m_c$  and  $G(n) = G_0 \cdot X^n$ .

Identifying the ylemic Radius with the Hawking radius gives the properties of the micro-mass black hole at the temperature of the universe and identifying the ylemic radius with a standard Schwarzschild radius gives the properties of neutron-quark stars at their local temperatures as manifesting vortex energies from their Hawking-Gamow ylemic seedling black holes at a later  $n$ -cycle coordinate and in a later and cooler universe.

Quantum Relativity (QR) defines the Weyl-Temperature limit for Bosonic Unification as 1.9 nanoseconds at a temperature of  $1.42 \times 10^{20}$  Kelvin and the weak-electromagnetic unification at 1/140 seconds or 7 microseconds at  $T = 1.68 \times 10^{15}$  K\*.

The earliest ylem stars are limited at a temperature of  $1.68 \times 10^{15}$  K\* at the electroweak unification nexus with a mass limit of  $433.58 M_{\text{sun}}$  or  $8.672 \times 10^{32}$  kg\* as the first potential for an ylemic proto-star after the bosonic unification and after the undifferentiated 'bosonic plasma' entered its phase of the QBBS temperature no longer exceeding the temperature and energy of individualised elementary particles, enabling the di-neutrons to be born as ylem or Gamow's neutron matter.

185 seconds or 3 minutes after the Instanton, the universe was so 111 Million km across, when its ylemic 'concentrated' VPE-Temperature was so 812 Billion K\* and the Hawking radius was the same as the radius of the classical electron for a micro black hole mass of  $1.1 \times 10^{12}$  kg\* and an ylem radius of 47.4 km\* indicating a future black hole macro-mass of  $1.9 \times 10^{31}$  kg\* as  $9.6 M_{\text{sun}}$  as a limiting quark gluon-plasma star.

The 'pixelated' universe so became scaled in ylemic temperature bubbles in the form of primordial White-Hole-Sources coupled to Black Hole-Sinks in a form of macro quanta to reflect the sourcesink Eps coupled to the sinksource Ess of the underpinning elementary super membrane Eps.Ess. As the universe continued its expansion, the WH-BH dyads remained as temperature hotspots embedded within the cooling spacetime as the Black Body Radiator of the cosmogenesis.

As the universe expanded and cooled, the first ylem stars crystallized from the mass seedling  $M_0$ . The universe's expansion however cooled the CMBR background and as the temperature characterizing the Chandrasekar white dwarf-neutron star limit is at a temperature of 20 Billion Kelvin, the size of the universe at this temperature provides an upper limit for the size of a star in  $7.8 \times 10^{12}$  m\* or a radius 7.8 billion kilometers. This encompasses about 52 Astronomical Units (1 AU =  $1.5 \times 10^8$  km as the distance between the earth and the sun) and so the radial extent and the 'size' of a typical solar system, encompassed by supergiants on the HR-diagram.

The ylemic temperature decreases in direct proportion to the square of the ylemic radius and one hitherto enigmatic aspect in cosmology relates to this in the planetesimal limit. A temperature of so 1.2 billion degrees defines an ylemic radius of 1.8 km as the dineutronic limit for proto-neutron stars contracting from 47.4 km\* down to this size just 1.1 million seconds or so 13 days after the Quantum Big Bang Dirac Singularity.

Chunks of matter can conglomerate via molecular and other adhesive interactions towards this size, where then the accepted gravity is strong enough to build planets and moons; but the ylemic template is defined in subatomic parameters reflecting the mesonic inner and leptonic outer ring boundaries and this the planetesimal limit becomes the modulation of the Dirac monopole wavelength as the mapping of the leptonic outer ring. So, neutrino-gluon and quark blueprints micro-macro dance their basic definition as the holographic projections of the space-time quanta.

The nuclear density for neutron stars for electron degeneracy at the leptonic ring is increased for neutron degeneracy at the mesonic ring and therefore modifies the Chandra mass limit for white dwarves in the Tolman-Oppenheimer-Volkoff (TOV) limit for neutron stars.

A lower limit for the TOV limit is obtained in the Dirac monopole modulation  $MQB/0.9544=1.41555$  increasing the Chandrasekar mass to  $1.5 \times 1.41555=2.123$  solar masses. The upper limit considers the primordial neutron decay as superimposed onto the ylemic mass evolution in the loss of neutrons between the mass content of the ylemic protostars at the beginning and the end of the primordial beta minus decay of lefthanded neutrons into lefthanded protons and lefthanded electrons with righthanded antineutrinos. At the beginning of the 880.14 seconds the ylemic Hawking mass would be 8.844 solar masses as a function of its radius and reducing to 4.900 solar masses at the end of neutron decay for a mass fraction of 1.804. The upper TOV limit for the Chandrasekar mass so becomes  $1.5 \times 1.804=2.706$  solar masses.

Hence any star experiencing electron degeneracy is actually becoming ylemic or dineutronic, the boundary for this process being the Chandrasekhar mass, extended to the TOV mass for neutron degeneracy. The ylemic protostar mass at the beginning of neutron decay also sets a natural limit for any stellar black holes in 8.844 solar masses or  $1.769 \times 10^{31}$  kg\*.

The density of a black hole is calculated from  $\rho_{BH}=M_{BH}/V_{BH}=M_{BH}c^6/8G_o^3M_{BH}^3=c^6/8G_o^3M_{BH}^2=c^2/2G_o r_{curv}^2=c^2/2G_o r_{ylem}^2=\{m_c c^2/2k_B T_{Hawking}\}\{m_c/R_e^3\}=\{m_c c^2/2k_B T_{Hawking}\}\{\rho_{nucleon}\}$

For Hawking's micro black holes activated as Gamow's ylemic protostars then, the relationship between the black hole density and the neutron star density becomes a function of the ylemic-universal temperature projected from the ylem time into the future time when the neutron stars, magnetars and quark stars would be born from as the remnants of supernovae or the merger of neutron stars with each other or black holes.

$k_B T_{Hawking}=\frac{1}{2}m_c c^2\{\rho_{nucleon}\}/\rho_{BH}$  and the limit for an electron degenerate star is given in the black hole density equal to the nucleon density for  $k_B T_{Hawking}=\frac{1}{2}m_c c^2$  and so for a temperature  $T_{Hawking}=m_c c^2/2k_B=3.163603 \times 10^{12}$  K\*

For electron degeneracy  $\rho_{nucleon}=m_c/R_e^3$ ; for a temperature limit of  $T_{Hawking}=m_c c^2/2k_B=3.163603 \times 10^{12}$  K\*  
For neutron degeneracy in the diameter of a protonic nucleus  $\rho_{nucleon}=Y^3 m_c R_e^3$ ; for a temperature limit of  $T_{Hawking}=Y^3 m_c c^2/2k_B=1.340124 \times 10^{13}$  K\*

For neutron degeneracy in the radial size of a protonic nucleus  $\rho_{nucleon}=8m_c 3R_e^3$ ; for a temperature limit of  $T_{Hawking}=8m_c c^2/2k_B=2.530882 \times 10^{13}$  K\*  
For neutron degeneracy in the charge radius of a proton  $\rho_{nucleon}=8Y^3 m_c R_e^3$ ; for a temperature limit of  $T_{Hawking}=8Y^3 m_c c^2/2k_B=1.072099 \times 10^{14}$  K\*

Considering the size of the proton for neutron degeneracy engages a displacement scale from 2.778 to 0.858 fermi in a factor of 3.235 for a change in the nuclear density in a factor of  $(3.235)^3=33.87$  from  $1.105 \times 10^{16} - 3.743 \times 10^{17}$  [kg/m<sup>3</sup>]\*.

Macrostate					Macrostate	
$T_{ps}  _{mod}$	←	$M_{curv}=R_{Hawking}c^2/2G_o$	←	$R_{Hawking}=hc/2\pi k_B T_{curv}$	←	$T_{ylem}$ as $T_{curv}$ as $T_{Hawking}$
$3.602774 \times 10^{-12} K^*$		$2.534656 \times 10^{35} kg^*$		$6.258410 \times 10^8 m^*$		$3.602774 \times 10^{-12} K^*$
$T_{ps}=1.41671 \times 10^{20} K^*$		$6.258410 \times 10^8 m^*$		$2.534656 \times 10^{35} kg^*$		$3.602774 \times 10^{-12} K^*$
$T_{Hawking}$	→	$R_{ylem}=\sqrt{\{k_B T_{Hawking} R_e^3 / G_o m_c^2\}}$	→	$M_{curv}=R_{ylem}c^2/2G_o$	→	$T_{curv}=hc/2\pi k_B R_{ylem}$
Macrostate						Macrostate
$T_{ps}=1.41671 \times 10^{20} K^*$		$r_{ps}=1.591549 \times 10^{-23} m^*$		$6445.775 kg^*$		$T_{ps}=1.41671 \times 10^{20} K^*$
$T_{Hawking}$	→	$R_{Hawking}=hc/2\pi k_B T_{Hawking}=R_{curv}$	→	$M_{curv}=R_{curv}c^2/2G_o$	→	$T_{Hawking}=hc/2\pi k_B R_{curv}$
Microstate						Microstate

For the Bosonic Temperature unification  $n_{BU}=H_o t_{BU}=3.562 \times 10^{-27}$  for  $T_{CMBR}=T_{ps}=1.417 \times 10^{20} K^*$  a Hawking radius  $R_{Hawking}=r_{ps}=hc/2\pi k_B T_{Hawking}=1.591 \times 10^{-23} m^*$  for a present micro black hole mass  $M_{ylem}=HM/T_{Hawking}=6445.78 kg^*$  infers a macrostate ylem radius  $6.258 \times 10^8 m^*$  as a Hawking microstate radius for a macrostate HM black hole mass of  $M_{curv}=HM/T_{ylem}=2.535 \times 10^{35} kg^*$ ; for a ylem temperature  $T_{ylem}=3.603 \times 10^{-12} K^*$  modulating the macrostate in the microstate as a minimum boundary self-state for the age of the universe.

Macrostate					Macrostate	
$T_{EW}  _{mod}$	←	$M_{curv}=R_{Hawking}c^2/2G_o$	←	$R_{Hawking}=hc/2\pi k_B T_{curv}$	←	$T_{ylem}$ as $T_{curv}$ as $T_{Hawking}$
$1.0530621 \times 10^{-9} K^*$		$8.671658 \times 10^{32} kg^*$		$2.14115 \times 10^6 m^*$		$1.0530621 \times 10^{-9} K^*$
$T_{EW}=1.65825 \times 10^{15} K^*$		$2.14115 \times 10^6 m^*$		$8.671658 \times 10^{32} kg^*$		$1.0530621 \times 10^{-9} K^*$
$T_{Hawking}$	→	$R_{ylem}=\sqrt{\{k_B T_{Hawking} R_e^3 / G_o m_c^2\}}$	→	$M_{curv}=R_{ylem}c^2/2G_o$	→	$T_{curv}=hc/2\pi k_B R_{ylem}$
Macrostate						Macrostate
$T_{EW}=1.65825 \times 10^{15} K^*$		$1.359725 \times 10^{-18} m^*$		$5.506886 \times 10^8 kg^*$		$T_{EW}=5.618369 \times 10^{12} K^*$
$T_{Hawking}$	→	$R_{Hawking}=hc/2\pi k_B T_{Hawking}=R_{curv}$	→	$M_{curv}=R_{curv}c^2/2G_o$	→	$T_{Hawking}=hc/2\pi k_B R_{curv}$
Microstate						Microstate

For the electroweak unification  $n_{EW}=H_o t_{EW}=1.340 \times 10^{-20}$  for  $T_{CMBR}=T_{EW}=1.658 \times 10^{15} K^*$  a Hawking radius  $R_{Hawking}=r_{EW}=hc/2\pi k_B T_{Hawking}=1.360 \times 10^{-18} m^*$  for a present micro black hole mass  $M_{ylem}=HM/T_{Hawking}=5.507 \times 10^8 kg^*$  infers a macrostate ylem radius  $2.141 \times 10^6 m^*$  as a Hawking microstate radius for a macrostate HM black hole mass of  $M_{curv}=HM/T_{ylem}=8.671 \times 10^{32} kg^*$ ; for a ylem temperature  $T_{ylem}=1.053 \times 10^{-9} K^*$  modulating the macrostate in the microstate as a minimum boundary self-state for the age of the universe.

Macrostate					Macrostate	
$T_{present}  _{mod}$	←	$M_{curv}=R_{Hawking}c^2/2G_o$	←	$R_{Hawking}=hc/2\pi k_B T_{curv}$	←	$T_{ylem}$ as $T_{curv}$ as $T_{Hawking}$
$0.02589 K^*$		$3.527 \times 10^{25} kg^*$		$0.08709 m^*$		$0.02589 K^*$
$T_{present}=2.747 K^*$		$0.08709 m^*$		$3.527 \times 10^{25} kg^*$		$0.02589 K^*$
$T_{Hawking}$	→	$R_{ylem}=\sqrt{\{k_B T_{Hawking} R_e^3 / G_o m_c^2\}}$	→	$M_{curv}=R_{ylem}c^2/2G_o$	→	$T_{curv}=hc/2\pi k_B R_{ylem}$
Macrostate						Macrostate
$T_{present}=2.747 K^*$		$8.208 \times 10^{-4} m^*$		$3.324 \times 10^{23} kg^*$		$T_{present}=2.747 K^*$
$T_{Hawking}$	→	$R_{Hawking}=hc/2\pi k_B T_{Hawking}=R_{curv}$	→	$M_{curv}=R_{curv}c^2/2G_o$	→	$T_{Hawking}=hc/2\pi k_B R_{curv}$
Microstate						Microstate

For a present n-cycle coordinate  $n_{\text{present}}=1.132712$  for  $T_{\text{CMBR}}=2.747 \text{ K}^*$  a Hawking radius

$R_{\text{Hawking}}=r_{\text{Hpresent}}=hc/2\pi k_B T_{\text{Hawking}}=8.208 \times 10^{-4} \text{ m}^*$  for a present micro black hole mass

$M_{\text{ylem}}=HM/T_{\text{Hawking}}=3.324 \times 10^{23} \text{ kg}^*$  infers a macrostate ylem radius  $0.0871 \text{ m}^*$  as a Hawking microstate radius for a macrostate HM black hole mass of  $M_{\text{curv}}=HM/T_{\text{ylem}}=3.527 \times 10^{25} \text{ kg}^*$ ; for a ylem temperature

$T_{\text{ylem}}=0.0259 \text{ K}^*$  modulating the macrostate in the microstate as a maximum boundary self-state for the age of the universe.

As the ylem radius is proportional to the square root of the ylem universal temperature but decreases with time in the universal temperature evolution for an increase in a black hole's radius; the increase of the ylem protostar mass with temperature is compensated in the inverse proportionality in the Hawking modulus in the radii of the ylem protostar and the curvature.

$$R_{\text{Hawking}} = hc/2\pi k_B T_{\text{Hawking}} = 2G_o M/c^2 = R_{\text{curv}} = R_{\text{ylem}} = \sqrt{\{k_B T R_e^3 / G_o m_c^2\}}.$$

Nuclear density then varies as  $\rho_{\text{nuclear}} = \{3c^4 k_B / 16\pi G_o^3 m_c\} T/M^2 = \{5.0129636 \times 10^{66}\} T/M^2$  which identifies the Chandra mass of 1.5 solar masses as  $f_{\text{ps}}^2 = 9 \times 10^{60}$  frequency states modulating the nuclear density for a temperature of  $1.9847 \times 10^{10} \text{ K}^*$  for a Hawking-Gamow micro black hole of mass  $4.6011 \times 10^{13} \text{ kg}^*$

$$T^3 = \{hc^3/4\pi k_B G_o\}^2 \rho_{\text{nuclear}} / \{5.013 \times 10^{66}\} = \rho_{\text{nuclear}} \{h^2 c^2 G_o m_c / 3\pi k_B^3\} [K^3]^* = \rho_{\text{nuclear}} \{1.66348029 \times 10^{-19}\} [K^3]^*$$

Nuclear densities for neutron stars, magnetars and quark-plasma stars so become restricted in the subatomic parameters on the fermi scale of at about half of the classical electron radius scale a Protonic Diameter, the Protonic Radius must then indicate the limit for the scale where proton degeneracy would have to enter the scenario.

As the proton cannot degenerate in that way, the neutron star must enter its Quark-Star Gluon-Plasma phase transition at the  $\frac{1}{2}R_e/Y$  scale, corresponding to a mass of  $2Y.M_{\text{Chandra}}=9.7082 \times 10^{30} \text{ kg}^*$  or 4.854 solar masses. This marker is between the F-googol and the G-googol space quanta counter nexus coordinates.

This vortex manifested as a VPE concentration after the expanding universe had cooled to allow the universe to become transparent from its hitherto defining state of opaqueness and a time known as the decoupling of matter (in the form of the  $M_o$  seedling partitioned in  $m_c$ 's) from the radiation pressure of the CMBR bosons.

Generally, when the gravitational inward pressure is larger than the thermal outward pressure for a star, then electron degeneracy can result in the atomic constituents of the star to break the electromagnetic force keeping the atoms electrons apart from the atomic nucleus. In the evolution of stars, the nuclear fusion processes in the core of the star determine how the mass of the star will respond to the release of material of the star in the form of electromagnetic radiation and mass ejections. Once the nuclear fusion processes can no longer convert atomic elements in endothermic reactions at the iron limit, the exothermic reactions will reduce the star's mass to that of its core.

Depending on the mass of this core, particular limits determine the fate of the star's core of either becoming a white dwarf in the Chandrasekhar limit of about 1.4 solar masses and increasing to 2-3 (Supernova SN2003fg~2.0) solar masses or the Tolman-Oppenheimer-Volkoff (TOV) limit of about 2.3 (Neutron Star GW170817) solar masses for a general range between 1.5 – 3 solar masses for neutron degenerate matter.

A neutron stars mass increases with the rate of rotation by about 20% from a non-rotating state. As the classical electron radius oscillates between the wormhole Weyl-radius of the QBBS as  $r_{ps}=\lambda_{ps}/2\pi =1.59155\times 10^{-23} \text{ m}^*$  and  $R_e=k_e e^2/m_e c^2 = h\alpha/2\pi m_e c =2.777\dots\times 10^{-15} \text{ m}^*$ ; the Compton constant  $R_e m_e = h\alpha/2\pi c = \alpha L_{\text{planck}} m_{\text{planck}} = \alpha \sqrt{\{(hG_o/2\pi c^3)(hc/2\pi G_o)\}}$   $=\alpha \sqrt{\{h^2/4\pi^2 c^2\}} = h\alpha/2\pi c = C_{\text{compton}} = R_{\text{eff}} \cdot m_{\text{eff}} = 2.580702 \times 10^{-45} \text{ [mkg]}^*$  will determine this electronic oscillation between the gluon-neutrino kernel and the inner mesonic ring and the outer leptonic ring for the subatomic structure of a nucleon or hadron.

In particular the effective charge radius of the proton of quark content u.d.u=KKIRK differing from the quark content of the neutron d.u.d=KIRKKIR by 1.328 MeV\* reduces the classical electron radius by the factor 1/2X to set.

$R_{\text{proton}} = 1/2 X R_e = 0.85838 \times 10^{-15} \text{ m}^*$  for an effective electron mass of  $m_{\text{eff}} = C_{\text{compton}}/R_{\text{eff}} = 3.00648 \times 10^{-30} \text{ kg}^*$  at that displacement in the classical electron oscillation. **[Footnote 2]**

At the scale of a protonic diameter  $m_{\text{eff}} = C_{\text{compton}}/X R_e = 1.50324 \times 10^{-30} \text{ kg}^*$ , showing that an increase of the electron's size will decrease its effective self-interacting electromagnetic mass, irrespective of the relativistic velocity of the electron.

[https://www.academia.edu/39184674/The Monopolar Quantum Relativistic Electron An Extension of the Standard Model and Quantum Field Theory Part 1](https://www.academia.edu/39184674/The_Monopolar_Quantum_Relativistic_Electron_An_Extension_of_the_Standard_Model_and_Quantum_Field_Theory_Part_1)

[https://www.academia.edu/40223805/A Revision of the Friedmann Cosmology](https://www.academia.edu/40223805/A_Revision_of_the_Friedmann_Cosmology)

The cosmology for the lower dimensional universe is described as the spacetime evolution of a Planck Black Body Radiator and so follows a thermodynamic process of a decreasing universal background temperature with increasing volume, due to the expansion of the universe.

The modular string-membrane dualities then couple the inversion displacement parameters of the QBBS and the micro-quantum scale of the instanton as a Weyl-Eps-wormhole in the supermembrane EpsEss evolution to the macro-quantum scale of the inflaton under utility of the ABCDEFGH googolplex spacetime quanta counters.

As the E-googol defines the quantum geometric template for the classical electron radius, rendered variable in the maximum of  $R_e = 2.777 \times 10^{-15} \text{ m}^*$  and the minimum in the wormhole radius  $r_{ps} = \lambda_{ps}/2\pi = 1.592 \times 10^{-23} \text{ m}^*$ , the magnitude ratio  $R_e/R_e = \sqrt[3]{E}(\lambda_{\text{weyl}}/2\pi)/\{10^{10}\lambda_{ps}/360\} = \sqrt[3]{E}(\lambda_{\text{weyl}}/2\pi)/\{2\pi r_{ps}10^{10}/360\} = \{\sqrt[3]{E}/10^{10}\}\{360/2\pi\}$   $= \{2.158884299\dots \times 10^{27}\}\{180/\pi\} = 3.43597108 \times 10^{14} \text{ m}^*/2.7777777 \times 10^{-15} \text{ m}^*$   $= 1.236949588\dots \times 10^{29} \text{ spacetime quanta}$ .

The wave nature of matter is given by the de Broglie wavelength for matter in

$\lambda_{\text{dB}} = 2\pi r_{\text{dB}} = h/p = h/m_{\text{electron}} v_{\text{electron}}$  for an elementary particle like the electron.

This is expressed for the particle nature of matter in the Compton wavelength  $\lambda_{\text{compton}} = 2\pi r_{\text{compton}} = h/m_{\text{electron}} c$  and maximizing the velocity of the electron to lightspeed c.

As the classical electron radius is  $R_e = k_e e^2/m_{\text{electron}} c^2 = \alpha h/2\pi m_{\text{electron}} c = \alpha r_{\text{compton}}$ , showing that increasing the size of the electron by a factor of 137 will define the light-matter interaction probability in the electromagnetic finestructure constant alpha for Compton radius  $r_{\text{compton}} = R_e/\alpha = 3.80686301 \times 10^{-13} \text{ m}^*$ .

It defines the Compton constant  $C_{\text{compton}} = R_e m_e = \alpha h / 2\pi c = R_{ec} m_{ec}$  for the inverse proportionality between the mass and the radial size of a particle or system in quantum mechanics and where the subscript ec indicates the scale of the particle oscillation in between the boundary conditions for the electron as the maximum  $R_e$  and the minimum  $r_{ps}$ .

Further quantum mechanical extension of the size of the atomic nucleus then defines the 1<sup>st</sup> Bohr radius and the size of the hydrogen atom in multiplying the Compton radius by alpha as  $r_{\text{Bohr1}} = R_e / \alpha^2 = 5.2171943 \times 10^{-11} \text{ m}^*$

The quantum mechanical nature of the atom, so becomes encompassed in the interaction of the classical electron with the electromagnetic finestructure and in allowing the spacial extent of the electron to oscillate within its classical definition of its electromagnetic self-interaction.

The temperature evolution of the universal cosmology so conformally relates this scale of the electron as a classical particle of spacetime, but as derivative of the Dirac monopole as its point particular representative to the macro-quantum form in the GFEH-googolplex.

**[Footnote 2]:**

KKK-Kernel mass=Up/Down-HiggsLevel=3x319.66 MeV\* = 958.99 MeV\*, using the Kernel-Ring and Family-Coupling Constants.

Subtracting the Ring-VPE (3L) gives the basic nucleonic K-State as 939.776 MeV\*. This excludes the electronic perturbation of the IR-OR oscillation.

For the Proton, one adds one (K-IR-Transition energy) and subtracts the electron-mass for the d-quark level and for the Neutron one doubles this to reflect the up-down-quark differential.

An electron perturbation subtracts one  $2-2/3=4/3$  electron energy as the difference between 2 leptonic rings from the proton's 2 up-quarks and  $2-1/3=5/3$  electron energy from the neutron' singular up-quark to relate the trisected nucleonic quark geometric template.

Proton  $m_p = u.d.u = K.KIR.K = (939.776 + 1.5013 - 0.5205 - 0.1735) \text{ MeV}^* = 940.5833 \text{ MeV}^* (938.270 \text{ MeV})$ .

Neutron  $m_n = d.u.d = KIR.K.KIR = (939.776 + 3.0026 - 1.0410 + 0.1735) \text{ MeV}^* = 941.9111 \text{ MeV}^* (939.594 \text{ MeV})$ . This is the ground state from the Higgs-Restmass-Induction-Mechanism and reflects the quarkian geometry as being responsible for the inertial mass differential between the two elementary nucleons.

All ground state elementary particle masses are computed from the Higgs-Scale and then become subject to various finestructures.

**[End of Footnote 2]**

The nuclear densities for neutron stars are defined in the ylemic vortices of the Gamow-Hawking protostars or Gamow-Hawking micro black holes in the function their temperatures. The temperature of the background universe so defines the temperature an electron- or neutron degenerate neutron star will have in its evolutionary development at a later stage of the cosmic temperature evolution.



The birth of population III stars as the earliest stars has been calculated to begin as the cores of galaxies as the cores of superclusters at a time marker defined in the superstring modulation of the wavelength of the instanton.

$1/r_{ss}=2\pi\lambda_{ss}=6.283\times 10^{22} \text{ m}^*$  and so the size of a large galaxy manifesting so 6.64 million years after the QBBS.

The Milky Way galaxy as one of the oldest galaxies in the cosmogenesis formed in the Sarkar regime of general galactic evolution and when the baryon mass seedling could manifest in the form of galaxies in the requirement for the Strominger extremal black hole evolution to have reached the Sarkar radius of 236.52 million light years.

This galactic displacement scale matches the time period for a revolution of the local star system to complete a cycle of rotation about the center of the Milky Way galaxy.

n-cycle coordinate and time	Radius as size of the universe	Modulation factor	Inversion Radius	Cosmological Redshift	Temperature	Hawking Radius Ylem Radius Hawking micro-BH mass	Cosmological Significance
$2nq_0=0.02803012$ 473.039 My	$R_{\text{sarkar}}=2G_0M_0/c^2=4.47830347 \times 10^{24}$	$1.62 \times 10^{20}$	$3.62044 \times 10^{-5}$	5.0152	30.570 K*	$7.3757 \times 10^{-5} \text{ m}^*$ $0.29071 \text{ m}^*$ $2.9871 \times 10^{22} \text{ kg}^*$	dark matter galaxies from supercluster seed manifest honey-comb universal geometry baryon seed $m_{\text{obaryon}}=0.02803=M_0/M_H=2\Lambda_0/A_{\text{dB}}$
$nq_0=0.01401506$ 236.520 My	$R_{\text{sarkar}}=G_0M_0/c^2=2.23915174 \times 10^{24}$	$4.05 \times 10^{19}$	$1.81022 \times 10^{-5}$	7.4777	51.062 K*	$4.4157 \times 10^{-5} \text{ m}^*$ $0.37572 \text{ m}^*$ $1.7884 \times 10^{22} \text{ kg}^*$	Quasar wall - 1 <sup>st</sup> protostars from supercluster seeds Deceleration parameter $q_0=\frac{1}{2}M_0/M_H=\Lambda_0/A_{\text{dB}}$
$\frac{1}{2}nq_0=0.00700753$ 118.260 My	$R_{\text{sarkar}}=\frac{1}{2}G_0M_0/c^2=1.11957587 \times 10^{24}$	$1.01 \times 10^{19}$	$9.0511 \times 10^{-6}$	10.967	85.578 K*	$2.6347 \times 10^{-5} \text{ m}^*$ $0.48641 \text{ m}^*$ $1.0671 \times 10^{22} \text{ kg}^*$	White Hole-Black Hole Sarkar modulation Birth of 1 <sup>st</sup> galaxies like the Milky Way form as baryon seed for dark matter galaxies protostars manifest from ylem white hole-black hole coupling
$3.93425 \times 10^{-4}$ 6.63948 My	$r_{ss}=2\pi\lambda_{ss}=6.283 \times 10^{22}$	$3.19 \times 10^{16}$	$5.07943 \times 10^{-7}$	49.421	358.05 K*	$6.2973 \times 10^{-6} \text{ m}^*$ $0.99494 \text{ m}^*$ $2.5504 \times 10^{21} \text{ kg}^*$	Modular wormhole perimeter White Hole upper limit as wormhole sourcesink $E_{\text{ps}}$ begins to activate as black hole power sourcesink $E_{\text{ss}}$ dark matter galaxies geometry

The time period from 16 seconds to 21 minutes in the evolution of the universe encompasses a time for the Hawking micro black holes increasing in mass from  $1.7 \times 10^{11} \text{ kg}^*$  to  $1.0 \times 10^{14} \text{ kg}^*$  corresponding to their temperatures decreasing from  $5.10 \times 10^{12} \text{ K}^*$  to  $8.82 \times 10^9 \text{ K}^*$ .

Setting the nuclear density as  $\rho_{\text{nuclearOR}}=3m_c/4\pi R_e^3=3k_B T_{\text{Hawking}}/4\pi G_0 m_c R_{\text{ylem}}^2 = 1.10545 \times 10^{16} [\text{kg}/\text{m}^3]^*$  then calculates the density of a neutron star exhibiting electron degeneracy at the temperature regimes given by the ylem radius.

As in this formulation the gravitational parameter is partitioned in:

$G_0 m_c^2 = \text{constant} = G(n) X^n M(n) Y^n = G(n) X^n m_c Y^u m_c Y^v =$  for superscripts  $u+v=n$  for  $(XY)^n=1$ , the mass evolution for the primordial nucleon  $m_c = m_{\text{plank}} \alpha^9 = 9.92472459 \times 10^{-28} \text{ kg}^*$  must be considered. For the present time, the  $m_c$  primordial nucleon has attained the scale of the measured neutron mass in  $m_c Y^{\text{npresent}} = 1.711753 \times 10^{-27} \text{ kg}^*$  or  $1.7053526 \times 10^{-27} \text{ kg}_{\text{SI}}$ .

As the leptonic ring masses are integrated into the quarkian kernel masses, the measured masses for the electron, muon and tauon remain constant subject to their energy variation in the Compton constant  $m_e R_e = h\alpha / 2\pi c$ .

Then, the nuclear densities calculated in the initial period of the cosmology will increase at later times as the effect of the mass evolution of the universe, transmuted Vortex-Potential Energy (VPE) as the UniPhysCon 'physicalized consciousness energy' of the original source energy for the creation event.

The leptonic outer ring (OR) for the electron degeneracy then defines the nuclear densities for electron degenerate neutron stars being born as the from the spacetime vortices defined by Hawking-Gamow micro black holes.

The mesonic inner ring inner (IR) reduces the scale of the classical electron radius by a factor of 1000 and defines the Higgs boson at that scale as the progeny of the RMP separated from the electron base scale in a factor of 100,000 as the dark matter particle of the cosmogenesis.

The mesonic inner ring defines the neutron degeneracy for quark or proton stars coupled to the primordial neutron decay given in the inversion scale for the radial size of the universe as defined in the googolplex E-FGF' in modular membrane mirror duality with the classical electron scale.

As the strange wave quark is a resonance of the down wave quark in the oscillation potential between the kernel up wave quark K and the outer ring OR for the Compton constant and the energy scale for the classical electron; the neutron degeneracy is given in the entire range from the gluon-neutrino kernel of the QBBS-Dirac monopole singularity to the inner bound of the dark matter particle RMP at the  $10^{-5}$  fermi scale.

For electron degeneracy characteristic neutron star radii are in the range of the Compton radius  $R_e/\alpha$  to its modulation in  $R_e/2\pi\alpha$  to the modulated electron radius  $2\pi R_e$  as Hawking radii for micro black holes for temperatures from  $5.92 \times 10^9 \text{ K}^*$  to  $3.72 \times 10^{10} \text{ K}^*$  to  $1.29 \times 10^{11} \text{ K}^*$ .

Typical neutron star radii as ylem radii range from 4,045.5 m\* to 10,143.3 m\* to 18,899.0 m\* for respective neutron star masses from  $1.64 \times 10^{30} \text{ kg}$  as 0.819  $M_{\text{sun}}$  to  $4.11 \times 10^{30} \text{ kg}^*$  as 2.05  $M_{\text{sun}}$  to  $7.65 \times 10^{30} \text{ kg}^*$  as 3.83  $M_{\text{sun}}$  respectively.

The Chandrasekhar limit for white dwarves is approximated by the mass quantization  $M = \sum m_{ss} = \sum hf_{ss}/c^2$  and modulation  $M/\sum m_{ss} = h/m_{ss}c^2 = hf_{ps}/h = f_{ps} |_{\text{mod}} = 3 \times 10^{30}$  as 1.50  $M_{\text{sun}}$  for a temperature of  $1.98 \times 10^{10} \text{ K}^*$  for a Hawking black hole micro-mass of  $4.60 \times 10^{13} \text{ kg}^*$  and a Gamow-Hawking ylem radius of 7,407.7 m\*

The charge radius of the proton is calculated as proportional to the classical electron radius as  $\frac{1}{2} X R_e = 0.8583806 \times 10^{-15} \text{ m}^*$  reduced from  $\frac{1}{2} R_e = 1.388889 \times 10^{-15} \text{ m}^*$  and reduced from  $X R_e = 1.7167606 \times 10^{-15} \text{ m}^*$  as Hawking radii for the micro black holes for respective electron masses of  $3.0064778 \times 10^{-30} \text{ kg}^*$  and  $1.858105 \times 10^{-30} \text{ kg}^*$  and  $1.50324 \times 10^{-30} \text{ kg}^*$ .

The nuclear densities for neutron degeneracy with increasing pressure from the surface density to the core density then calculate for respective Hawking radii for the micro black holes as:

$\rho_{\text{nuclearOR}} = 3m_c / 4\pi R_e^3 = 3k_B T_{\text{Hawking}} / 4\pi G_0 m_c R_{\text{ylem}}^2 = 1.105 \times 10^{16} \text{ [kg/m}^3\text{]}^*$  for a temperature  $8.117 \times 10^{11} \text{ K}^*$  and ylem mass  $1.92 \times 10^{31} \text{ kg}^*$  as  $9.60 M_{\text{sun}}$

$\rho_{\text{nuclearX}} = 3m_c Y^3 / 4\pi R_e^3 = 3Y^3 k_B T_{\text{Hawking}} / 4\pi G_0 m_c R_{\text{ylem}}^2 = 4.683 \times 10^{16} \text{ [kg/m}^3\text{]}^*$  for a temperature  $1.313 \times 10^{12} \text{ K}^*$  and ylem mass  $2.44 \times 10^{31} \text{ kg}^*$  as  $12.20 M_{\text{sun}}$

$\rho_{\text{nuclear}\frac{1}{2}} = 24m_c / 4\pi R_e^3 = 24k_B T_{\text{Hawking}} / 4\pi G_0 m_c R_{\text{ylem}}^2 = 8.844 \times 10^{16} \text{ [kg/m}^3\text{]}^*$  for a temperature  $1.623 \times 10^{12} \text{ K}^*$  and ylem mass  $2.71 \times 10^{31} \text{ kg}^*$  as  $13.57 M_{\text{sun}}$

$\rho_{\text{nuclear}\frac{1}{4}} = 24m_c Y^3 / 4\pi R_e^3 = 24Y^3 k_B T_{\text{Hawking}} / 4\pi G_0 m_c R_{\text{ylem}}^2 = 3.746 \times 10^{17} \text{ [kg/m}^3\text{]}^*$  for a temperature  $2.627 \times 10^{12} \text{ K}^*$  and ylem mass  $3.45 \times 10^{31} \text{ kg}^*$  as  $17.26 M_{\text{sun}}$

n-cycle coordinate and time	Radius as size of the universe	Modulation factor	Inversion Radius	Cosmological Redshift	Temperature	Hawking/Ylem Radius micro-BH mass	Cosmological Significance
2.45458x10 <sup>-13</sup> 1.5130 days	3.92162x10 <sup>13</sup>	0.0124	3.17040x10 <sup>-16</sup>	2.0184x10 <sup>6</sup>	5.9229x10 <sup>9</sup> K*	3.80686x10 <sup>-13</sup> m* 4,045.503 m* 1.5418x10 <sup>14</sup> kg*	R <sub>Hawking</sub> =R <sub>e</sub> /α=Compton radius Electron degeneracy surface for neutron stars R <sub>ylem</sub> =R <sub>curv</sub> for M <sub>ylem</sub> =1.64x10 <sup>30</sup> kg*/0.819M <sub>sun</sub>
1.44329x10 <sup>-13</sup> 76,863.6 s* 21.35 hours	2.30591x10 <sup>13</sup>	4.299x10 <sup>-3</sup>	1.86419x10 <sup>-16</sup>	2.6322x10 <sup>6</sup>	8.8207x10 <sup>9</sup> K*	2.5562x10 <sup>-13</sup> m* 4,938.271 m* 1.0353x10 <sup>14</sup> kg*	R <sub>ylem</sub> =R <sub>curv</sub> for M <sub>ylem</sub> =2.00x10 <sup>30</sup> kg*/1.000M <sub>sun</sub>
4.89513x10 <sup>-14</sup> 26,069.4 s* 7.24 hours	7.82083x10 <sup>12</sup>	4.945x10 <sup>-4</sup>	6.32267x10 <sup>-17</sup>	4.5198x10 <sup>6</sup>	1.9847x10 <sup>10</sup> K*	1.1361x10 <sup>-13</sup> m* 7,407.407 m* 4.6011x10 <sup>13</sup> kg*	Nuclear density ρ <sub>nuc</sub> =3m <sub>e</sub> Y <sup>3</sup> /4π{R <sub>e</sub> } <sup>3</sup> (1.105-1.907)x10 <sup>16</sup> [kg/m <sup>3</sup> ]* R <sub>ylem</sub> =√{3k <sub>B</sub> T/4πG <sub>0</sub> m <sub>c</sub> ρ <sub>nuc</sub> } for 1.5 M <sub>sun</sub> M=Σm <sub>ss</sub> =Σhf <sub>ss</sub> /c <sup>2</sup> mass quantization for space quanta count M/Σm <sub>ss</sub> =h/m <sub>ss</sub> c <sup>2</sup> =hf <sub>ps</sub> /h=f <sub>ps</sub>   <sub>mod</sub> =3x10 <sup>30</sup> as 1.50 M <sub>sun</sub>
2.11706x10 <sup>-14</sup> 11,274.5 s* 3.132 hours	3.38237x10 <sup>12</sup>	9249x10 <sup>-5</sup>	2.73445x10 <sup>-17</sup>	6.8728x10 <sup>6</sup>	3.7215x10 <sup>10</sup> K*	6.05875x10 <sup>-14</sup> m* 10,143.34 m* 2.4538x10 <sup>13</sup> kg*	R <sub>Hawking</sub> =R <sub>e</sub> /2πα = Compton radius Ess modulation Electron degeneracy core for neutron stars R <sub>ylem</sub> =R <sub>curv</sub> for M <sub>ylem</sub> =4.11x10 <sup>30</sup> kg*/2.054M <sub>sun</sub>

4.02765x 10 <sup>-15</sup> 2144.96 s* 32.749 min	6.43488x10 <sup>11</sup>	3.348x1 0 <sup>-6</sup>	5.20221x10 <sup>-18</sup>	1.5757x1 0 <sup>7</sup>	1.2919x10 <sup>11</sup> K*	1.7453x1 0 <sup>-14</sup> m* 18,899.00 m* 7.0686x1 0 <sup>12</sup> kg*	R <sub>Hawking</sub> =2πR <sub>e</sub> R <sub>ylem</sub> =R <sub>curv</sub> for M <sub>ylem</sub> =7.65x10 <sup>30</sup> kg*/3.827M <sub>sun</sub>
2.160062 x10 <sup>-15</sup> 1150.36 s* 19.173 min	R <sub>F</sub> = $\sqrt[3]{F}(\lambda_{weyl}/2\pi)=3.45107$ 750x10 <sup>11</sup>	9.6x10 <sup>-7</sup>	R <sub>F</sub> =2.789990x10 <sup>-18</sup>	2.15163x 10 <sup>7</sup>	2.0614x10 <sup>11</sup> K*	1.0938x1 0 <sup>-14</sup> m* 23,872.87 m* 4.4299x1 0 <sup>12</sup> kg*	R <sub>ylem</sub> =R <sub>curv</sub> for M <sub>ylem</sub> =9.67x10 <sup>30</sup> kg*/4.834M <sub>sun</sub>
2.122808 x10 <sup>-15</sup> 1130.52 s* 18.8420 min	R <sub>G</sub> = $\sqrt[3]{G}(\lambda_{weyl}/2\pi)=3.3915$ 5801x10 <sup>11</sup>	9.3x10 <sup>-7</sup>	R <sub>G</sub> =2.741872x10 <sup>-18</sup>	2.17042x 10 <sup>7</sup>	2.0885x10 <sup>11</sup> K*	1.0796x1 0 <sup>-14</sup> m* 24,029.28 m* 4.3724x1 0 <sup>12</sup> kg*	R <sub>ylem</sub> =R <sub>curv</sub> for M <sub>ylem</sub> =9.73x10 <sup>30</sup> kg*/4.866M <sub>sun</sub>
2.084198 x10 <sup>-15</sup> 1109.96 s* 18.499 min	R <sub>F</sub> = $\sqrt[3]{F}(\lambda_{weyl}/2\pi)=3.3298$ 7275x10 <sup>11</sup>	9.0x10 <sup>-7</sup>	R <sub>F</sub> =2.69200x10 <sup>-18</sup>	2.19044x 10 <sup>7</sup>	2.1175x10 <sup>11</sup> K*	1.0648x1 0 <sup>-14</sup> m* 24,195.54 m* 4.3125x1 0 <sup>12</sup> kg*	Primordial neutron decay: λ <sub>F</sub> -2πλ <sub>RMP</sub> (1109.96-229.82) s* = 880.14 s*/879.28 s from Higgs Boson with RMP template R <sub>ylem</sub> =R <sub>curv</sub> for M <sub>ylem</sub> =9.80x10 <sup>30</sup> kg*/4.900M <sub>sun</sub>
8.75370x 10 <sup>-16</sup> 466.186 s* 7.770 min	1.39856x10 <sup>11</sup>	1.6x10 <sup>-7</sup>	1.13065x10 <sup>-18</sup>	3.89284x 10 <sup>7</sup>	4.05858x10 <sup>11</sup> K*	5.55556x 10 <sup>-15</sup> m* 33,497.33 m* 2.2500x1 0 <sup>12</sup> kg*	R <sub>Hawking</sub> =2R <sub>e</sub> R <sub>ylem</sub> =R <sub>curv</sub> for M <sub>ylem</sub> =1.3566x10 <sup>31</sup> kg*/6.78M <sub>sun</sub>
4.315415 x10 <sup>-16</sup> 229.821 s* 3.8304 min	R <sub>neutrondecay</sub> =6.8946323x1 0 <sup>10</sup>	3.8x10 <sup>-8</sup>	2πλ <sub>RMP</sub> =4π <sup>2</sup> R <sub>RMP</sub> =5.573 89763x10 <sup>-19</sup>	4.81381x 10 <sup>7</sup>	6.89874x10 <sup>11</sup> K* M <sub>Hawking</sub> =2.79 2x10 <sup>37</sup> T <sub>Hawking</sub> =3.270 3x10 <sup>-14</sup>	3.2684x1 0 <sup>-15</sup> m* 43,672.54 m* 1.3237x1 0 <sup>12</sup> kg*	Beginning of neutron decay from Higgs Boson with RMP template R <sub>ylem</sub> =R <sub>curv</sub> for M <sub>ylem</sub> =1.77x10 <sup>31</sup> kg*/8.844M <sub>sun</sub>
3.473914 x10 <sup>-16</sup> 185.006 s* 3.083 min	5.550187x10 <sup>10</sup>	2.5x10 <sup>-8</sup>	4.486994x10 <sup>-19</sup>	5.36526x 10 <sup>7</sup>	8.11715x10 <sup>11</sup> K*	2.7778x1 0 <sup>-15</sup> m* 47,372.40 m* 1.1250x1 0 <sup>12</sup> kg*	R <sub>Hawking</sub> =R <sub>e</sub> Nuclear density ρ <sub>nuc</sub> =3m <sub>c</sub> Y <sup>n</sup> /4π{R <sub>e</sub> } <sup>3</sup> (1.105-1.907)x10 <sup>16</sup> [kg/m <sup>3</sup> ]* R <sub>ylem</sub> =R <sub>curv</sub> for M <sub>ylem</sub> =1.92x10 <sup>31</sup> kg*/9.593M <sub>sun</sub>
1.828887 x10 <sup>-16</sup> 97.398 s* 1.623 min	2.921968x10 <sup>10</sup>	6.9x10 <sup>-9</sup>	2.362236x10 <sup>-19</sup>	7.39446x 10 <sup>7</sup>	1.3134x10 <sup>12</sup> K*	1.7168x1 0 <sup>-15</sup> m* 60,257.94 m* 6.9529x1 0 <sup>11</sup> kg*	R <sub>Hawking</sub> =XR <sub>e</sub> =Protonic diameter Nuclear density ρ <sub>nuc</sub> =3m <sub>c</sub> Y <sup>n</sup> /4π{XR <sub>e</sub> } <sup>3</sup> (4.683-8.077)x10 <sup>16</sup> [kg/m <sup>3</sup> ]* R <sub>ylem</sub> =R <sub>curv</sub> for M <sub>ylem</sub> =2.44x10 <sup>31</sup> kg*/12.202M <sub>sun</sub>

1.378658 $\times 10^{-16}$ 73.422 s* 1.224 min	2.202648 $\times 10^{10}$	3.9 $\times 10^{-9}$	1.780709 $\times 10^{-19}$	8.51671 $\times 10^7$	1.6234 $\times 10^{12}$ K*	1.3889 $\times 10^{-15}$ m* 66,994.07 m* 5.6250 $\times 10^{11}$ kg*	$R_{\text{Hawking}} = \frac{1}{2}R_e$ Nuclear density $\rho_{\text{nuc}} = 3m_e \gamma^n / 4\pi \{ \frac{1}{2}R_e \}^3$ (8.844-15.253) $\times 10^{16}$ [kg/m <sup>3</sup> ]* $R_{\text{ylem}} = R_{\text{curv}}$ for $M_{\text{ylem}} = 2.71 \times 10^{31}$ kg* / 13.566 $M_{\text{sun}}$
7.257512 $\times 10^{-17}$ 38.650 s*	1.159515 $\times 10^{10}$	1.1 $\times 10^{-9}$	9.37398 $\times 10^{-20}$	1.17383 $\times 10^8$	2.6268 $\times 10^{12}$ K*	8.5838 $\times 10^{-16}$ m* 85,218.27 m* 3.4764 $\times 10^{11}$ kg*	$R_{\text{Hawking}} = \frac{1}{2}XR_e$ Nuclear density $\rho_{\text{nuc}} = 3m_e \gamma^n / 4\pi \{ \frac{1}{2}XR_e \}^3$ (3.746-6.461) $\times 10^{17}$ [kg/m <sup>3</sup> ]* $R_{\text{ylem}} = R_{\text{curv}}$ for $M_{\text{ylem}} = 3.45 \times 10^{31}$ kg* / 17.257 $M_{\text{sun}}$
2.9962 $\times 10^{-17}$ 15.957 s*	4.78696 $\times 10^9$	1.9 $\times 10^{-10}$	3.86997 $\times 10^{-20}$	1.82690 $\times 10^8$	5.1002 $\times 10^{12}$ K*	4.42097 $\times 10^{-16}$ m* 118,744.5 6 m* 1.7905 $\times 10^{11}$ kg*	$R_{\text{Hawking}} = R_e / 2\pi$ Ess modulation Neutron degeneracy $R_{\text{ylem}} = R_{\text{curv}}$ for $M_{\text{ylem}} = 4.81 \times 10^{31}$ kg* / 24.05 $M_{\text{sun}}$



## TYPE I SUPERNOVAE:

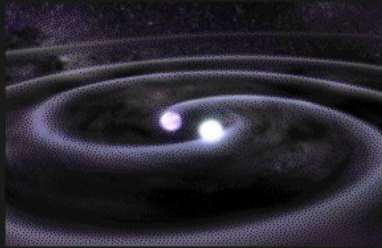

This type of nova takes place in binary star systems, with one of the stars classified as a white dwarf.

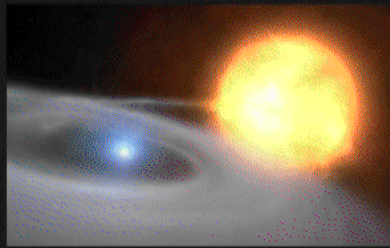

The dwarf accretes material from its larger counterpart, accumulating mass as a result. This eventually incites a chain nuclear reaction..

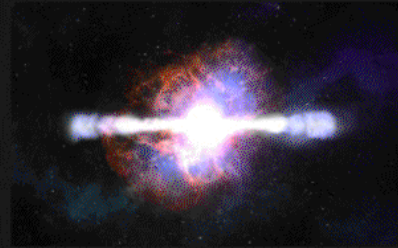

culminating in the star reaching critical density, when it explodes in a supernova. Beams of gamma radiation can also be emitted.

## TYPE II SUPERNOVAE:

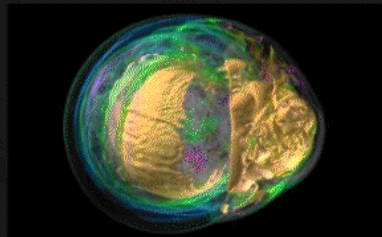

After losing the ability to stably fuse heavy elements, the star can no longer retain a gravitational equilibrium, thus the core collapses in on itself.

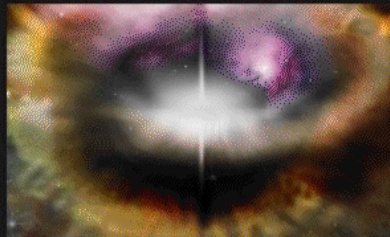

The core rebounds in quick succession, subsequently releasing the outerlayers of gas off into space — forming a nebula.

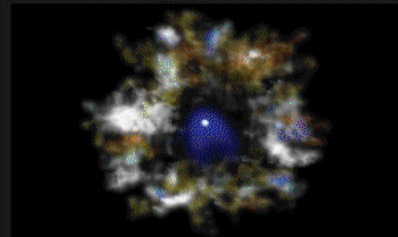

After the dust settles, a neutron star or black hole is left behind (which one will hinge on the star's mass)

Image Credits (Clockwise, from top to bottom): Tod Strohmayr & Dana Berry, Celojums Kosmosa (Vimeo), NASA/Dana Berry/Skyworks Digital, NASA (taken by Chandra), 'Daftopia' (Deviant Art), Argonne National Laboratory/Hongfeng Yu. (Infographic by' From Quarks to Quasars')

How can you be certain that  
your whole life is not a dream?

René Descartes

quandary

## X: Primordial Neutron Decay from Higgs Boson – RMP/DM Quantum Geometry

### The Higgs boson with a scalar Higgs scalar neutrino in the conformal mapping of the QBBS onto the cosmology

As the universe reached an age between 1130-1150 seconds, a 20 second period from the 18 minute 50 second marker manifested primordial radioactive beta-minus decay in the decomposition of a lefthanded ylemic neutron into its constituent parts of a lefthanded proton with a lefthanded electron and a righthanded antineutrino.

As this process is a weak nuclear interaction (WNI) a coupling to the strong nuclear interaction (SNI) was made manifest in the ylemic neutron star's core transforming the quark content of the ylemic neutron in the interaction with gluons and crystallizing the force carrying bosons for the WNI and the SNI as weakon bosons ( $W^-$  for matter and  $W^+$  for antimatter and  $Z^0$  for uncharged matter) and gluons, respectively.

Neutron decay depends on the relative movement of the neutron with respect to their environment. The measured discrepancy in the mean lifetime of free neutrons of about 9 seconds using either a 'proton trap bottle' or a 'proton beam' counter of 879 and 888 seconds respectively, so engages the definition of the RMP as being coupled to the Higgs Boson in the matter template YCM.

Higgs Boson  $72.93Y^{np}=125.78 \text{ GeV}^*/125.48 \text{ GeV}$  with RMP dark matter excess= $126.95/125.78=1.0093$  for Mean  $\Delta \text{ time } \frac{1}{2}(G-F)=10.28 \text{ s}^*$

Higgs Boson  $71.020Y^{np}=122.49 \text{ GeV}^*/122.19 \text{ GeV}$  with RMP -dark matter deficit= $122.49/123.57=0.9913$  for Mean  $\Delta \text{ time } \frac{1}{2}(F-G)=9.92 \text{ s}^*$

$\frac{1}{2}(F-G)={1150.36-1130.52}=9.92$  seconds for the dark matter/RMP deficit in the stated 20 second period for the primordial neutron decay as  ${1109.96-229.82}=880.14$  seconds  $\frac{1}{2}(G-F)={1130.52-1109.96}=10.28$  seconds for the dark matter/RMP excess in the stated 20 second period for the primordial neutron decay as  ${1109.96-229.82}=880.14$  seconds

The decoupling of the RMP from the Higgs Boson introduced the colourless Graviton as the spin conserver in the UfoQR to preserve the spin neutrality of the Higgs Boson in the lefthanded RMP with the righthanded Graviton.

The RMP is the dark matter particle in the Higgs field and is defined in the units of the gravitational parameter as a space quanta volumar acted upon by the time differential of frequency  $df/dt$  as a form of quantum spin angular acceleration.

The primordial neutron decay in the first 20 minutes of the QBBS universe became triggered in the initial boundary conditions defined in the space quanta counters E, F and G, with the manifestation of the Dirac monopole singularity as the wavelength  $\lambda^*=c/f^*=4.087933536 \times 10^{14} \text{ m}^*$  for radius  $R^*=\lambda^*/2\pi =R(n^*=H_0 t^{**}=4.072259032 \times 10^{-13}) =6.506148293 \times 10^{13} \text{ m}^*$  for a time  $t^{**}=216,871.61 \text{ s}^*$  or 2.51 mean solar days into the expansion and thermodynamic evolution of the universe.

The Riemann hyperspheres of the instanton-inflaton evolutionary light path correspond to the quantum geometry inherent in the QBBS.

$R_E = \sqrt[3]{E}(\lambda_{\text{weyl}}/2\pi) = 3.43597108 \times 10^{14} \text{ m}^*$  for a time

$t_E = n_E/H_0 = 2.1506 \times 10^{-12}/H_0 = 1,145,323.7 \text{ s}^*$  or 318.145 hours

and a temperature  $T_E = 1.163 \times 10^9 \text{ K}^*$  from  $T(n) = \sqrt[4]{\{H_0^3 M_0 / 1100 \pi^2 \sigma_{\text{SB}}\} \cdot \{(n+1)^2 / n^3\}}$  corresponds to  $R_e = 2.7777 \times 10^{-15} \text{ m}^*$  in the ratio  $R_e/R_E = 8.0844 \times 10^{-30}$

$R_F = \sqrt[3]{F}(\lambda_{\text{weyl}}/2\pi) = 3.45107750 \times 10^{11} \text{ m}^*$  for a time  $t_F = n_F/H_0 = 2.1601 \times 10^{-15}/H_0 = 1150.36 \text{ s}^*$  or 19.17 minutes and a temperature  $T_E = 2.0614 \times 10^{11} \text{ K}^*$  corresponds to  $R_{\text{HBlower}} = R_e \{R_F/R_E\} = 2.789990 \times 10^{-18} \text{ m}^*$  in the upper bound for the Higgs Boson HB

for a Compton mass  $m_{\text{HBlower}} = h/(2\pi c R_{\text{HBlower}}) = 1.26766 \times 10^{-25} \text{ kg}^*$  or 71.020 GeV\* increasing to  $71.020(Y^{np}) = 122.491 \text{ GeV}^*$  for  $n_p = 1.132712$

$R_G = \sqrt[3]{G}(\lambda_{\text{weyl}}/2\pi) = 3.39155801 \times 10^{11} \text{ m}^*$  for a time

$t_G = n_G/H_0 = 2.1228 \times 10^{-15}/H_0 = 1130.52 \text{ s}^*$  or 18.84 minutes and a temperature  $T_E = 2.0885 \times 10^{11} \text{ K}^*$  corresponds to  $R_{\text{HBmean}} = R_e \{R_G/R_E\} = 2.741872 \times 10^{-18} \text{ m}^*$  in the mean mirror value for the Higgs Boson

for a Compton mass  $m_{\text{HBmean}} = h/(2\pi c R_{\text{HBmean}}) = 1.28991 \times 10^{-25} \text{ kg}^*$  or 72.266 GeV\* increasing to  $72.266(Y^{np}) = 124.640 \text{ GeV}^*$  for  $n_p = 1.132712$

For  $F' = (2G - F) = 9.158461354 \times 10^{102}$  space quanta =  $R_{F'} = \sqrt[3]{F'}(\lambda_{\text{weyl}}/2\pi) = 3.32987275 \times 10^{11} \text{ m}^*$  for a time

$t_{F'} = n_{F'}/H_0 = 2.0842 \times 10^{-15}/H_0 = 1109.96 \text{ s}^*$  or 18.50 minutes

and a temperature  $T_E = 2.1173 \times 10^{11} \text{ K}^*$  corresponds to  $R_{\text{HBlower}} = R_e \{R_{F'}/R_E\} = 2.6920000 \times 10^{-18} \text{ m}^*$  in the lower bound for the Higgs Boson

for a Compton mass  $m_{\text{HBupper}} = h/(2\pi c R_{\text{HBupper}}) = 1.31381 \times 10^{-25} \text{ Kg}^*$  or 73.605 GeV\* increasing to  $73.605(Y^{np}) = 126.950 \text{ GeV}^*$  for  $n_p = 1.132712$

increasing to  $73.605(Y^{np}) = 126.950 \text{ GeV}^*$  for  $n_p = 1.132712$

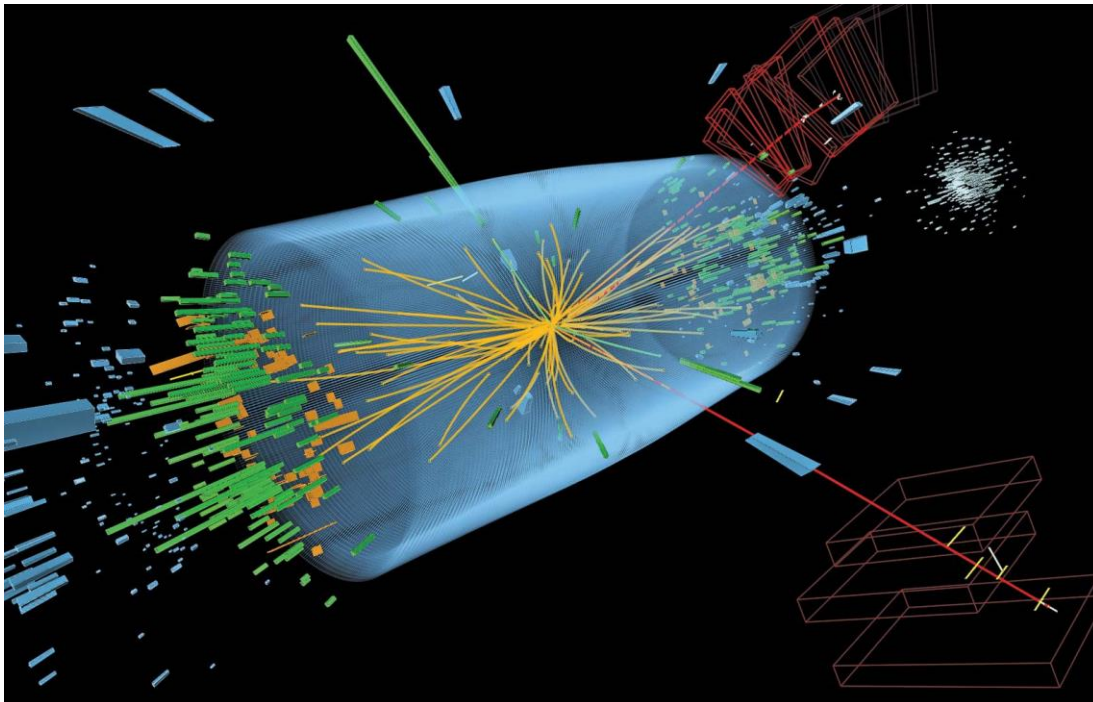



Higgs-Bosonic template for a Calabi-Yau wavequark proton KIR.K.KIR - u.d.u

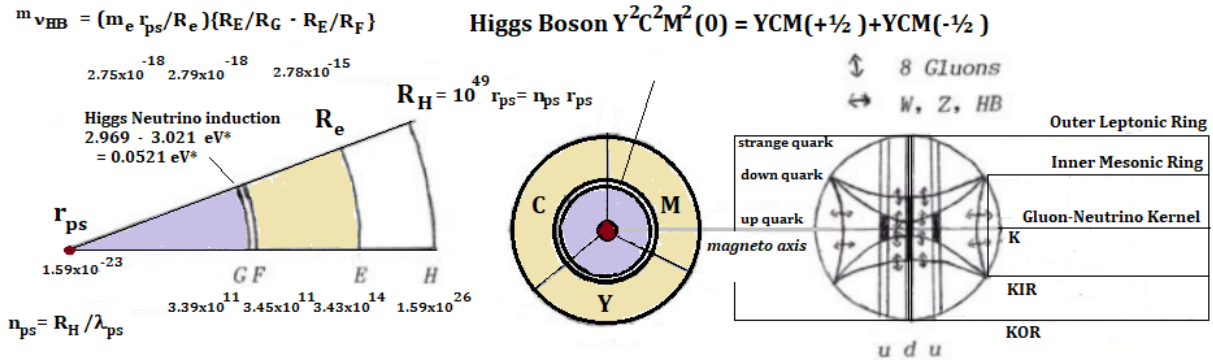

The eight gluonic permutation states are the set: {WWW-WWB-WBW-BWW-BBW-BWB-WBB-BBB} between the radiative Eps-gauge photon self-state and the massive Ess-gauge anti-photon self-state.

The proton is stable as the  $M_0/m_c$  restmass seedling coupled to the electronic mass-quantum  $m_e$  via the XL-Boson superstring of unification gauge SEW.G of the H0(32) superstring class, manifesting via the hadron-mesonic X-Boson and the leptonic L-Boson at X-Boson time of  $t = 2.20 \times 10^{-39} \text{ s}^*$ , an effective temperature of  $2.145 \times 10^{28} \text{ K}^*$  and an effective post-Planck radius of  $1.051 \times 10^{-31} \text{ m}^*$  for a mass of  $3.36 \times 10^{-12} \text{ kg}^*$  or  $1.88 \times 10^{15} \text{ GeV}^*$

The Higgs Bosonic radius  $r_{HB}$  has a Compton-de Broglie mass at the Neutrino induction marker G for  $m_{HB} = h/2\pi c r_{HB} = 1.279 \times 10^{-25} \text{ kg}^*$  or  $71.636 \text{ GeV}^*$  at time  $t_g = 1130 \text{ s}^*$  increasing to  $m_{HB}^{np} = 2.206 \times 10^{-25} \text{ kg}^*$  or

$123.55 \text{ GeV}^*$  or  $123.09 \text{ GeV}$  as a mean value between markers F at  $1150 \text{ s}^*$  and F' at  $1110 \text{ s}^*$  for a Higgs Boson mass interval  $m_{HB} : \{1.268-1.290-1.314\} \times 10^{-25} \text{ kg}^*$  or  $\{71.02-72.27-73.61\} \text{ GeV}^*$  increasing to  $\{122.49-124.64-126.95\} \text{ GeV}^*$

for a present cycle time coordinate of  $n_p = 1.132711...$  for an EMMI age of the universe of 19.12 Gy

# HIGGS BOSON

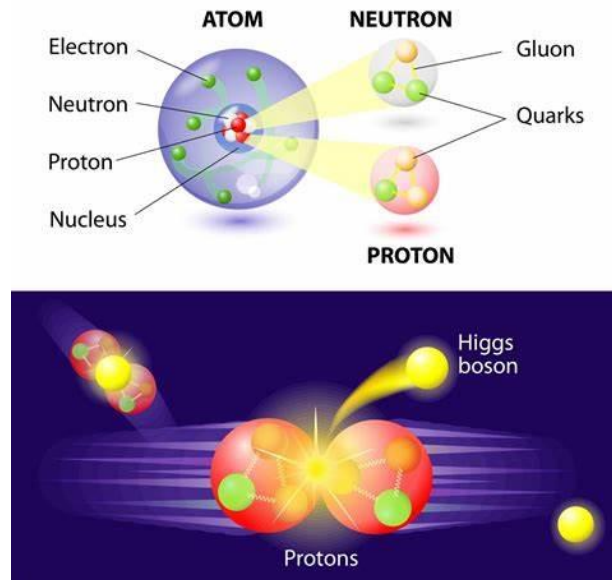

The Universal Temperature Evolution in light paths EMI and EMMI

$n=H,t$ $t_e$	Radius $m^*$ $R(n)=R_0/(n/(n+1))$	Mod factor	Quantum Modulation $E=hc/\lambda$	Cosmological comoving redshift $z+1=(1+z/n)/(n+2)$ Energy $J^*/GeV^*$	Temperature CBBR $T = \sqrt[3]{(18.2(n+1)/n^3)}$ of cycle time $n$ $T_{Hawking}/T_{Planck} = 1 = hcR_0^2/2\pi G_0 m^2 R_{Hawking} R_{Hawking}$ Boson Energy $E=K T$	Hawking $\mu$ h Radius Ylem Radius Hawking Mass	Hawking Temp $T_{Hawking}=hc^2/4\pi k_B G_0 M_{Hawking}$ Ylem Radius $R_{Ylem}=\sqrt{(k_B T R_0^2)/G_0 m^2}$ Hawking Radius $R_{Hawking}=hc/2\pi k_B T_{Hawking}$ Hawking Mass $M_{Hawking}=R_{Hawking} c^2/2G_0$
2.767x10 <sup>-42</sup> 1.474x10 <sup>-24</sup>	$R_0/2\pi = R_0/2\pi = 4.42097x10^{-16}$	$R_0 R_0/4\pi^2$ 0.0242	$R_0/2\pi = 5.468517817x10^{11}$	6.01x10 <sup>10</sup> 4.524x10 <sup>-10</sup> J* 2.816 GeV*	3.0445x10 <sup>11</sup> K*	-	
1.746x10 <sup>-44</sup> 9.300x10 <sup>-27</sup>	$\lambda_p=(R_0/R_0)R_0=2.789990x10^{-18}$ $r_p=4.4404070x10^{-19}$	9.63x10 <sup>-7</sup>	$R_0=\sqrt[3]{F(\lambda_{avg}/2\pi)}$ $=3.45107750x10^{11}$ 1150.36 s*	7.57x10 <sup>11</sup> (7.168-1.141)x10 <sup>8</sup> J* (446.23-71.02) GeV*	1.3598x10 <sup>11</sup> K*	-	Higgs Boson 71.020 <sup>99</sup> =122.49 GeV* 122.19 GeV RMP -dark matter deficit=122.49/123.57=0.9913
1.731x10 <sup>-44</sup> 9.220x10 <sup>-27</sup>	2.7659325x10 <sup>-18</sup> 4.4021183x10 <sup>-19</sup>	9.46x10 <sup>-7</sup>	3.42132x10 <sup>11</sup> 1140.44 s*	7.60x10 <sup>11</sup> (7.231-1.151)x10 <sup>8</sup> J* (450.11-71.64) GeV*	1.3687x10 <sup>11</sup> K*	-	Higgs Boson 71.64 <sup>99</sup> =123.56 GeV* 123.25 GeV Mean $\Delta$ time $\% (F-G)=9.92 s^*$
1.716x10 <sup>-44</sup> 9.140x10 <sup>-27</sup>	$\lambda_p=(R_0/R_0)R_0=2.741872x10^{-18}$ $r_p=4.36382482x10^{-19}$	9.30x10 <sup>-7</sup>	$R_0=\sqrt[3]{G(\lambda_{avg}/2\pi)}$ $=3.39155801x10^{11}$ 1130.52 s*	7.63x10 <sup>11</sup> (7.294-1.161)x10 <sup>8</sup> J* (454.06-72.266) GeV*	1.3776x10 <sup>11</sup> K*	-	Higgs Boson 72.266 <sup>99</sup> =124.64 GeV* 124.33 GeV Higgs neutrino: $m_{\nu_e}=m_{\nu_\mu}(R_0/R_0-R_0/R_0)/R_0=9.305x10^{-34} kg^*$ 0.052 eV* neutrino mass induction 2.969-3.021 eV*
1.702x10 <sup>-44</sup> 9.065x10 <sup>-27</sup>	2.719631x10 <sup>-18</sup> 4.3284271x10 <sup>-19</sup>	9.14x10 <sup>-7</sup>	3.364047x10 <sup>11</sup> 1121.35 s*	7.665x10 <sup>11</sup> (7.354-1.170)x10 <sup>8</sup> J* (457.77-72.857) GeV*	1.3861x10 <sup>11</sup> K*	-	125.66 GeV* 125.35 GeV 1 eV* = 0.997540464 eV <sub>SI</sub> 1 s* = 0.999022562 s <sub>SI</sub> 1 kg* = 0.996260907 kg <sub>SI</sub>
1.701x10 <sup>-44</sup> 9.057x10 <sup>-27</sup>	2.716941x10 <sup>-18</sup> 4.324146x10 <sup>-19</sup>	9.06x10 <sup>-7</sup>	3.336072x10 <sup>11</sup> 1120.24 s*	7.668x10 <sup>11</sup> (7.361-1.172)x10 <sup>8</sup> J* (458.23-72.93) GeV*	1.3870x10 <sup>11</sup> K*	-	Higgs Boson 72.93 <sup>99</sup> =125.78 GeV* 125.48 GeV RMP -dark matter excess=126.95/125.78=1.0093 Mean $\Delta$ time $\% (G-F)=10.28 s^*$
1.685x10 <sup>-44</sup> 8.973x10 <sup>-27</sup>	$\lambda_p=(R_0/R_0)R_0=2.69200x10^{-18}$ $r_p=4.4404070x10^{-19}$	8.96x10 <sup>-7</sup>	$R_0=\sqrt[3]{F^2(\lambda_{avg}/2\pi)}$ $=3.32987275x10^{11}$ 1109.96 s*	7.70x10 <sup>11</sup> (7.429-1.182)x10 <sup>8</sup> J* (462.47-73.605) GeV*	1.3966x10 <sup>11</sup> K*	-	Higgs Boson 73.605 <sup>99</sup> =126.95 GeV* 126.64 GeV Blueprint for neutron decay: $\lambda_p-2\pi\lambda_{comp}$ (1109.96-229.82) s* = 880.14 s*/879.28 s
1.331x10 <sup>-44</sup> 7.088x10 <sup>-27</sup>	2.1264802x10 <sup>-18</sup> Higgs monopolar mean quantum bound from G as dineutron	5.59x10 <sup>-7</sup> 0.775558	2.6303496x10 <sup>11</sup> 876.78 s*	8.67x10 <sup>11</sup> 9.405x10 <sup>8</sup> J* 585.46 GeV*	1.6668x10 <sup>11</sup> K*	-	1/(1.351x0.9544)=0.775558
3.489x10 <sup>-42</sup> 1.858x10 <sup>-27</sup>	$2\pi\lambda_{comp}=4\pi^2 R_{comp}=5.57389763x10^{-19}$	3.84x10 <sup>-8</sup>	$R_{neutrondecay}=6.8946323x10^{10}$ 229.82 s*	1.69x10 <sup>12</sup> 3.588x10 <sup>-7</sup> J* 2.234 GeV*	4.5500x10 <sup>11</sup> K*	-	Modular RMP perimeter for primordial neutron decay (1109.96-229.82) s* = 880.14 s*, 879.28 s 1 <sup>st</sup> particular neutron twin is born from ylem neutron to blueprint primordial neutron decay

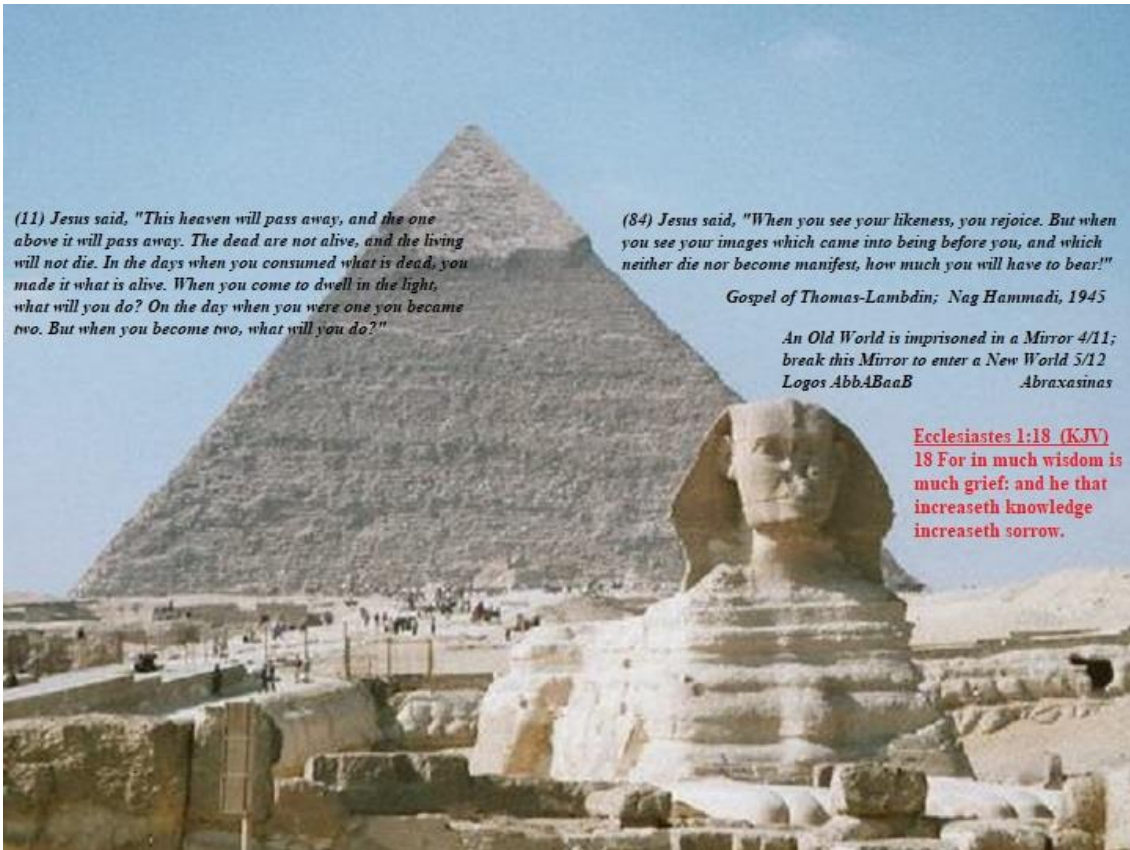

## XI: Initial Boundary Conditions for Matter-Antimatter Asymmetry

Timespace of imaginary space, created the initial boundary condition for the QBBS to manifest in the instanton-inflaton quantum entangled coupling in a higher dimensional parameter space of the mathimatia.

Five string classes transformed into each other under properties of modular dualities in the string epoch beginning with the 'bounce' of the Planck length at a then defined timespace coordinate of  $\sqrt{\alpha} L_{\text{planck}}/c = \sqrt{\alpha} t_{\text{planck}} = \sqrt{\{(hG_0/2\pi c^5)(2\pi k_e e^2/hc)\}} = \sqrt{\{G_0 k_e e^2/c^6\}} = e/c^3 = 5.9498383 \times 10^{-45} \text{ s}^*$  for the finestructure unification condition  $\{G_0 k_e = 1\}$  between the electromagnetic and gravitational interactions; and ending at the instanton of  $t_{\text{weyl}} = 3.333 \times 10^{-31} \text{ s}^*$ .

The heterotic classes allow the 5 bosonic strings to emerge from a 26-dimensional boson string space, where 10 clockwise string rotations are emergent in a 10-dimensional string spacetime and where 16 anti-clockwise rotation are suppressed.

The Planck boson in timespace then is known as the Planck string of class I of open strings at a time  $t_{\text{planck}} = 2\pi r_{\text{planck}}/c = 4.376 \times 10^{-43} \text{ s}^*$ ; the second a closed monopole string of self-dual class IIB at a time  $t_{\text{monopole}} = 2\pi r_{\text{monopole}}/c = 1.537 \times 10^{-40}$ ; the third the closed XL-Boson heterotic class HO(32) at time  $t_{\text{XL}} = 2\pi r_{\text{XL}}/c = 2.202 \times 10^{-39} \text{ s}^*$ ; the fourth the closed Ecosmic Ray-Boson string of class IIA at time  $t_{\text{Ecosmic}} = 2\pi r_{\text{Ecosmic}} = 6.618 \times 10^{-34} \text{ s}^*$  and the fifth the closed heterotic class HE(64) of the instanton.

A 'false Higgs Boson' vacuum at a time interval from  $t_{\text{dBmin}} = G_0 M_0 / c^3 n_{\text{ps}} = 4.672 \times 10^{-33} \text{ s}^*$  to  $t_{\text{dBmax}} = \sqrt{\alpha} t_{\text{weyl}} = 2.847 \times 10^{-32} \text{ s}^*$  preceded the instanton in the timespace to image the start of the timespace string epoch in the 'bounce' or quantum fluctuation of the Planck time in the 'quantum oscillation' of the Weyl time.

Following the creation of spacetime in the instanton, the Weyl parameters of the spacetime could integrate and manifest the primary source energy definitions of the mathimatia parameter space and using the string modular properties for that purpose.

One of those properties relates to the modular inversion of displacement in string T-duality, strongly associated with Mirror duality to connect the shadow-mirror universe Abba-Khaibit to the physicalized universe Friedmann-Baab.

The quantum entanglement between the two universes under modular string-membrane duality assumes the form of a supermembrane manifesting as a surface information agent in the two-sidedness of the Witten-Maria mirror of the 11-dimensional boundary between Khaibit-Universe-Energy-Primary-Source-Sink or Eps and Riemann-Universe-Energy-Secondary-Sink-Source or Ess.

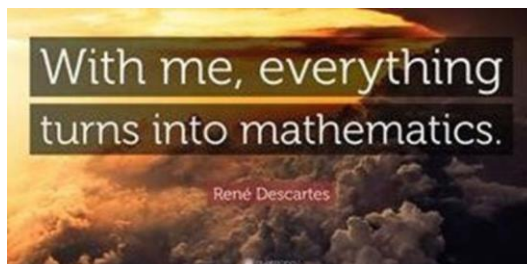

The supermembrane  $E_{ps}E_{ss}$  is the coupled under modular string-membrane duality in:

1.  $E_{ps}E_{ss} = hf_{ps} \times hf_{ss} = h^2$  with quantum energies  $E_{ps} = hf_{ps} = hc/\lambda_{ps} = hc/2\pi r_{ps} = m_{ps}c^2 = k_B T_{ps} = 1/e^*$  and  $E_{ss} = hf_{ss} = h/c\lambda_{ss} = 2\pi h/cr_{ss} = m_{ss}c^2 = k_B T_{ss} = h^2 e^*$
2.  $E_{ps}/E_{ss} = hf_{ps}/hf_{ss} = f_{ps}^2 = 1/f_{ss}^2$  with the inversion displacement coupling  $f_{ps}\lambda_{ps} = c = 1/\{f_{ss}\lambda_{ss}\}$  of modular T-Mirror duality
3. and descriptive for  $9 \times 10^{60}$  frequency permutation states for the universal physicalized consciousness quantum, the Uniphyscon defining Dirac's monopole.
4. The wormhole radius  $r_{ps} = \lambda_{ps}/2\pi$  and wavelength  $\lambda_{ps} = 2\pi r_{ps} = 10^{-22}$  m\* for a high quantum energy  $E_{ps}$  and a small winding string mode
5. The anti-wormhole radius  $r_{ss} = 1/r_{ps} = 2\pi\lambda_{ss} = 2\pi \times 10^{22}$  m\* and wavelength  $\lambda_{ss} = 2\pi r_{ss}$  for a low quantum energy  $E_{ss}$  and a great winding string mode

Quantum mechanics of a string physics of the very small so is characterized by a small wavelength and radius  $r$  of atomic and subatomic structures, but this radius  $r$  is shown to be equivalent to a classical mechanics of extended objects of inverted radius  $1/r$  in terms of the winding modes interchanging under T-duality.

A low winding number relative to a small radius  $r_{ps} = 1/R$  can describe a physics equivalent to that physics of the same radius  $r$  with a large winding number, as the unwinding of the multiplicity of the perimeter of the circle radius  $r$ , would increase the radius  $r_{ps} = 1/R$  to a multiple of  $1/R$  and so increase the radius to  $2\pi n \cdot r_{ps} = R = r_{ss}$  of classical objects.

For the supermembrane  $E_{ps}E_{ss}$ , the winding number becomes the coupling constant  $E_{ps}/E_{ss} = f_{ps}/f_{ss} = 9 \times 10^{60}$  as the maximum permutation frequency state as the self-state or resonance eigenvalue of the unification physics connecting the microcosmos of quantum relativity to the classical universe of general relativity with special relativity.

The Möbian connectivity of the 11-dimensional Witten-Maria mirror manifests in the timespace of the superstring epoch in the form of the quantum relative blueprints and the doubling of a Möbian surface in changing the one-sidedness to a two-sidedness in a double rotation or twist extending a 360-degree rotation to a 720-degree rotation to return to an initial state, known as a spinor.

A two-sided ring of width  $w$  and radius  $r$  so has two surface areas  $2\pi rw$  as an inner and an outer. Cutting the ring and twisting one end by 180 degrees, before gluing it back to the other end of the ring will connect the previously separated surfaces to one surface of total length  $4\pi r$  and surface area  $4\pi rw$ .

A spinor pointing perpendicular to the width would then change direction after one full rotation because of the twist and require and more rotation to return to the initial starting position. Righthandedness becomes left-handedness after a 360-degree rotation and becomes righthanded again after another 360-degree rotation.

This property of a geometric topological transformation from an orientable geometric object like a ring into a non-orientable object like a Möbius strip became the basis for the quantum geometry of fundamental particles blueprinted in the supersymmetry of the timespace.

Five-gauge Goldstone bosons as the 'force carrying' field particles broke the supersymmetry of the unification of five interaction fields:

#	Gauge Boson	Colour Charge	Spin	Field
1	Eps-Photon	Cyclic RGB	+1	EMI
2	Ess-Antiphoton	Anticyclic BGR	+1	WNI
3	Graviton	Anticyclic BGR	-2	GI
4	Gluon	Cyclic RGB	+1	SNI
5	Restmass-Photon	Cyclic $Y^2C^2M^2$	-1	EMMI
6	Higgs-Boson	Cyclic $Y^2C^2M^2$	0	EMMI
	Dirac Monopole Mirror			
7	Anti-Higgs Boson	Anticyclic $M^2C^2Y^2$	0	Imaginary EMMI
8	Anti-Restmass-Photon	Anticyclic $M^2C^2Y^2$	+1	Imaginary EMMI
9	Anti-Gluon	Anticyclic BGR	-1	Imaginary SNI
10	Anti-Graviton	Cyclic RGB	+2	Imaginary GI
11	Ess-Photon	Cyclic RGB	-1	Imaginary WNI
12	Eps-Antiphoton	Anticyclic BGR	-1	Imaginary EMI

The cyclic right-handed Eps-Photon of Monopolar Radiation EMMR for the long-range Electromagnetic Interaction (EMI) is known as the 'virtual' photon of U(1)-SU(2)-SU(3) Unitary gauge symmetry of the Standard Model of particle physics combining Quantum Field Theory (QFT) in Quantum Electrodynamics (QED) with Quantum Chromodynamics (QCD).

Its anti-particle would so be an anticyclic left-handed Ess-Photon in the supersymmetry of the Unified Field of Quantum Relativity (UFoQR).

The Quantum Relativity derives from the geometric topology creating and defining the elementary particle and gauge bosons in their quantum geometry in the timespace and preceding the string-membrane epoch in the mathimatia.

The cyclic RGB on one side of the Möbian strip would interact with its own image of the one-sidedness, however separated by the point-circle of the one-dimensional thickness of the Möbian geometry in the spacelessness or imaginary space of timespace.

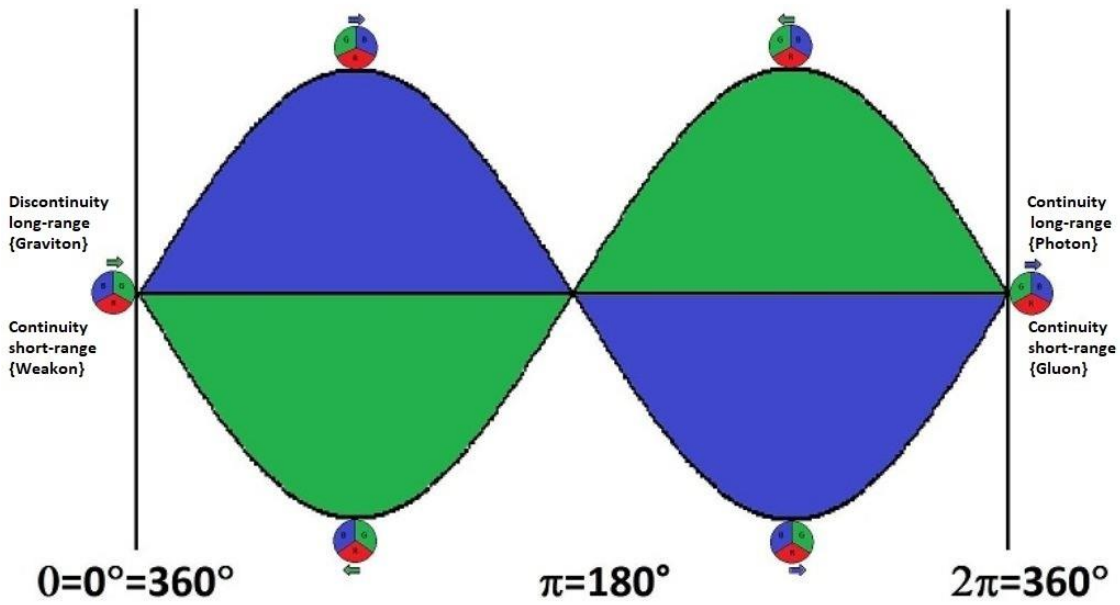

**Abba Mirror**  
**Eps=Energy Primary SourceSink**  
**{God CreatorCreation}**

**Inflexion Nexus**

**Baab Mirror**  
**Ess=Energy Secondary SinkSource**  
**{AntiGod-Satan CreationCreator}**

**Father White Hole Energy Source-Sink**  
**Universal 12D-11D-Supermembrane**  
**Vibratory High Frequency  $f_{ps} = 1/f_{ss}$**   
**Creation Quantum Big Bang Wormhole**  
**Weyl-Frequency  $3 \times 10^{30}$  Hertz**

**Mother Black Hole Energy Sink-Source**  
**Universal 10D-11D-Supermembrane**  
**Winding Low Frequency  $f_{ss} = 1/f_{ps}$**   
**Creation Quantum Big Bang Anti-Wormhole**  
**Mass-Eigen-Frequency  $3.33 \dots \times 10^{31}$  Hertz**



**Abba-Eps Photon{+1} long**  
**EMI: Monopolar EMR**  
**SNI: Gluon{+1} short**

**Baab-Ess Photon{+1} short**  
**Monopolar Anti-EMR**  
**Suppressed Anti-Radiation**  
**GI: Graviton{-2} long**

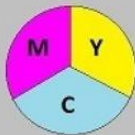
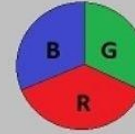

**Matter Template  $\{\pm\frac{1}{2}\}$**   
**Basic Nucleon-Neutron**  
**YCM=CMY=MYC=YCM**  
**Cyclic Permutative**

**Anti-Matter Template  $\{\pm\frac{1}{2}\}$**   
**Basic Anti-Nucleon Anti-Neutron**  
**MCY=CYM=YMC=MCY**  
**Anticyclic Permutative**

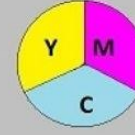

**Anti-Neutrino Template  $\{+\frac{1}{2}\}$**   
**(RR)(GG)(BB)=(GG)(BB)(RR)=...**  
**Cyclic Permutative**  
**W-minus Matter Weakon {+1}**  
**= YCM $\{+\frac{1}{2}\}$  + (RR)(GG)(BB) $\{+\frac{1}{2}\}$**   
**WNI: Weakon{+1} short**

**Neutrino-Template  $\{-\frac{1}{2}\}$**   
**(BB)(GG)(RR)=(GG)(RR)(BB)=...**  
**Anticyclic Permutative**  
**W-plus Anti-Matter Weakon{-1}**  
**= MCY $\{-\frac{1}{2}\}$  + (BB)(GG)(RR) $\{-\frac{1}{2}\}$**   
**WNI: Weakon{-1} short**

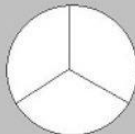

**Graviphoton GP{-1} short**  
**Dark Matter Template**  
**QGI: Quantum Gravity short**

**Higgs Boson HB{0} short**  
**RestMass Photon RMP{-1}**  
**Universal Consciousness Agent**

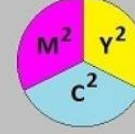

**The Creation of the Graviton in the Unified Field Of Quantum Relativity**

Quantum Gravity emerges from the Conservation of Gauge Supersymmetry of SourceSink Energy, of Colour Charges and Quantum Spin from Templates of a Quantum Geometry

{Encoded and decoded from Ezekiel.28.13-19 with Isaiah.14.13-14 - masoretic texts}

The self-intersection of the Eps-Photon with its antistate of the Ess-Antiphoton through a membrane mirror of no thickness would mix the Red-Green-Blue cyclic colour triplet on one side of the mirror as a cyclic Eps rotation  $RGB=GBR=BRG$  in three successive 120-degree angular displacements.

Relative to Ess, this movement would be identical in the quantum self-relativity of rotating from RGB to GBR to BGR, but relative to the other side of the mirror the movement would be anticyclic.

The colour charge triplet RGB is defined in the parameters of EMR as Planck's Law  $E=hf$  and 'light' and in parameters of mass as Einstein's Law  $E=mc^2$  or 'dark'. Electromagnetically Red, Green, and Blue in equal proportions result in the colour White and colour in the matter of paint in equal proportions result in the colour Black in the colour charge triplet Yellow-Cyan-Magenta or YCM.

In the SU(3) gauge symmetry of QCD, the eight forms of the gluon, transmitting the force of the strong nuclear interaction reduce to one gluon agent in 8 and 4 permutation states.

For hadrons, like nucleons like the proton and the neutron, and constructed by three quarks, the eight gluon permutations transform a pure Black triplet into a pure White triplet in the set:  $\{BBB+BBW+WBB+BWB+WBW+WWB+BWW+WWW\}$ .

For mesons and other quark-antiquark state particles the four gluon permutation states are the set:  $\{BB+BW+WB+WW\}$ .

The primary colour charge triplet RGB then forms a radiation-matter interaction super template with the secondary colour charge triplet YCM in the Black-White resonances given in the colour-anticolour couplings  $Red+Cyan=W$  or  $B$  and  $Green+Magenta=W$  or  $W$  and  $Blue+Yellow=W$  or  $B$  via  $E=hf$  for  $W$  or  $E=mc^2$  for  $B$ , respectively.

The original YCM blueprint for matter was created by a half-rotation in the  $60^\circ$ - $120^\circ$  sector where the colour charge interaction  $(R+G)(G+B)(B+R)=YCM=CMY=MYC$ , was followed by the second half-rotation in the  $240^\circ$ - $300^\circ$  sector from the inflexion point of  $180^\circ$  manifesting in spacetime as the Möbian twist of  $180^\circ$  to change the orientability of the Möbian topology to non-orientable.

The colour charges of both the self-relative sources Eps and Ess inflexed to Blue-Green-Red to give the antimatter template  $(B+G)(G+R)(R+B)=CYM=YMC=MCY$ .

At the completion of the  $360^\circ$  rotation, only the primary gauge photon Eps inflected back to its starting position of a cyclic right-handedness, the secondary gauge photon Ess broke the gauge supersymmetry in continuing with its cyclic right-handedness so creating the necessity for the birth of the graviton as a spinor of double integer spin to reset the gauge symmetry in the timespace.

This resulted in the suppression of the antimatter template MCY as the mirror of the mass eigenstate to the eigenstate of the BGR anti-EMMR blueprint.

The breaking of the gauge symmetry at the inflexion points of  $0^\circ$ - $180^\circ$ - $360^\circ$  differentiated the even  $\pi$ -nodes at  $0$  and  $2\pi$  radians from the odd  $\pi$ -nodes at  $\pi$  radians in defining the even nodes in RGB and as an anti-neutrino template  $R^2\hat{G}^2B^2$  and the odd nodes in BGR and as neutrino template  $B^2\hat{G}^2R^2$ .

The original 'short-range' wave function for the EMMI of quantum spin +1 at the origin with the original wave function for the Anti-EMMI of quantum spin -1 and inflecting at the  $180^\circ - \pi$  node in the UFoQR as  $UFoQR(x) = \sin(x) + \sin(-x)$ , now took the 'long-range' form  $UFoQR(x) = \sin(3x/2) - \cos(3x/4)$  in Eps continuing to inflect at odd  $\pi$ -nodes and intersecting with the graviton wave function in lieu of the now suppressed Anti-EMMI wave function, effectively retracing the path of Eps with a phase shift of  $2\pi$  or  $360^\circ$ .

The combined wave function of the EMI and the GI then repeats its waveform in a periodicity of  $8\pi$  radians or  $1440^\circ$  and intersects in 12 coordinates to define the materialization of particles and anti-particles in the combined wave path of  $4\lambda_{ps}$  or four times the Weyl wormhole perimeter manifesting in the QBBS spacetime of the instanton-inflaton.

The 2<sup>nd</sup> intersection or current node in the UFoQR then defines a  $Y^2C^2M^2$  template for the Higgs Boson of 0 spin and the 4<sup>th</sup> current junction defines the Anti-Higgs Boson of 0 spin as the  $M^2C^2Y^2$  blueprint.

As the coordinates for the 1<sup>st</sup> and 2<sup>nd</sup>, the 3<sup>rd</sup> and 4<sup>th</sup> to the 5<sup>th</sup> junction nodes are  $120^\circ$  and  $288.5^\circ$  and  $360^\circ$  and  $431.5^\circ$  and  $600^\circ$  respectively to encompass the Weak Nuclear Interaction (WNI) part of the UFoQR in coupling the matter loops to the antimatter loops; two additional  $Y^2C^2M^2$  and  $M^2C^2Y^2$  templates are made manifest as the blueprints for the Restmass-Photon RMP of spin=-1 at the  $200^\circ$  coordinate and the Anti-RMP of spin=+1 at the  $520^\circ$  coordinate.

The templates for the creation of particles in the spacetime from the timespace so allows the bosonic integral boson-spins to bifurcate into fermionic half-integer spins for any YCM or MCY created particle pairs, such as an ylemic YCM Gamow neutron boson of spin=+1 splitting into two neutrons of spin=+ $\frac{1}{2}$  in conjugate or parallel action of an ylemic MCY Gamow anti-neutron boson with spin=-1 splitting into two fermionic neutrons of spins  $-\frac{1}{2} - \frac{1}{2}$ .

But this standard scenario of the Big Bang cosmology infers the equal status between matter and antimatter for the cosmogenesis.

The antimatter template MCY remains suppressed as a function of the anti-EMMI template, which also internalizes the anti-RMP and the anti-Higgs bosons into the UFoQR.

So, it is the Higgs Boson which manifests the elementary particles of the cosmogenesis in splitting its  $Y^2C^2M^2$  matter template into an ylemic YCM Gamow neutron pair with opposite spins  $+\frac{1}{2} - \frac{1}{2} = 0$ .

This gives the reason as to why no normally occurring antimatter is observed in the universe, apart from the process of pair-creation defined in the UfoQR between junction nodes 8-9-10 at coordinates of  $-528.5^\circ - 360^\circ - 191.5^\circ$ .

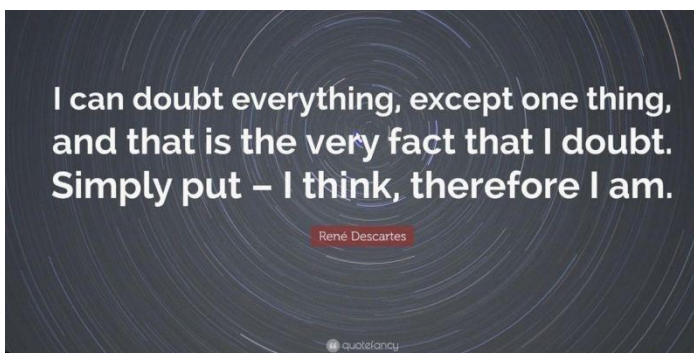



# The Unified Gauge Parameter Field of Quantum Relativity

Primary-Secondary-Tertiary Colour Triplets of the Chromaticity Unities in the UFoQR 1-2-3-4-5-6-7-8-9-10-11-12-13 Anticolours for 8 Gluon Permutations in Energy gravitational  $E=mc^2$  for B(lack) and Energy radiative  $E=hf$  for W(hite) R+C and O+A and Y+B and L+I and G+M and T+P and C+R and A+O and B+Y and I+L and M+G and P+T and R+C

Gluon RGB=(RG)B=YB=CR=MG=YB=CR=MG=RGB

for: {BBB;BBW;BWB;BWW;WBB;WBW;WWB;WWW} hyperonic triplets and {BB;BW;WB;WW} mesonic doublets

R(ed)-O(orange)-Y(ellow)-L(ime)-G(reen)-T(urquoise)-C(yan)-A(quamarine)-B(lue)-I(ndigo)-M(agenta)-P(urple)-R(ed)

The 12 Junction-Loops of the Unified Field Natural Current Field in Quantum Relativity Extent:  $4\lambda_{ps}$  & Amplitude= $\lambda_{ps}/2\pi$

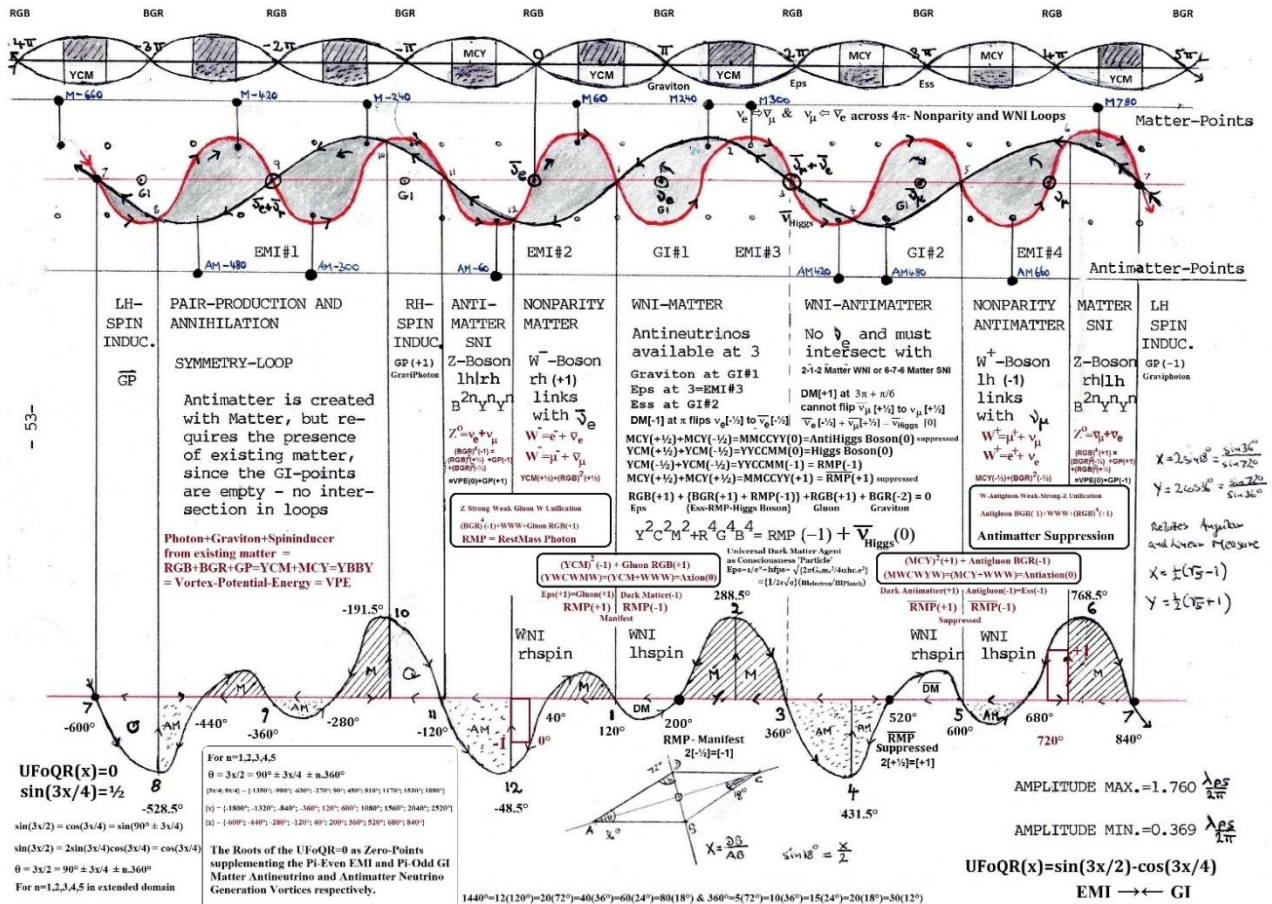

**EM(M)=ElectroMagnetic (Monopolic) Radiation Interaction = Unified Field of QR before spacetime creation**

**(Inflation to Quantum Big Bang) without Gravitational Interaction GI**

**Metaphysical Abstraction of Mathimatia Supersymmetry by Logos Definition in Radiation-Antiradiation Symmetry**

**Möbian-Klein Twosided 11D-Mirror SelfIntersection:**  $RGB(+1)+RGB(-1) \Rightarrow RRGBB(0) \Rightarrow YCM(0)+YCM(0) \Rightarrow BBGRR(0) \Rightarrow MCY(0)+MCY(0) \Rightarrow BGR(-1)+BGR(+1)$

Eps=RGB(+1) at 0°.....Ess=RGB(-1) at 360°.....Eps=BGR(-1) at 180° Inflexion Ess=BGR(+1)  
 Ess=RGB(+1) at 0°.....Eps=RGB(+1) at 360°.....Breaking of the metaphysical supersymmetry in quantum spin to allow the birth of the Graviton and matter-antimatter symmetry, suppressing however the matter-antimatter symmetry in the reformulation of antiradiation  
 [Encoded as the retracing of the 'steps' of the creator' --Ezekiel.28.13-19; Isaiah.14.12-14]

**Unified Field of QR in the 11D-Membrane Inflation, followed by a Quantum Big Bang of Relativistic Thermodynamic Cosmology Physicalisation of the Metaphysical Precursor in an inherent Matter-Antimatter Asymmetry**

**Möbian-Klein Onesided 10D/12D-Mirror SelfIntersection as the Goldstone Boson Unification of all Interactions in the UFOQR:**

**RGB(+1)+BGR(-1)+RGB(+1)+BGR(-2)+YYCCMM(-1) = EMI Eps-Photon + WNI Ess-Antiphoton + SNI Gluon + Graviton + EMMR-RMP**

**= MGGM(+2)+MGGM(-1)+YYCCMM(-1) = VPE(+2)+VPE(-1)+YYCCMM(-1) = VPE(+1)+YYCCMM(-1) = EMMR UFOQR Unification**

The Ess-Anti-Photon(+1) is suppressed as Goldstone ambassador gauge in spin +1 by the SNI ambassador Gluon and is suppressed in colour charge BGR by the GI gauge ambassador Graviton. The birth of the Graviton demands a net spin of +1 of the Vortex-Potential Energy or VPE/ZPE to become neutralized by the fifth gauge ambassador of the RMP with spin -1 as the gauge ambassador and Goldstone Boson as the primal gauge ambassador for the consciousness energy interaction encompassing all particular constituents in the Unified Field of Quantum Relativity.

The graviton must have spin 2 because of quantum angular momentum conservation.

Before spacetime creation in the instanton of the quantum Big Bang, the transformation of the five string classes manifested in the inflaton using a prior supersymmetry between matter- and antimatter templates, represented in say  $\sin x + \sin(-x) = 0$  and where the positive region becomes a quantum geometric matter conformal mapping, and the negative region becomes its conjugative for antimatter.

As the linearization of the circle inflects at 180 degrees, matter and antimatter become defined in adjacent clockwise and anticlockwise semi cyclicities.

If now the arbitrary boundaries are defined in some unitary interval between 0 and 360 degrees or  $[-\infty, 0, +\infty]$  or  $[-1, 0, +1]$  or  $[0, \frac{1}{2}, 1]$  or  $[-(X+1), -\frac{1}{2}, X]$ ; then the left boundary dynamics of say righthandedness cancels the right boundary dynamic of left-handedness throughout the 2 semi cycles, say described in a Möbian connectivity and topology of surface non-orientability in a conformal mapping of a 2D surface onto a 11D supermembrane in a membrane-mirror space.

After the completion of a full cycle, the matter- and antimatter templates exist in the membrane space of the inflaton, say as a supersymmetry between the righthanded electromagnetic monopolar radiation (EMMR) and its antistate in a lefthanded electromagnetic monopolar antiradiation.

This supersymmetry between radiative self-states precedes any possible supersymmetry between the matter and antimatter blueprints, as the dynamic of the EMMR eigenstate defines the former as a secondary manifestation of potential manifestation, once the instanton of spacetime creation supersedes that of the prior string-brane epoch.

To realize the matter-antimatter potential, the completion of the full EMMR cycle breaks its own supersymmetry in the exchange of the right- and left boundary and initial conditions.

The original righthanded (Weyl-gauge photon say of the left mirror) now situated at the right mirror extends the unitary interval towards the positive abscissa (aleph null enumerability) and inflects its anticlockwise parity into its original clockwise parity or chirality.

The original Weyl-antiphoton from the right mirror, now situated at the left mirror retraces the path of the Weyl-gauge photon however and so does not inflect and so creates the necessity to negate two clockwise quantum spins by a doubled anticlockwise spin angular momentum.

This demands the birth of quantum gravity and of its gauge agent of the graviton in the formation of a new universal wavefunction traversing in the opposite direction of the now twinned electromagnetic monopolar propagation of the original emmr supersymmetry.

A consequence of this 'changing of the fundamental supersymmetry' becomes the restriction of any matter-antimatter symmetry to become confined to the concept of pair production in the presence of existing matter or antimatter in Nonparity.

Defining matter to couple in a Goldstone gauge boson form to the original Weyl-photon (RGB) then forces the Weyl-antiphoton (anticyclic BGR) to suppress the antimatter (MCY anticyclic to matter YCM) template in lieu of a 'twinned' emergent blueprint known as the scalar 0-spin Higgs Boson ( $Y^2 C^2 M^2$ ).

Imagine a Möbius strip without thickness and so restricted to be two dimensional. The perimeter of the quasi-inner ring so defines a self-intersection with its quasi-outer ring and depicts half of the total 2D-space of the Möbius strip for the inflection at 180 degrees. Then the Möbius strip breaks its own non-orientable nature and symmetry to create the 3rd dimension as a form of the Dirac string rotating in the 2-dimensional XY-plane to manifest the orthogonal z-direction in the torque of the angular momentum vector.

The second parameter space can now become orientable (without the Möbius twist of 180 degrees) and the self-relativity of the first part becomes now 3-dimensional relative and allows a new mixing of the tripartite sectors of the quantum chromodynamics of the constituent Goldstone bosons. From this point in the cosmogony onwards an older non-manifested matter antimatter supersymmetry can eventuate in the observed pair-production, being otherwise suppressed by the earlier radiation-antiradiation supersymmetry described.

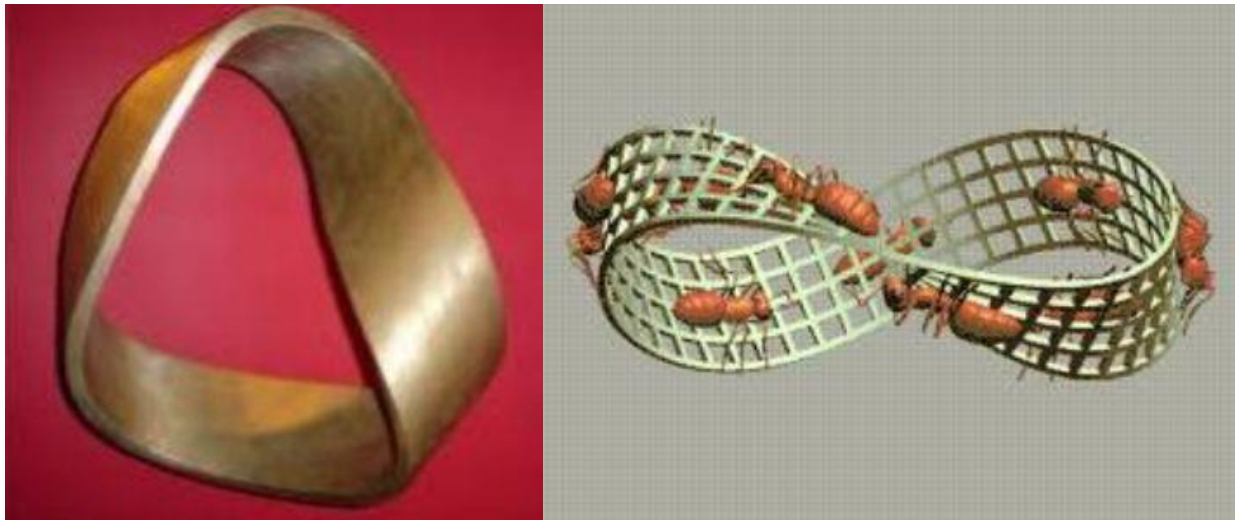

<https://youtu.be/sRTKSzAOBr4>



## The Antimatter - Matter Asymmetry as effect of Quantum Geometry in Diquarks

A contemporary 'controversy' and mystery in the Standard Model compares charged B-meson decay CP parity violation with uncharged B-mesons in the quest to solve the matter-antimatter asymmetry.

[Antimatter Mystery Continues To Perplex Scientists \(forbes.com\)](https://www.forbes.com/sites/drdonl...tter-mystery-continues-to-perplex-scientists/)

<https://www.forbes.com/sites/drdonl...tter-mystery-continues-to-perplex-scientists/>

The answer is the nature of the 2nd and 3rd quark families. The c, b and t quarks are diquarks. There was no antimatter at the Quantum Big Bang Singularity event (Timespace instanton triggering a Spacetime inflaton). So called supersymmetry is inherent in the pre-spacetime boundary conditions defined in the Dirac String/Monopole. <https://www.bitchute.com/video/WABQpOJawitJ/> 2

The charged B-mesons have only an internal integer charged ring/antiring structure manifesting their structure say  $b\bar{u}=[\bar{u}d]$  or  $\bar{u}b=[u\bar{d}]$  as antiproton or proton quantum quark geometry of the internal down/antidown quark manifesting the weakon ring charge as the interaction transmitter.

The single ring/antiring structure manifests a c-quark component ( $\bar{u}c$  or  $c\bar{u}$ ). The neutral B-mesons say  $b\bar{d}=[\bar{d}u]$  or  $\bar{d}b=[u\bar{d}]$  manifest the neutral (anti)neutron/lambda quantum geometry and therefore suppress the matter-antimatter divergence in the weakon kernel-inner ring /down-outer ring/strange oscillations. The two ring/antiring components cancel.

Ten DIQUARK quark-mass-levels crystallize, including a VPE-level for the K-IR transition and a VPE-level for the IR-OR transition:

The K-Means define individual materializing families of elementary particles:

a (UP/DOWN-Mean) sets the (PION-FAMILY:  $\pi^0, \pi^+, \pi^-$ ).

a (STRANGE-Mean) specifies the (KAON-FAMILY:  $K^0, K^+, K^-$ ).

a (CHARM-Mean) defines the (J/PSI= $J/\psi$ -Charmonium-FAMILY).

a (BEAUTY-Mean) sets the (UPSILON= $\Upsilon$ -Bottonium-FAMILY).

a (MAGIC-Mean) specifies the (EPSILON= $E$ -FAMILY).

a (DAINTY-Mean) bases the (OMICRON= $O$ -FAMILY).

a (TRUTH-Mean) sets the (KOPPA= $K$ -Toponium-FAMILY) and

a (SUPER-Mean) defines the final quark state in the (HIGGS/CHI= $H/X$ -FAMILY).

# The Universal Quantum Geometric Matter-AntiMatter Template

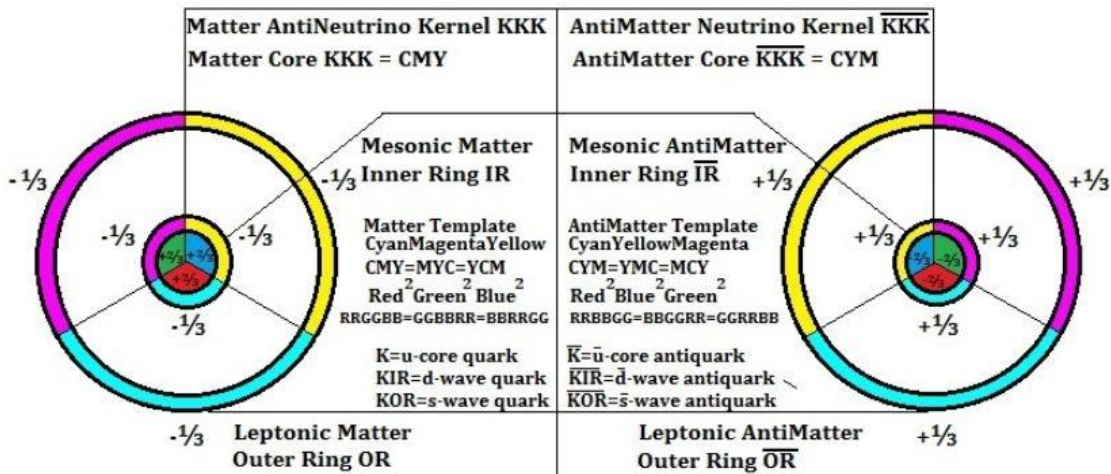

ElectroCharge  $3(-\frac{1}{3}) = -1$  for IR & OR  
MagnetoCharge RGB = 0 for IR & OR

ElectroCharge  $3(+\frac{1}{3}) = +1$  for IR & OR  
MagnetoCharge BGR = 0 for IR & OR

ElectroCharge  $3(+\frac{2}{3}) = +2$  for Kernel KKK  
MagnetoCharge RRGGBB = 0 for Kernel KKK

ElectroCharge  $3(-\frac{2}{3}) = -2$  for Kernel KKK  
MagnetoCharge BBGGRR = 0 for Kernel KKK

MagnetoCharge = ColourCharge = GluonCharge

Matter OR  
Outer Ring B  
BBB=Black

$W^-$

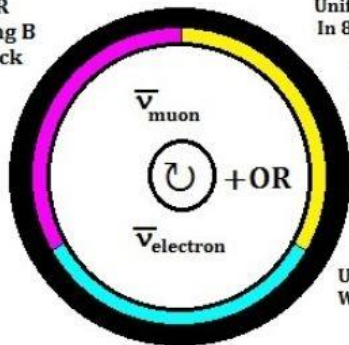

Unified Kernel = Gluon for Strong Nuclear Interaction  
In 8 KKK Permutations of the MagnetoCharge:

{BBB=Pure massive eigenstate in  $E=mc^2$   
BBW; BWB; WBB; BWB; WBW; WWB;  
WWW=Pure radiative eigenstate in  $E=hf$   
3-quark content: hyperons-baryons-nucleons

And in 4 K̄K̄ Permutations:  
{BB; BW; WB; WW}  
quark-antiquark content: mesons

Unified Kernel = (Anti)Neutrino for  
Weak Nuclear Interaction & 0 ElectroCharge

AntiMatter OR  
Outer Ring W  
WWW=White

$W^+$

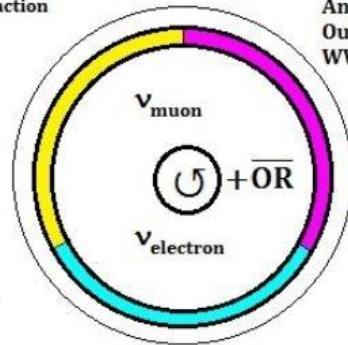

**Matter Weakon W-minus**

ElectroCharge -1 for OR

Muon  $\mu^-$  or Electron  $e^-$

MagnetoCharge = 0 for AntiNeutrino Core

[+]

Clockwise  
Righthand

[-]

Anticlockwise  
Lefthand

Quantum Spin

**AntiMatter Weakon W-plus**

ElectroCharge +1 for OR

AntiMuon  $\mu^+$  or Positron  $e^+$

MagnetoCharge = 0 for Neutrino Kernel

$$e^- + \bar{\nu}_{electron} = W^- [+1] = \mu^- + \bar{\nu}_{muon}$$

$$OR\text{-Flip} = W^- [+1] + \text{GraviPhoton} [-1]$$

Vortex-Potential-Energy  
VPE = ZPE

**OR-Flip**  
**+ OR-Flip**  
(Core +OR)VPE

YCM+YMC=(CM=B)YY(B=MC)  
BYBY=GMMG=RCCR  
YBBY=CRRC=MGGM  
RGB+RBG=(GB=C)RR(C=BG)

$$e^+ + \nu_{electron} = W^+ [-1] = \mu^+ + \nu_{muon}$$

$$\overline{OR}\text{-Flip} = W^+ [-1] + \text{GraviPhoton} [+1]$$

Neutron  $\Rightarrow$  Proton + Electron + Electron AntiNeutrino

Basic Neutron Beta-Minus Decay:  $n^0 [-1/2] \Rightarrow p^+ [-1/2] + e^- [-1/2] + \bar{\nu}_e [+1/2]$

$d[-1/2]u[+1/2]d[-1/2]$ (stable in nucleus) $\Rightarrow u[+1/2]d[-1/2]d[-1/2]$ (free)  $\Rightarrow u[+1/2]d[-1/2]d^*[-1/2]$  (IR-OR Oscillation)

$\Rightarrow u[+1/2]d[-1/2](u[-1/2].W^+ [+1].GP[-1]) \Rightarrow u[-1/2]d[+1/2]u[-1/2] + e^- [-1/2] + \bar{\nu}_e [+1/2] \Rightarrow udu[-1/2] + \text{electron-OR}[-1/2] + \bar{\nu}_e [+1/2]$

Muon  $\Rightarrow$  Electron + Electron AntiNeutrino + Muon Neutrino

Basic Muon Weak Decay:  $\mu^- [-1/2] \Rightarrow e^- [-1/2] + \bar{\nu}_e [+1/2] + \nu_\mu [-1/2]$

$OR^- [-1/2]$  (free)  $\Rightarrow OR^- [-1/2]$  (KKK-OR Oscillation)  $\Rightarrow (\nu_\mu . OR)^- [-1/2] . (W^+ [+1].GP[-1]) \Rightarrow e^- [-1/2] + \bar{\nu}_e [+1/2] + \nu_\mu [-1/2]$

Only lefthanded matter particles and only righthanded antimatter particles participate in the Weak Nuclear Interaction in a fundamental Nonparity between Matter and Antimatter and as a consequence of the magnetocharged gauge interaction particles suppressing any naturally occurring antimatter in a inflationary and 'Big Bang prior' radiation-antiradiation grand symmetry 'Goldstone Boson' superstring unification:

RGB/SourceSink Photon(+1)+{BGR/SinkSource Photon(+1)+RestMass Photon(-1)}+RGB/Gluon(+1) +BGR/Graviton(-2)=0 and in coupling to the templates for Matter YCM and Antimatter MCY.

The suppressed SinkSource Photon (Devil/AntiGod Particle) with the 'Dark Matter/Energy Particle' descriptive in the definition of Consciousness/Space Awareness transforms into a Scalar Higgs Gauge Boson to form a recreated Supersymmetry in the Unified Field of Quantum Relativity or UFOQR.

The Gauge Photon RGB(+1) can also be described in the high energy vibratory part Eps of the supermembrane EpsEss with the Gauge Photon BGR(+1) its low energy winded conjugative part Ess.

The Scalar Higgs AntiNeutrino  $(RGB)^4 [0] + (RGB)^2 [+1/2]$  creates the Tau AntiNeutrino  $\bar{\nu}_\tau [+1/2]$  in Leptonic Energy Resonance. The Scalar Higgs Neutrino  $(BGR)^4 [0] + (BGR)^2 [-1/2]$  creates the Tau Neutrino  $\nu_\tau [-1/2]$  in Anti-Leptonic Energy Resonance.

Quantum Spin Conservation in Photon-Matter Interaction via Dark Matter agency of the Higgs Boson HB+RMP Superposition

HB+AntiRMP superposition:  $YCM[0]+MCY[+1]$   
 AntiHB+RMP superposition:  $MCY[0]+YCM[-1]$  } Unified Field Dark Matter Agency  $2x\{YYCCMM[0-1] + MMCCYY[0+1]\} = 2x\{BBYY[0]\}$   
 Via Gravitational Interaction from 5D-Kaluza Klein Graviton-Graviphoton-Graviscalar spacetime

Pair-Production

High Energy Photon  $\gamma[-1]$ (no colour charge) + AntiHB[0](MCY)RMP[-1](YCM)  $\Rightarrow (BBYY)[0] \Rightarrow YCM[-1/2] + MCY[+1/2]$

High Energy Photon  $\gamma[-1]$ (no colour charge) + HB[0](YCM)AntiRMP[+1](MCY)  $\Rightarrow (BBYY)[0] \Rightarrow YCM[-1/2] + MCY[+1/2]$

Photon Emission from Atomic Electron Emission/Transmission

Electron  $YCM[+1/2] + \text{Graviphoton}[-1] \Rightarrow \text{Electron } YCM[+1/2] + \gamma[-1]$

Electron  $YCM[-1/2] + \text{Graviphoton}[+1] \Rightarrow \text{Electron } YCM[-1/2] + \gamma[+1]$

The importance of Kernel-Symmetry so is evidenced in the differentiation of the quarkian permutations and specifying for example the KKIRKOR quark state  $uds$  as a tripartite symmetry of  $u.d.s$  (least stability as SNI-decaying  $\Sigma^0$  resonance) and  $u.s.d$  (EMI-stable  $\Sigma^0$  particle) and  $d.u.s$  (WNI-most stable  $\Lambda^0$  particle).

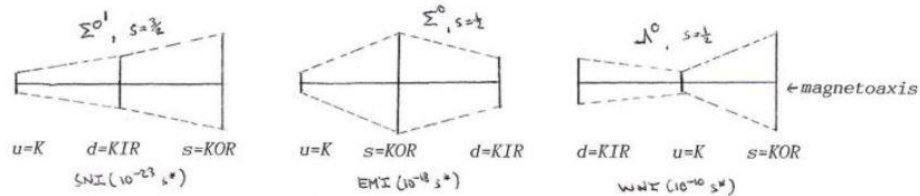

The importance of the  $uds$ -lambda quantum geometry

1-10-19	AJS/ajs	AIS/αισ	Aleph-א	Yod-י	Shin-ש	$dud = n^0$ $d(-\frac{1}{2})u(\frac{1}{2})d(-\frac{1}{2})$ QGS Neutron(0)	$ud=b=K+KIR=KKIR$ $dd=D=KIRKIR$	$udd=ddu=KKK+IRIR$ $uD=bd=db=Du$	$udd=ddu=\Delta^0$ $u(-\frac{1}{2})d(-\frac{1}{2})d(-\frac{1}{2})$ SNI Delta(0)
2-11-20	BKT/bkt	BKT/βκτ	Bet-ב	Kaf-כ	Tav-ת	$udu = p^+$ $u(-\frac{1}{2})d(\frac{1}{2})u(-\frac{1}{2})$ QGS Proton(+)	$du=b=KIR+K=KIRK$ $uu=U=KK$	$duu=uud=KKK+IR$ $dU=bu=ub=dU$	$duu=uud=\Delta^+$ $d(-\frac{1}{2})u(-\frac{1}{2})u(-\frac{1}{2})$ SNI Delta(+)
3-12-21	CLU/clu	ΓAY/γλν	Gimel-ג	Lamed-ל	Tet-ט	$usu = \Sigma^+$ $u(-\frac{1}{2})s(\frac{1}{2})u(-\frac{1}{2})$ QGS Sigma(+)	$su=m=KOR+K=KORK$ $uu=U=KK$	$suu=uus=KKK+OR$ $sU=mu=um=Us$	$suu=uus=\Sigma^+$ $s(-\frac{1}{2})u(-\frac{1}{2})u(-\frac{1}{2})$ SNI Sigma(+)
4-13-22	DMV/dmv	ΔMψ/δμψ	Dalet-ד	Mem-מ	Tsadi-צ	$dsd = \Sigma^-$ $d(-\frac{1}{2})s(\frac{1}{2})d(-\frac{1}{2})$ QGS Sigma(-)	$sd=t=KOR+KIR=KORKIR$ $dd=D=KIRKIR$	$sdd=dds=KKK+IRIROR$ $sD=td=dt=Ds$	$sdd=dds=\Sigma^-$ $s(-\frac{1}{2})d(-\frac{1}{2})d(-\frac{1}{2})$ SNI Sigma(-)
5-14-23	ENW/enw	ENΩ/ενω	He-ה	Nun-נ	Ghayin-ג	$sus = \Xi^0$ $s(-\frac{1}{2})u(\frac{1}{2})s(-\frac{1}{2})$ QGS Xi-Chi(0)	$us=m=K+KOR=KKOR$ $ss=S=KORKOR$	$uss=ssu=KKK+OROR$ $uS=ms=sm=Su$	$uss=ssu=\Xi^0$ $u(-\frac{1}{2})s(-\frac{1}{2})s(-\frac{1}{2})$ SNI Xi-Chi(0)
6-15-24	FOX/fox	ΦOX-Ξ/φοχ-ξ	Vav-ו	Ayin-א	Samekh-ס	$sds = \Xi^-$ $s(-\frac{1}{2})d(\frac{1}{2})s(-\frac{1}{2})$ QGS Xi-Chi(-)	$ds=t=KIR+KOR=KIRKOR$ $ss=S=KORKOR$	$dss=ssd=KKK+IROROR$ $dS=ts=st=sd$	$dss=ssd=\Xi^-$ $d(-\frac{1}{2})s(-\frac{1}{2})s(-\frac{1}{2})$ SNI Xi-Chi(-)
7-16-25	GPY/gpy	Γ*ΠY*/γ*πν*	Gimel*-ג*	Pe-פ	Tet*-ט*	$uds=sdu=\Sigma^0$ $u(-\frac{1}{2})d(-\frac{1}{2})s(-\frac{1}{2})$ SNI* Sigma*(0)	$Udbar=K+K-VPE-\bar{K}$ SNI-Decay (-1/2,1) (b=ud: c <sup>+</sup> =uu.ū & c <sup>-</sup> =ūū.u)	$uuu=U=U=KKK$	$uuu=\Delta^{++}$ $u(-\frac{1}{2})u(-\frac{1}{2})u(-\frac{1}{2})$ SNI Delta(++)
8-17-26	HQZ/hqz	HΘZ/ηθζ	Het-ח	Qof-ק	Zayin-ז	$usd=dus=\Sigma^0$ $u(-\frac{1}{2})s(\frac{1}{2})d(-\frac{1}{2})$ EMI* Sigma*(0)	$Ddbar=KIR+KIR-VPE-\bar{K}$ EMI-Decay (-1/2) (m=us: b <sup>+</sup> =ud.ū & b <sup>-</sup> =ūd.u)	$ddd=dD=KKK+IRIRIR$	$ddd=\Delta^+$ $d(-\frac{1}{2})d(-\frac{1}{2})d(-\frac{1}{2})$ EMI Delta(+)
9-18-27	IRA*/ira*	I*PA*/i*ρα*	Yod*-י*	Resh-ר	Aleph*-א*	$dus=sud=\Lambda^0$ $d(-\frac{1}{2})s(\frac{1}{2})u(-\frac{1}{2})$ QGS* Lambda(0)	$Ssbar=KOR+KOR-VPE-\bar{K}$ WNI-Decay (-1/2) (t=ds: t <sup>+</sup> =us.đ & t <sup>-</sup> =ūs.d)	$sss=sS=SS=KKK+OROROR$	$sss=\Omega^-$ $s(-\frac{1}{2})s(-\frac{1}{2})s(-\frac{1}{2})$ WNI Omega(-)

Mathimatia:  $\{3\} \times \{3\} \times \{3\} = 27$  Permutations YCM for 18+9 elementary particles

Quantum Spin  $-\frac{1}{2} + \frac{1}{2} - \frac{1}{2} = -\frac{1}{2}$  QGS = Quantum Geometric Symmetry  $-\frac{1}{2} - \frac{1}{2} - \frac{1}{2} = -\frac{1}{2}$  Quantum Spin

The K-Means define individual materializing families of elementary particles:

- a (UP/DOWN-Mean) sets the (PION-FAMILY:  $\pi^0, \pi^+, \pi^-$ )
- a (STRANGE-Mean) specifies the (KAON-FAMILY:  $K^0, K^+, K^-$ ).
- a (CHARM-Mean) defines the (J/PSI=J/ψ-Charmonium-FAMILY)
- a (BEAUTY-Mean) sets the (UPSILON=Y-Bottonium-FAMILY)
- a (MAGIC-Mean) specifies the (EPSILON=E-FAMILY)
- a (DAINTY-Mean) bases the (OMICRON-O-FAMILY)
- a (TRUTH-Mean) sets the (KOPPA=K-Topomium-FAMILY)
- a (SUPER-Mean) defines the final quark state in the (HIGGS/CHI=H/X-FAMILY)

### {1} Matter interacts with antimatter-based Neutrinos in Majorana-Dirac Electron Capture

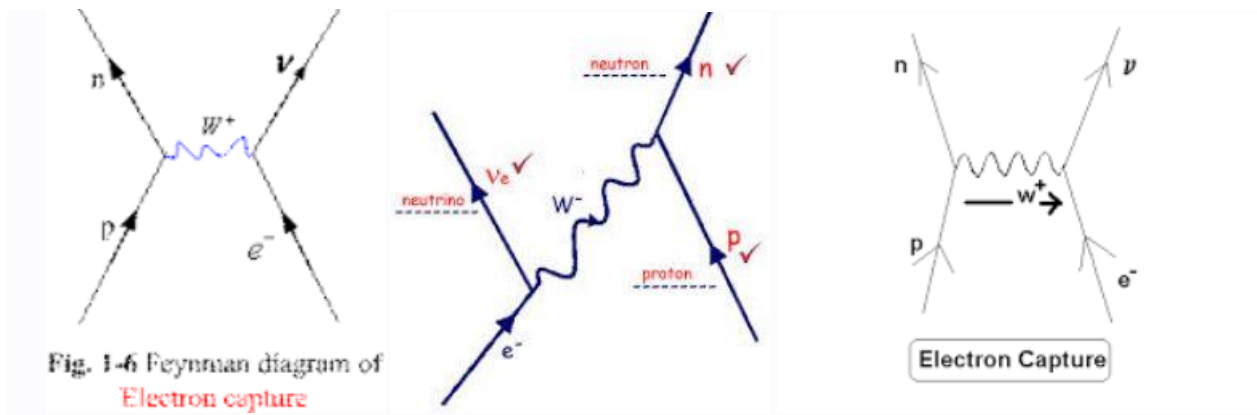

An Electron in the inner atomic nucleus is captured by a proton to create a neutron accompanied by an electron neutrino.

This requires a u-quark of the proton to transform into a d-quark of the neutron. As the d-quark is a KIR quark of inner mesonic ring of electro charge [+2/3] coupled to the MIR of electro charge [-1], a W<sup>-</sup> weakon must be engaged to couple to a left-handed proton via the Nonparity of the weak nuclear interaction. However, in electron capture a left-handed electron neutrino is emitted, requiring the interaction of a W<sup>+</sup> weakon as the kernel gauge for any such right-handed antimatter weak decay.

So should the interacting electron initiate electron capture then a W<sup>-</sup> becomes the bosonic partner for the interaction; but if it is the interacting proton, then a W<sup>+</sup> should become the weak interaction agent to neutralize its positive electric charge with the negative electric charge of the interacting electron.

The interaction of matter and anti-matter in the form of the weak interaction bosons and their associated anti-neutrinos and neutrinos can however be shown to result from a basic kernel-ring interaction of the anti-neutrinos and neutrinos as both Majorana particles and as Dirac particles.

Majorana particles are their own anti-particles allowing identification of right-handed antineutrinos as left-handed neutrinos in the base templated or massless self-state. Dirac particles distinguish right handed anti-neutrinos from left handed neutrinos due their mass and inertia in their native oscillation potential.

For a left-handed proton u[-½]d[+½]u[-½] and a left-handed electron e<sup>-</sup>[-½], the W<sup>-</sup> consisting of a right-handed electron and a right-handed anti-neutrino initiates the KIR-Oscillation from the Anti-Neutrino-Gluon kernel of the up quark in coupling it to the OR part of the W<sup>-</sup>. The colourless Graviphoton, GP or G<sub>γ</sub> rendering the 'virtuality' of the W<sup>-</sup> as physically real in neutralizing the bosonic weakon spin, which 'flips' the right-handed anti-neutrino into a left-handed neutrino observed.

$$\begin{aligned} & \text{Proton } p^+[-\frac{1}{2}] + \text{Electron } e^-[-\frac{1}{2}] \\ \Rightarrow & p^+[-\frac{1}{2}] + \text{OR}^-[-\frac{1}{2}]^* + \{ \text{Electron } e^-[+\frac{1}{2}] + \text{Anti}_{\text{electron}}[+\frac{1}{2}] \}_{W^-} + \text{Graviphoton}[-1] \\ \Rightarrow & d[+\frac{1}{2}]u[-\frac{1}{2}]\{u[-\frac{1}{2}] + \text{IR}^-[0]\}^* \{ \text{KIR-Oscillation (OR-IR)}^0[-\frac{1}{2}] + W^-[+1] + \text{GP}[-1] \} \\ \Rightarrow & d[+\frac{1}{2}]u[-\frac{1}{2}]d[-\frac{1}{2}] + \{ (\text{OR-IR})^0[0] + \text{Anti}_{\text{electron}}[+\frac{1}{2}] + \text{GP}[-1] \} \Rightarrow n^0[-\frac{1}{2}] + \nu_{\text{electron}}[-\frac{1}{2}] \end{aligned}$$

with the KIR-Oscillation transferring the interacting left-handed electron charge -1 without spin in the OR-IR-K for the IR-K up-down quark transformation {+2/3-1=-1/3} and neutralizing the weakon associated intrinsic right-handed electron spin as +½-½=0 for the remaining OR-IR transition.

The neutron is cyclically delinearized from spin self-state d[+½]u[-½]d[-½] into the triplet configuration YCM=CMY=MYC as d[-½]u[+½]d[-½]. A Magneto axis symmetric Proton K(KIR)K transforms into Magneto axis symmetric Neutron KIR(K)KIR as one of the proton's end Kernel up-quarks 'captures' the Weakonic VPE scalar OR<sup>-</sup> Electron Outer Ring in the Unified Field of Quantum Relativity.

It is in fact a W<sup>-</sup>, that interacts, but coupling to the left-handed electron instead of the left-handed proton, the latter requiring some coupling to the W<sup>+</sup> weakon in the quantum field to materialize the electron neutrino from the W<sup>+</sup> template in a direct fashion and not as the Majorana-Dirac 'flip' initiated by the W<sup>-</sup> from before. It is the W<sup>+</sup> intrinsic positron which is 'flipped' to 'free' the materializing neutrino from the W<sup>+</sup> weakon base state.



But as the resultant Outer Ring - Inner Ring remnant  $\{(OR-IR)^+[0]\}$  is positively charged and not charge neutral as was the case for the previous  $W^-$  weakon interaction; the  $W^+$  weakon from the proton is suppressed in electron capture in favour of the  $W^-$  weakon from the electron.

Proton  $p^+[-\frac{1}{2}] + \text{Electron } e^-[-\frac{1}{2}] \Rightarrow$

$p^+[-\frac{1}{2}] + IR[-\frac{1}{2}] + \{(\text{Positron } e^+[-\frac{1}{2}] + v_{\text{electron}}[-\frac{1}{2}])_{W^+} + \text{Graviphoton}[+1]\}$

$\Rightarrow d[+\frac{1}{2}]u[-\frac{1}{2}]\{u[-\frac{1}{2}] + IR^-[0]\} * \{KIR\text{-Oscillation } (OR-IR)^0[-\frac{1}{2}] + e^+[+\frac{1}{2}] + v_{\text{electron}}[-\frac{1}{2}]\}$

$\Rightarrow d[+\frac{1}{2}]u[-\frac{1}{2}]d[-\frac{1}{2}] + \{(OR-IR)^+[0]\} + v_{\text{electron}}[-\frac{1}{2}] \Rightarrow n^0[+\frac{1}{2}] + v_{\text{electron}}[-\frac{1}{2}] + \{(OR-IR)^+[0]\}$

The  $W^-$  then supplies the required KIR for the up-quark to down-quark transmutation with the gauge spin neutralizer of the left-handed Graviphoton  $[-1]$  flipping the right-handed electron antineutrino constituent of the  $W^-$  into its anti-particle form of a left-handed electron neutrino as a Majorana self-state transforming into a Dirac self-state.

Electron capture so displays the Majorana nature of the two base neutrinos of the electron positron and muon-antimuon definition in their massless gauge nature when engaged in the direct interaction or 'tapping' of the UFoQR in the Vortex-Potential-Energy or VPE/ZPE

in  $R^2G^2B^2[+\frac{1}{2}] + B^2G^2R^2[-\frac{1}{2}] = BY^2B[0]=GM^2G[0]=RC^2R[0] = VPE[0]$ .

An Anti-Neutrino template  $R^2G^2B^2[+\frac{1}{2}] = W^2[+\frac{1}{2}] = B^2G^2R^2[-\frac{1}{2}] + GP[+1]$  as Neutrino template in  $E=hf$  radiative 'White'-eigen energy and being undifferentiated between the particle and anti-particle energy eigen state under the application of the spin symmetry of the 'flipping' 'white' Graviphoton.

The Dirac nature of the base neutrinos then can be said to apply to all (anti)neutrinos carrying mass in their oscillation potential and properties exhibited in their wave mechanical dynamics manifested in the Anti-Neutrino template  $R^2G^2B^2[+\frac{1}{2}]$  being the anti-state for the Neutrino template  $B^2G^2R^2[-\frac{1}{2}]$  and without or following the Graviphoton 'flip'.

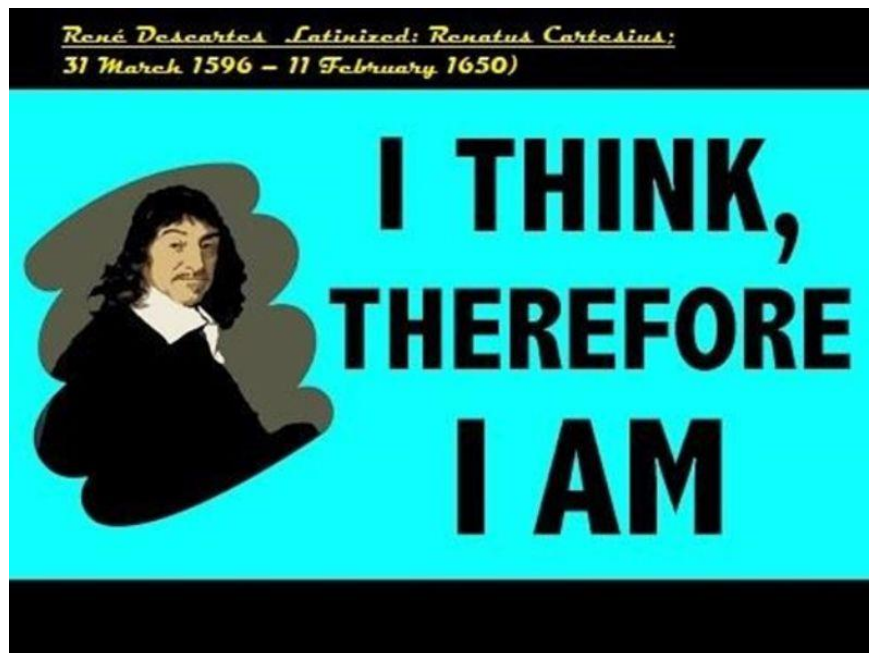

## CP violation in the weak nuclear interaction

The difference between matter and antimatter subsequently derives from the difference between the Outer Ring charge of the  $W^+$  for antimatter and the  $W^-$  for matter and so becomes related to the nature of constituent neutrinos and anti-neutrinos in the Kernel-Ring oscillations respectively.

The described gluon-anti-neutrino-electron oscillation from Kernel to mesonic IR to leptonic OR so becomes an inherent supersymmetry between bosonic gluons and fermionic (anti)neutrinos manifesting in the weak interaction and its associated parity violations in Charge-Parity (CP) symmetry.

All quark-antiquark states engaging outer ring oscillations, such as the neutral kaon pairing  $d.sbar$  and  $dbar.s$  and bottom quark energy states such as  $b.sbar = (ud)bar.sbar =$  so will exhibit a difference between matter and antimatter.

For matter IR with antimatter ORbar, for the neutral kaon  $K^0$  oscillates from its kernel VPE  $K.Kbar$  or  $u.ubar$  a matter IR to an antimatter ORbar for the antimatter weakon:

$$\begin{aligned}
 K^0 &= d.sbar = [K+IR].[Kbar+ORbar] = [K.Kbar][0] + [IR*ORbar][0] \\
 &= [K.Kbar][0] + [IR*\{ORbar+v_{electron}\}[-1]]_{W^+} + Gy[+1] \Rightarrow \{u.ubar+d.dbar \text{ or } u.dbar+ubar.d\} + [-\frac{1}{2}-\frac{1}{2}+1] \\
 &\{\text{strong weak anti-gluon-neutrino kernel-ring interaction suppressing any lepton decay products}\} \\
 &\Rightarrow \{\pi^0+\pi^0 \text{ or } \pi^++\pi^-\} \Rightarrow K_{short}^0 \text{ or} \\
 &\Rightarrow \{ubar.d+e^+[\frac{1}{2}] + v_{electron}[-\frac{1}{2}]\} \Rightarrow \pi^-[0] + e^+[\frac{1}{2}] + v_{electron}[-\frac{1}{2}] \Rightarrow K_{long}^0, \\
 &\text{if the } W^+ \text{ manifests from its quantum geometric VPE structure in an ORbar-IR oscillation.}
 \end{aligned}$$

For antimatter IRbar with matter OR, for the neutral kaon  $K^0bar$  oscillates from its kernel VPE  $K.Kbar$  or  $u.ubar$  an antimatter IRbar to a matter OR for the matter weakon:

$$\begin{aligned}
 K^0 &= dbar.s = [Kbar+IRbar].[K+OR] = [K.Kbar][0] + [IRbar*OR][0] \\
 &= [K.Kbar][0] + [IRbar\{OR+antiv_{electron}\}[+1]]_{W^-} + Gy[-1] \\
 &\Rightarrow \{u.ubar+d.dbar \text{ or } u.dbar+ubar.d\} + \{\text{strong weak gluon-anti-neutrino kernel-ring interaction suppressing any lepton decay products}\}[-\frac{1}{2}-\frac{1}{2}+1] \\
 &\Rightarrow \{\pi^0+\pi^0 \text{ or } \pi^++\pi^-\} \Rightarrow K_{short}^0 \text{ or} \\
 &\Rightarrow \{u.dbar+e^-[\frac{1}{2}] + antiv_{electron}[\frac{1}{2}]\} \Rightarrow \pi^+[0] + e^-[\frac{1}{2}] + antiv_{electron}[\frac{1}{2}] \Rightarrow K_{long}^0, \\
 &\text{if the } W^- \text{ manifests from its quantum geometric VPE structure in an IRbar-OR oscillation.}
 \end{aligned}$$

But an exchange of the inner and outer rings in their matter and antimatter nature is also possible resulting in the super positioning of the neutral kaon's wavefunctions and leading to CP violation in that mixing between matter and antimatter in characteristics defined in the weakon quantum geometry.

Here, the Graviton does not neutralize the interacting weakon spin, but spin induces the interacting mesonic inner ring in the IR-ORbar or IRbar-OR oscillation and delaying the strong weak kernel-ring interactions for the antigluon-neutrino or gluon-anti-neutrino kernel templates respectively.

$$\begin{aligned}
 K^0 &= d.sbar = [K+IR].[Kbar+ORbar] = [K.Kbar][0] + [IR*ORbar][0] \\
 &= [K.Kbar][0] + [IR*\{ORbar + v_{electron}\}[-1]]_{W^+} + Gy[+1] \\
 &\Rightarrow [u.ubar][0] + \{IR^*[+1] + ORbar[-1] + v_{electron}[0]\} \Rightarrow [u.ubar][0] + [KIR.KIRbar][0] \Rightarrow \{u.ubar+d.dbar\} \text{ as a two-} \\
 &\text{particle decay in anti-gluon-neutrino strong weak interaction and with the Graviton}[+1] \text{ spin inducing the matter based Inner Ring to neutralize the opposite spin of the interacting } W^+[-1] \text{ weakon.}
 \end{aligned}$$

$K^0 = \text{dbar.s} = [\text{Kbar} + \text{IRbar}].[\text{K} + \text{OR}] = [\text{K.Kbar}][0] + [\text{IRbar} * \text{OR}][0]$   
 $= [\text{K.Kbar}][0] + [\text{IRbar}\{\text{OR} + \text{antiv}_{\text{electron}}\}[+1]]_{\text{W}^-} + \text{G}\gamma[-1]$   
 $\Rightarrow [\text{u.ubar}][0] + \{\text{IRbar} * [+1] + \text{OR}[-1] + \text{antiv}_{\text{electron}}[0]\} \Rightarrow [\text{u.ubar}][0] + [\text{KIRbar.KIR}][0] \Rightarrow \{\text{u.ubar} + \text{d.dbar}\}$  as a two particle decay in gluon-anti-neutrino strong weak interaction and with the Graviphoton[-1] spin inducing the antimatter based Inner Ring to neutralize the opposite spin of the interacting  $W^- [+1]$  weakon.

The difference in the antimatter to matter and matter to antimatter kernel-ring oscillation so results in the mixing of the wave functions to exemplify the CP violation in the neutral kaon as decaying in different fashion and decay rates as the  $K_{\text{short}}^0 = \{\text{d.sbar} + \text{dbar.s}\}/\sqrt{2}$  and the  $K_{\text{long}}^0 = \{\text{d.sbar} - \text{dbar.s}\}/\sqrt{2}$  in decay times differing in a factor of the light-matter interaction probability  $\alpha$  in  $t_{K_S^0} = 8.95 \times 10^{-11} \text{ s}^*$  in a two particle decay  $\{\pi^0 + \pi^0 \text{ or } \pi^+ + \pi^-\}$  and  $5.18 \times 10^{-8} \text{ s}^*$  in a three particle decay  $\{\pi^0 + \pi^0 + \pi^0 \text{ or } \pi^0 + \pi^+ + \pi^- \text{ or } \pi^+ + e^- + \nu_{\text{electron}} \text{ or } \pi^- + e^+ + \nu$  or similar pion-lepton combinations from the weakon templates} respectively.

This superposition so shows the  $K_{\text{short}}^0$  to engage the  $W^-$  and the  $K_{\text{long}}^0$  to utilize the  $W^+$  in a distinct quantum geometric difference between the kernel-inner ring - outer ring oscillations between that of interacting matter weakons and that of interacting antimatter weakons.

The discovery in 1964 of the  $K_{\text{long}}^0$  also at times manifesting a two-particle decay proved the CP violation at the Brookhaven Alternating Gradient Synchrotron Laboratory by a collaboration led by James Cronin and Val Fitch of Princeton University and extended the original CP symmetry violation found in 1957 by Yang, Lee and Wu. As shown above, this CP violation becomes a consequence of wave-quarkian quantum geometry applied to quantum chromodynamics.

For the neutral B-mesons defined in a diquark structure ( $U = [\text{uu}]$  for  $c = \text{U.ubar}$ ;  $b = [\text{ud}].\text{ubar}$ ;  $t = [\text{ds}].U$ ) detailed further on in this paper, the CP violation at a higher energy level becomes more pronounced and susceptible to the measurement of the manifesting energies.

Because the  $K_{\text{long}}^0$  decay pattern also allows a two particle decay in the form of the mesonic ring part of the b-quark being spin induced by the Graviphoton, instead of the latter spin neutralizing the weakon spin; an excess of the matter based diquark  $b = \text{ud.ubar}$  decay patterns relative to the antimatter based anti-diquark  $\text{bbar} = \text{ud.bar.u}$  will be observed in the experimental evidence in the subtraction of the  $K_{\text{long}}^0$  decay patterns becoming added to the decay patterns of the  $K_{\text{short}}^0$ .

Typical decay patterns for the B-mesons are:

$$\begin{aligned}
 B^- &= b.\text{ubar} = [\text{ud.ubar}].\text{ubar} = [U + \text{IR} + \text{Kbar}].[\text{Kbar}] \\
 &= [\text{K.Kbar}] + [\text{K} + \text{Kbar}] + \{\text{IR}^* - \text{OR}[+1/2] + \text{antiv}[+1/2]\}_{\text{W}^-} + \text{G}\gamma[-1] \\
 &\Rightarrow \text{Uubar} + \text{OR}[-1/2] + \text{antiv}[+1/2] \Rightarrow \text{ucbar}[0] + \text{OR}[-1/2] + \text{antiv}[+1/2] \Rightarrow D^0[0] + (e^-; \mu^-)[-1/2] + \text{antiv}[+1/2]
 \end{aligned}$$

$$\begin{aligned}
 B^+ &= \text{bbar.u} = [\text{udbar.u}].u = [U\text{bar} + \text{IRbar} + K].[K] \\
 &= [\text{K.Kbar}] + [\text{Kbar} + K] + \{\text{IRbar}^* - \text{ORbar}[-1/2] + \nu[-1/2]\}_{\text{W}^+} + \text{G}\gamma[+1] \\
 &\Rightarrow \text{Ubar} + \text{KIRbar}^* - \text{ORbar}[+1/2] + \nu[-1/2] \Rightarrow \text{c.ubar}[0] + \text{ORbar}[+1/2] + \nu[-1/2] \Rightarrow D^0[0] + (e^+; \mu^+)[+1/2] + \nu[-1/2]
 \end{aligned}$$

$$\begin{aligned}
 B_d^0 &= b.\text{dbar} = [\text{ud.ubar}].\text{dbar} = [U + \text{IR} + \text{Kbar}].[\text{KIRbar}] \\
 &= [U.\text{Kbar} + \text{KIRbar}] + \{\text{IR}^* - \text{OR}[+1/2] + \text{antiv}[+1/2]\}_{\text{W}^-} + \text{G}\gamma[-1] \Rightarrow \text{Uubar} + \text{KIRbar} + \text{OR}[-1/2] + \text{antiv}[+1/2] \\
 &\Rightarrow \text{c.dbar} + \text{OR}[-1/2] + \text{antiv}[+1/2] \Rightarrow D^+[0] + (e^-; \mu^-)[-1/2] + \text{antiv}[+1/2]
 \end{aligned}$$

$$\begin{aligned}
B_d^0 &= \text{bbar}.d = [\text{udbar}.u].d = [\text{Ubar}+\text{IRbar}+\text{K}].[\text{KIR}] \\
&= [\text{K}.\text{Kbar}] + [\text{Ubar}.\text{K}+\text{KIR}]+[\text{IRbar}^*-\text{ORbar}[-\frac{1}{2}] + \nu[-\frac{1}{2}]]_{W^+} + G\gamma[-1] \\
&\Rightarrow \text{Ubar}.u+\text{OR}[-\frac{1}{2}] + \text{antiv}[\frac{1}{2}] \Rightarrow \text{cbar}.d + \text{ORbar}[\frac{1}{2}] + \nu[-\frac{1}{2}] \Rightarrow D^-[0] + (e^+;\mu^+)[\frac{1}{2}] + \nu[-\frac{1}{2}]
\end{aligned}$$

For antimatter IR and matter OR, a possible decay mode is:

$$\begin{aligned}
B_s^0 &= \text{bbar}.s = [\text{udbar}.u].s = [\text{Ubar}+\text{IRbar}+\text{K}].[\text{K}+\text{OR}] \\
&\Rightarrow [\text{Ubar}+\text{IRbar}+\text{K}].[\text{K}[0] + (\{\text{OR}+\text{antiv}_{\text{electron}}\}[\frac{1}{2}])_{W^+} + G\gamma[-1]] \Rightarrow [\text{Ubar}+\text{IRbar}+\text{K}].[\text{K}[0] + \text{antiv}_{\text{electron}}[0]] \\
&\Rightarrow ([\text{Kbar}.\text{Kbar}]+\text{K}+\text{IRbar})(\text{K}+\text{OR}) \Rightarrow [\text{Kbar}.\text{K}] + [\text{KIRbar}.\text{KOR}] + \{\text{strong weak kernel-ring gluon-anti-neutrino interaction suppressing any lepton decay products}\} \Rightarrow \text{ubar} + \text{dbar}.s \Rightarrow \pi^0 + K^0 \\
&\Rightarrow [\text{Kbar}.\text{KOR}]+[\text{K}.\text{KIRbar}] \{\text{strong weak kernel-ring gluon-anti-neutrino interaction suppressing any lepton decay products}\} \Rightarrow \text{ubar}.s + \text{udbar} \Rightarrow K^- + \pi^+
\end{aligned}$$

For matter IR and antimatter OR, a possible decay mode is:

$$\begin{aligned}
B_s^0 \text{bar} &= \text{b}.s\text{bar} = [\text{ud}.u\text{bar}].s\text{bar} = [\text{U}+\text{IR}+\text{Kbar}].[\text{Kbar}+\text{ORbar}] \\
&\Rightarrow [\text{U}+\text{IR}+\text{Kbar}].[\text{Kbar}[0] + (\{\text{ORbar}+\nu_{\text{electron}}\}[-\frac{1}{2}])_{W^+} + G\gamma[+1]] \\
&\Rightarrow [\text{U}+\text{IR}+\text{Kbar}].[\text{Kbar}[0] + (\text{ORbar}[0]+\nu_{\text{electron}}[0])] \Rightarrow ([\text{Kbar}.\text{Kbar}]+\text{Kbar}+\text{IR})(\text{Kbar}+\text{ORbar}) \\
&\Rightarrow [\text{Kbar}.\text{K}] + [\text{KIR}.\text{KORbar}] + \{\text{strongweak kernel-ring gluon-neutrino interaction suppressing any lepton decay products}\} \Rightarrow \text{ubar} + \text{d}.s\text{bar} \Rightarrow \pi^0 + K^0 \\
&\Rightarrow [\text{K}.\text{KORbar}] + [\text{Kbar}.\text{KIR}] \{\text{strongweak kernel-ring gluon-neutrino interaction suppressing any lepton decay products}\} \Rightarrow \text{u}.s\text{bar} + \text{ubar}.d \Rightarrow K^+ + \pi^-
\end{aligned}$$

The neutral kaon  $K^0$  d.sbar-dbar.s quark content superposition repeats the CP violation as indicated.

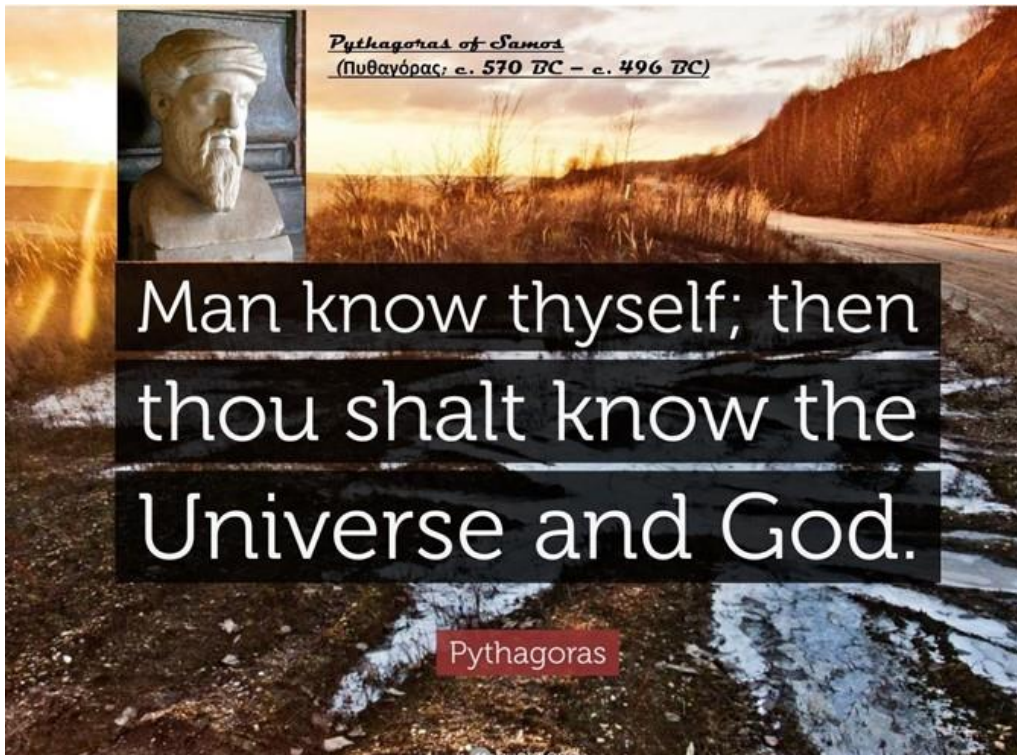

## {2} Matter interacts with matter based Anti-Neutrinos via superposed VPE-Weakon Action

Protons transform into neutrons with antimatter positrons and where the interacting anti-neutrino as constituent part of the  $W^-$  weakon induces Pair-Production for weakon's electron in tapping the VPE to manifest a like spinning positron to neutralize the boson spin of the Graviphoton. The spin of the Graviphoton so cancels the spin of the Pair-Production VPE as well as the spin of the weakon boson in a superposition of the VPE and the weak interaction.

A up quark of the proton then changes into a down quark for the produced neutron in a double transition from the Outer Ring of the weakon's electron transiting to the Inner Ring and the original anti-neutrino transits from the Inner Ring onto the Gluon-Neutrino kernel K as the decay products of a free neutron. The right-handed spin quantum of the anti-neutrino cancels the left-handed quantum spin of the weakon's electron base which was flipped by the Graviphoton for the MIR oscillation between the up quark and the down quark transformation.

{Mass produced photons (by acceleration of inertia coupled electro charges), have no magneto charge and so form their own anti-particles; whilst gauge or 'virtual' photons carry cyclic and anticyclic colour charges as consequence of the matter-antimatter asymmetry}.

Proton  $p^+[-\frac{1}{2}] + \text{Antiv}_{\text{electron}}[+\frac{1}{2}]$

$\Rightarrow p^+[-\frac{1}{2}] + \{\text{Antiv}_{\text{electron}}[+\frac{1}{2}] + (\text{Electron } e^-[+\frac{1}{2}])_{W^-} + \text{Positron } e^+[+\frac{1}{2}]_{\text{VPE}^0_{[+1]}} + \text{Graviphoton}[-1]\}$

$\Rightarrow p^+[-\frac{1}{2}] + \{\text{Electron } e^-[-\frac{1}{2}] + \text{Antiv}_{\text{electron}}[+\frac{1}{2}]\} + \text{Positron } e^+[+\frac{1}{2}]$

$\Rightarrow \{p^+[-\frac{1}{2}] + \text{IR}^-[0] + K^0[-\frac{1}{2} + \frac{1}{2}]\} + e^+[+\frac{1}{2}] \Rightarrow n^0[-\frac{1}{2}] + e^+[+\frac{1}{2}]$

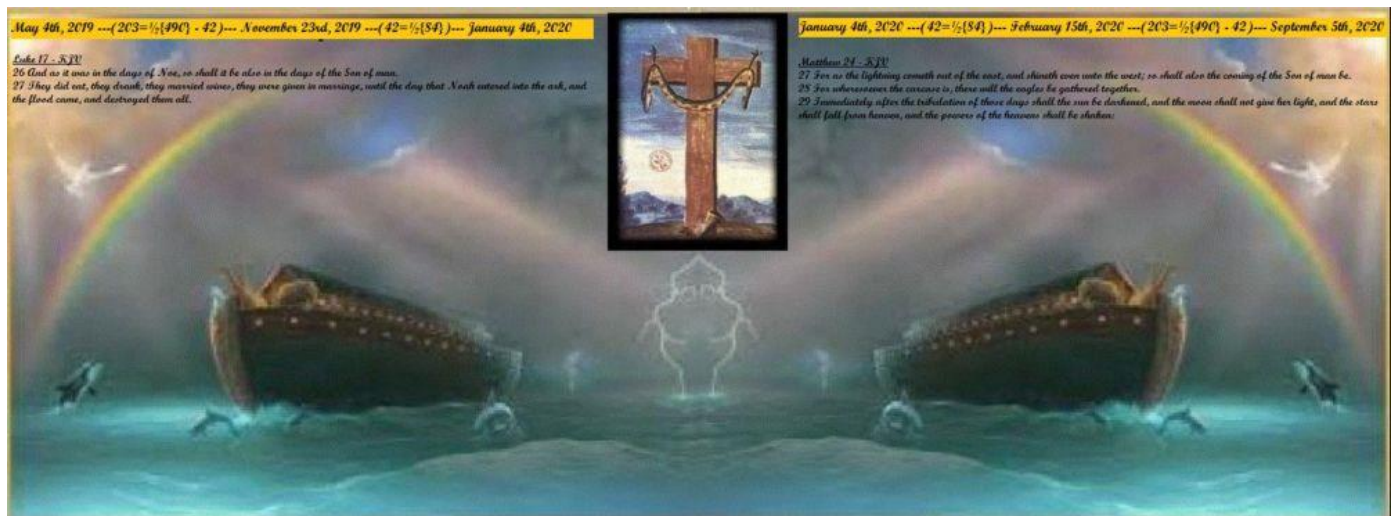

### {3} Matter interacts with antimatter-based Neutrinos via Unified Weakon Action {OR+Antiv=W<sup>-</sup>;v+Anti-OR<sup>+</sup>=W<sup>+</sup>}

Neutrons transform into protons with muons, the latter decaying into electrons and anti-neutrinos and neutrinos, so reducing the elementary matter-neutrino interaction to basic neutron beta minus-decay with the leptonic coupling between the 'resonance electron' as a basic muon coupled to its neutrino. A neutron's down quark transforming into a up quark in disassociating the mesonic Inner Ring part of the down quark from its up-quark kernel part to become the leptonic Outer Ring part of the manifesting muon. The interacting muon neutrino couples with the antineutrino of the weakon template as its own anti particle transferring its mass to the muon and changing its self-state from mass defined Diracness to massless Majorananness in the process.

$$\begin{aligned}
 & \text{Neutron } n^0[-\frac{1}{2}] + \nu_{\text{muon}}[-\frac{1}{2}] \Rightarrow n^0[-\frac{1}{2}] + \nu_{\text{muon}}[-\frac{1}{2}] + (\{\text{Antiv}_{\text{muon}}[+\frac{1}{2}] + (\text{Muon } \mu^-[+\frac{1}{2}])_{W^-} + \text{GP}[-1]\}) \\
 & \Rightarrow d[-\frac{1}{2}]u[+\frac{1}{2}]d[-\frac{1}{2}] + * \{ \text{KIROR-Oscillation (OR-IR-K)}[+\frac{1}{2}] + \text{Antiv}_{\text{muon}}[+\frac{1}{2}] + \nu_{\text{muon}}[-\frac{1}{2}] + \text{GP}[1] \} \\
 & \Rightarrow d[-\frac{1}{2}]u[+\frac{1}{2}]u[-\frac{1}{2}] + \text{IR}[0] + \{ \text{OR}^-[+\frac{1}{2}] + \text{GP}[-1] \} + \{ R^2 G^2 B^2[-\frac{1}{2}] + B^2 G^2 R^2[+\frac{1}{2}] \} \Rightarrow p^+[-\frac{1}{2}] + \mu^-[-\frac{1}{2}] + \text{VPE}[0] \\
 & \Rightarrow p^+[-\frac{1}{2}] + \mu^-[-\frac{1}{2}] + \text{VPE}[0] \\
 & \Rightarrow p^+[-\frac{1}{2}] + * \{ \text{KIROR-Oscillation (OR-IR-K)}[-\frac{1}{2}] \} (\{ e^-[+\frac{1}{2}] + \text{Antiv}_{\text{electron}}[+\frac{1}{2}] \}_{W^-} + \text{GP}[-1]) \\
 & \Rightarrow p^+[-\frac{1}{2}] + \nu_{\text{muon}}[-\frac{1}{2}] + e^-[-\frac{1}{2}] + \text{Antiv}_{\text{electron}}[+\frac{1}{2}]
 \end{aligned}$$

In the muon beta decay, the KIROR oscillation transfers the spin of the interacting muon as the spin of its self-state neutrino and enabling the constituents of the matter weakon W<sup>-</sup> to manifest with the right-handed electron part flipping to manifest the left-handed electron of the beta decay.

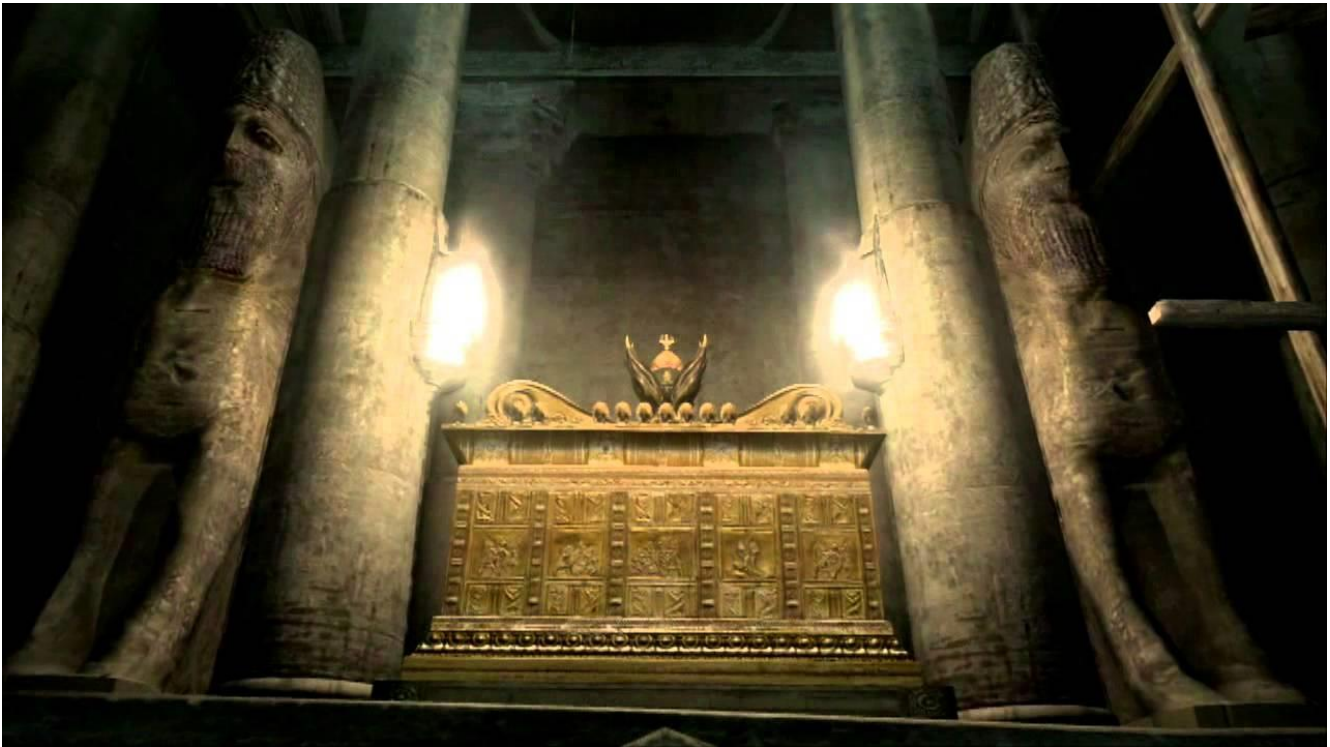

## XII: The Gravitational Constant, the Alpha Finestructure Constant and the GUT-Monopole

$$G_0 X^{np} (1 + ec/30ec + 1/e^*) = G_0 X^{np} \{1 + 1/30 + 1/e^*\} = (6.44221014 \times 10^{-11}) \{31/30 + 1/500\} = 6.66983490 \times 10^{-11} \text{ [m}^3/\text{kgs}^2\text{]}^* = 6.67445232 \times 10^{-11} \text{ [m}^3/\text{kgs}^2\text{]}_{SI} \text{ for the unitary calibration [m}^3/\text{kgs}^2\text{]}^* = 1.000692286 \text{ [m}^3/\text{kgs}^2\text{]}_{SI}$$

{s} <sub>SI</sub>	=	1.000978394	{s*}	=	0.999022562	{s} <sub>SI</sub>
{m} <sub>SI</sub>	=	1.001671357	{m*}	=	0.998331431	{m} <sub>SI</sub>
{kg} <sub>SI</sub>	=	1.003753126	{kg*}	=	0.996260907	{kg} <sub>SI</sub>
{C} <sub>SI</sub>	=	1.002711702	{C*}	=	0.997295631	{C} <sub>SI</sub>
{J} <sub>SI</sub>	=	1.005143377	{J*}	=	0.994882942	{J} <sub>SI</sub>
{eV} <sub>SI</sub>	=	1.00246560	{eV*}	=	0.997540464	{eV} <sub>SI</sub>
{K} <sub>SI</sub>	=	0.98301975	{K*}	=	1.017273559	{K} <sub>SI</sub>

The variation observed in the experiments to measure the gravitational constant G(n) therefore depend not on the time variation decrease for G(n), which is precisely balanced in the time variation increase of the M(n) factor in the gravitational parameter, but is a mirror effect of the universal pole direction variation in the alpha finestructure constant, given as  $\Delta\alpha/\alpha = 8.08 \times 10^{-5}$  and as the effect of the Dirac string connecting the three wormholes of the QBBS instanton-inflaton couplings quantum entangling the Riemann-Baab universe with the Abba-Khaibit shadow universe in the definitions of the string-membrane modular T-Mirror dualities.

Alpha remains constant for a cosmology descriptive of a non-accelerating cosmology; but will result in a change in the electric charge quantum in a cosmology, which measures an accelerated spacial expansion, which is however the result of a self-intersection of the light path for particular cosmological redshift intervals in an oscillating cosmology.

Here a particular alpha variation reduces the SI-measurement for the square of the charge quantum e in a factor of  $(1.6021119 \times 10^{-19} / 1.60217662 \times 10^{-19})^2 = 0.99991921 \dots$  for a calibrated alpha variation

$$\begin{aligned} \alpha_{var} &= 1 - (1.602111895 / 1.60217662)^2 = 1 - 0.9999192 = 8.08 \times 10^{-5} \text{ with Alpha } \alpha = \mu_0 c e^2 / 2h = e^2 / 2\epsilon_0 h c \\ &= 2\pi(2.99792458)(1.602111895)^2 \times 10^{-37} / (6.62607004 \times 10^{-34}) = 60\pi e^2 / h \\ &= 7.296762965 \times 10^{-3} = 1/137.0470721. \end{aligned}$$

As the electropolar charge quantum appears squared in the Alpha-Constant, the Alpha-variation so becomes (1.0000807), with the old value of (e') exceeding the new value of (e) in so 4 parts in 100,000 and [Alpha]' greater in magnitude than Alpha by 81 parts in a million and in agreement with the Churchill-Webb measurements of 1998 and the more recent measurements from by the Wilczynska-Webb-Bainbridge-Barrow-Bosman collaboration (Published 2020), observing very distant quasars with redshifts from quasar J1120+0641 with z=7.085 for an alpha variation

$$\Delta\alpha/\alpha = (\alpha_z - \alpha_0)/\alpha_0 = (-2:18 \pm 7:27) \times 10^{-5}. \quad \text{https://advances.sciencemag.org/content/6/17/eaay9672}$$

The variation in the laboratory measurements of Newton's gravitational constant  $G$  is the combined effect of the monopole mass, which when added with the inverse of the magnetic charge quantum defining the Dirac monopole, but as the proportionality connecting the electropolar charge to the magnetopolar charge from  $e^*E_{ps} = 1 = \{e^*/2e\nu\alpha\}\{m_{\text{electron}}/m_{\text{planck}}\}$ , increases the decreasing  $G(n) = G_0X^n$

The nucleon mass  $m_c(n) = m_cY^n$  compensates for the constancy of  $G_0m_0 = G(n)m(n)$  by one magnetic monopole mass  $m_m = [ec]$  with the source energy perturbation.

Inverting the proportionality  $\{2e\nu\alpha\} = e^*\{m_{\text{electron}}/m_{\text{planck}}\}$  for the proportionality constant as a function of alpha gives  $2\nu\alpha = \{e^*/e\}\{m_{\text{electron}}/m_{\text{planck}}\}$  with  $\{2\nu\alpha\}/\{2e^*\nu\alpha\} = E_{ps}$

Using proportionality constant  $(2\nu\alpha/300)$  to account for the proportionality  $1+1/30 = 31/30 = 310/300$  instead of  $E_{ps}$  as the perturbation  $E_{ps}-2\nu\alpha/300=1.43052605 \times 10^{-3}$  in  $G(n_{\text{present}}) = G(n_p)$

$G(n_p) = G_0X^{n_p}\{31/30+1.43052605 \times 10^{-3}\} = (6.44221014 \times 10^{-11})\{1.03476386\} = 6.666123 \times 10^{-11} [\text{m}^3/\text{kgs}^2]^*$   
 $= 6.67073786 \times 10^{-11} [\text{m}^3/\text{kgs}^2]_{\text{SI}}$  differing from the full perturbation by  
 $(6.67445232 \times 10^{-11} - 6.67073786 \times 10^{-11}) [\text{m}^3/\text{kgs}^2]_{\text{SI}} = 3.7144565 \times 10^{-3} [\text{m}^3/\text{kgs}^2]_{\text{SI}}$  or so 4 parts per 1000

Using Dirac's quantization condition as proportionality  $E_{ps}-(2\alpha/300)=1.95135491 \times 10^{-3}$  gives

$G(n_p) = (6.44221014 \times 10^{-11})\{1.03528469\}=6.66952152 \times 10^{-11} [\text{m}^3/\text{kgs}^2]^* = 6.67413873 \times 10^{-11} [\text{m}^3/\text{kgs}^2]_{\text{SI}}$   
differing from the full perturbation by  
 $(6.67445232 \times 10^{-11} - 6.67413873 \times 10^{-11}) [\text{m}^3/\text{kgs}^2]_{\text{SI}} = 3.135873 \times 10^{-4} [\text{m}^3/\text{kgs}^2]_{\text{SI}}$  or so 3 parts per 10,000

And using the nature of the Action Law as the square of charge for a proportionality constant  $E_{ps}-(2\nu\alpha/300)^2=E_{ps}-(4\alpha/90,000)=1.99967570 \times 10^{-3}$  results in

$G(n_p) = (6.44221014 \times 10^{-11})\{1.03533301\}=6.66983281 \times 10^{-11} [\text{m}^3/\text{kgs}^2]^* = 6.67445024 \times 10^{-11} [\text{m}^3/\text{kgs}^2]_{\text{SI}}$  differing from the full perturbation by  
 $(6.67445232 \times 10^{-11} - 6.67445024 \times 10^{-11}) [\text{m}^3/\text{kgs}^2]_{\text{SI}} = 2.07907 \times 10^{-6} [\text{m}^3/\text{kgs}^2]_{\text{SI}}$  or so 2 parts per Million

Because the source energy quantum  $E_{\text{weyl}} = E_{ps} = m_{ps}c^2 = 1/e^* = (1/2e\nu\alpha)\{m_{\text{electron}}/m_{\text{planck}}\}$ , the direct proportionality between electro charge quantum  $e$  and magneto charge quantum  $e^*$  for the magnetic flux  $\phi_m = (m_{ps}/[ec]_{\text{mod}})ec^3 = E_{ps}=1/e^*$  modifies the gravitational parameter in the basic Schwarzschild metric  $r_{\text{curv}} = 2G_0M/c^2$

The distribution of the 30 GUT monopoles maximizes the minimum condition for a single monopole in the distribution of 30 monopoles in the doubling of the gravitational parameter from the gravitational potential energy  $GMR/R^2 = -\nabla\Phi$  in 4-dimensional spacetime to the gravitational parameter for of a Schwarzschild Black Hole in 5-dimensional spacetime  $2G_0M = G_0\{\Sigma M\} = \{G_0/[ec]\}\{1+1/30+\dots+1/30\}$  for the GUT unification in the timespace preceding the QBBS.

This occurs at the unification mass scale for the fine structures

$\alpha_{\text{EMR}} = 2\pi k_e e^2/hc = 2\pi G_0 m_m^2/hc = \alpha_{\text{GR}}$  and requiring 30 't Hooft-Polyakov magnetic monopoles in the definition of the Maxwell constant  $\mu_0 \epsilon_0 = 1/c^2$  in units  $[\text{Js}^2/\text{C}^2\text{m}][\text{C}^2/\text{Jm}]$  with the condition  $k_e e^2 = G_0 m_m^2 = G_0 [ec]^2$  for unitary consistency  $[k_e] = [\text{Jm}/\text{C}^2] = [\text{Js}/\text{C}^2][\text{m}/\text{s}] = [\text{Action } h/\text{Charge } \text{C}^2][\text{c}]$  with  $G_0 = [e^*/\text{kg}] = [\text{m}^3/\text{kgs}^2] = [\text{Js}/\text{kg}^2][\text{m}/\text{s}] = [h/(ec)^2][\text{m}/\text{s}] = [h/\text{C}^2][\text{s}/\text{m}] = [h/\text{C}^2][1/\text{c}]$  for the reciprocity of lightspeed  $c$  as the invariant constant relating the electropolar charges and fields to their magnetopolar counterparts in modular duality-inversion properties of the Action Law as  $[\text{Charge } \text{C}^2 = \text{Action } h]$ .



The units of the Action Law allow a definition for the 'bare' electron mass as:  $m_e = 30e^2/cR_e \text{ kg}^*$

$[C^2] = [h] = [Js] = \text{kgm}^2/\text{s}$  for  $[\text{kg}] = [C^2\text{s}/\text{m}^2]$  for 30 monopole masses as a GUT monopole mass.

This also defines  $k_e[e^2] = m_m^2/k_e$  for  $m_m^2 = k_e^2[e^2] = [e/4\pi\epsilon_0]^2 = [120\pi ec/4\pi]^2 = [30ec]^2 = m_m^2$  from the Maxwell constant  $\epsilon_0\mu_0 = \{1/120\pi c\}\{120\pi/c\} = 1/c^2$  for the unification condition for the mass of a boundary 't Hooft-Polyakov magnetic monopole to be  $30[ec] \text{ kg}^*$  or  $30[ec]c^2$  Joules of monopolar energy.

A single 't Hooft-Polyakov monopole would have a mass of

$m_{\text{monopole}} = [ec]_{\text{mod}} = 4.819369032 \times 10^{-11} \text{ kg}^*$  for a GUT string unification energy of  $4.3374321288 \times 10^7 \text{ J}^*$  or  $2.7 \times 10^{16} \text{ GeV}^*$ .

All 30 't Hooft-Polyakov monopoles would have a mass of for a GUT string unification energy of  $1.30122964 \times 10^8 \text{ J}^*$  or  $8.1 \times 10^{17} \text{ GeV}^*$ .

For a mass less universe with no magnetic monopoles, the Schwarzschild metric would take the form with a gravitational constant  $G_o$  defining the curvature as a function of purely electromagnetic mass

$r_{\text{curv}}c^2 = G_o\{1+0\}M = G_oM = M/k_e = 4\pi\epsilon_0M$  and where  $M$  would be expressed in terms of a Maxwell's displacement current  $[ec]_{\text{mod}} = \text{current} \times \text{displacement}$ .

Group Period	1	2	3	4	5	6	7	8	9	10	11	12	13	14	15	16	17	18
1	1 H																	2 He
2	3 Li	4 Be											5 B	6 C	7 N	8 O	9 F	10 Ne
3	11 Na	12 Mg											13 Al	14 Si	15 P	16 S	17 Cl	18 Ar
4	19 K	20 Ca	21 Sc	22 Ti	23 V	24 Cr	25 Mn	26 Fe	27 Co	28 Ni	29 Cu	30 Zn	31 Ga	32 Ge	33 As	34 Se	35 Br	36 Kr
5	37 Rb	38 Sr	39 Y	40 Zr	41 Nb	42 Mo	43 Tc	44 Ru	45 Rh	46 Pd	47 Ag	48 Cd	49 In	50 Sn	51 Sb	52 Te	53 I	54 Xe
6	55 Cs	56 Ba	57 La *	72 Hf	73 Ta	74 W	75 Re	76 Os	77 Ir	78 Pt	79 Au	80 Hg	81 Tl	82 Pb	83 Bi	84 Po	85 At	86 Rn
7	87 Fr	88 Ra	89 Ac *	104 Rf *	105 Db	106 Sg	107 Bh	108 Hs	109 Mt	110 Ds	111 Rg	112 Cn	113 Nh	114 Fl	115 Mc	116 Lv	117 Ts	118 Og
				58 Ce *	59 Pr	60 Nd	61 Pm	62 Sm	63 Eu	64 Gd	65 Tb	66 Dy	67 Ho	68 Er	69 Tm	70 Yb	71 Lu	
				90 Th *	91 Pa	92 U	93 Np	94 Pu	95 Am	96 Cm	97 Bk	98 Cf	99 Es	100 Fm	101 Md	102 No	103 Lr	

[\(12\) \(PDF\) Monatomic Superconductivity in the Alchemy of the Stability of the Nucleus | Anthony P Bermanseder - Academia.edu](#)

## An Evolution of the Universe in an oscillating spacetime and the Age of the Earth

Newton's gravitational constant so can vary and decrease over time as a function of the change in the universal inertia increasing in direct proportionality and the transformation of source energy into physically expressed units of quantum consciousness in the gravitational parameter  $GM=G_0M_0=G(n)M(n)$  and  $n$  a dimensionless cycle time. Cycle time parameter  $n$  is defined in  $n=H_0t=ct/R_H$  defining the invariant light path  $X=ct$  as a scale factor for the size of the universe defined at cycle time coordinate  $n$  in a nodal minimum Hubble constant  $f_{\text{weyl}}$ , defined as the instanton of creation and varying between odd and even nodes for a maximized Hubble constant  $H_0=dn/dt$  as the inflaton of creation in the first semi-oscillation of protoverse as a first seedling universe.

An electromagnetic return of the source light traversing the light path  $X=ct$  in the 11-dimensional and higher-dimensional universe so gives birth to a second, but concurrent universe within the omniverse as a multiverse after the completion of the light path of creation has reached the nodal boundary set at the instanton of the Weyl wormhole frequency in the cosmology of the Quantum Big Bang.

The electromagnetic monopolar source light so both reflects and refracts its path from the maximized Hubble  $H_0$ -boundary of the inflaton. The refracted light path then increases the size of the bounding omniverse in the addition of wormhole quanta defined in the quantum of universal consciousness and the light path reflected from the 11-dimensional Witten spacetime mirror retraces the light path travelled from the instanton node to the inflaton node as the initial boundary conditions of the multi-dimensional cosmology.

The lower dimensional expansion of the universe so is continually decelerating in a parametrization of the wormhole parameters applied to the multitudinous form of the volumars occupying the 10 dimensional string universe; but the electromagnetic retracing of the original light path will intersect itself and cause the measurements of cosmological expansion as a redshift of the light observed to appear as a cosmological contraction and a contraction which will also be observed as a universe accelerating its own expansion.

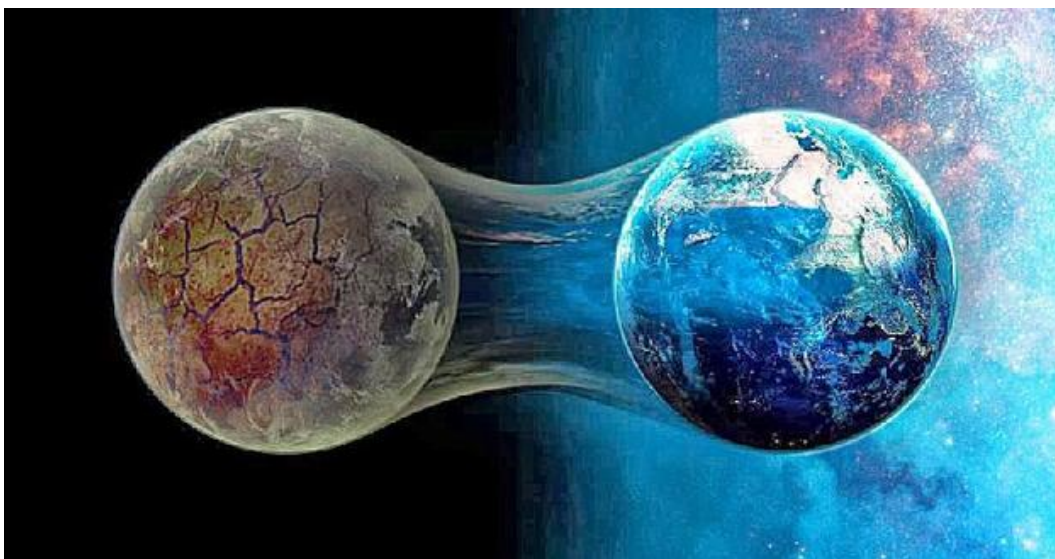

At a present cycle time of  $n=1.1327127\dots$  and a nodal  $n=1$  for  $t_{\text{present}}=1/H_0$ , the electromagnetic return of the monopolar light path has retraced 13.271 % of the Hubble event horizon defined in  $R_H=ct=c/H_0$  of about 16.9 billion light years for a fraction of 2.24 billion light years indicating that the electromagnetic monopolar age of the universe is  $16.876+2.240=19.116$  billion light years; but that this will be measured in the gravitationally decelerating cosmology as  $19.12-4.48=14.64$  billion light years.

As the age of the earth is near the doubled light path of the self-intersection in 4.48 billion years added to a doubled interval of a variation in the alpha finestructure constant in 28.6 million years, the age of the earth is  $4.48+0.056=4.536$  billion years.

Alpha remains constant for a cosmology descriptive of a non-accelerating cosmology; but will result in a change in the electric charge quantum in a cosmology, which measures an accelerated spacial expansion, which is however the result of a self-intersection of the light path for cosmological redshift intervals in an oscillating cosmology.

Here a particular alpha variation reduces the SI-measurement for the square of the charge quantum  $e$  in a factor of  $(1.6021119 \times 10^{-19} / 1.60217662 \times 10^{-19})^2 = 0.99991921\dots$  for a calibrated:

alpha variation  $\alpha_{\text{var}} = 1 - (1.602111895 / 1.60217662)^2 = 1 - 0.9999192 = 8.08 \times 10^{-5}$  with

Alpha  $\alpha = \mu_0 c e^2 / 2h = e^2 / 2\epsilon_0 h c = 2\pi(2.99792458)(1.602111895)^2 \times 10^{-37} / (6.62607004 \times 10^{-34}) = 60\pi e^2 / h = 7.296762965 \times 10^{-3} = 1/137.0470721$ .

As the electropolar charge quantum appears squared in the Alpha-Constant, the Alpha-variation so becomes (1.0000807), with the old value of ( $e'$ ) exceeding the new value of ( $e$ ) in so 4 parts in 100,000 and [Alpha]' greater in magnitude than Alpha by 81 parts in a million and in agreement with the Churchill-Webb measurements of 1998, increasing from Alpha  $= \mu_0 c \cdot e^2 / 2h = 1/137.047072$  to Alpha  $= 1/137.036003$ .

The age of the Milky Way galaxy can be determined by using the process of nucleosynthesis in the early universe in the physics of nucleochronology, that is in measuring the abundance of radioactive elements, such as Thorium-232 (98.98%) compared to the abundance of a known abundance of another stable chemical element found in the periodic table of the atomic elements, such as Europium-153(52.2%); Europium-151(47.8%) is unstable with a half-life of  $5.10 \times 10^9$  Gy.

In the early universe only rapid neutron capture occurred to synthesize the heavier elements. Spectroscopic evidence of absorption spectra for the ultra-metal-poor and massive Galactic Halo Star CS 22892-052 has discovered an abundance of the radioactive element Thorium with half-life 14.05 Gy in  $N(t_{\text{mean}}) = N_0 \cdot \exp[-14.05/t_{\text{mean}}]$  for a mean lifetime of  $t_{\text{mean}} = t_{1/2} / \ln 2 = 14.05 / \ln 2 = 20.27$  Gy.

This larger age is comparable to the Electromagnetic Monopolar EMMI age of the QBBS; but ignores the chemical evolution of the universe adding the reactive elements Europium and Thorium in varying proportions by the rapid neutron capture process to their universal abundance in the subsequent thermodynamic evolution of the universe. The chronometric age determination for CS 22892-052 then provides an estimate of the age for the Milky Way Galaxy and its globular cluster stars.

At the time of the creation of the solar system 4.6 Gy ago, the Thorium/Europium ratio is measured today as 0.369 but as 0.219 in globular cluster star CS 22892-052 in  $N(t) = N_0(t_0) \{2^{-t/t_{1/2}}\}$ .

The {Th/Eu} is  $(0.369) = N_0 \cdot 2^{-[4.6/14.05]}$  for  $N_0 = 0.463$ , substantially higher than that for globular cluster star CS 22892-052 measured as 0.219, indicating a far greater age for the star, then calculated for the abundance ratio in the much younger universe for a  $N_0 = (0.219) \cdot 2^{[4.6/14.05]} = 0.275$ .

And for the mean lifetime  $t_{\text{mean}} = t_{1/2} / \ln 2 = 20.27$  GY:

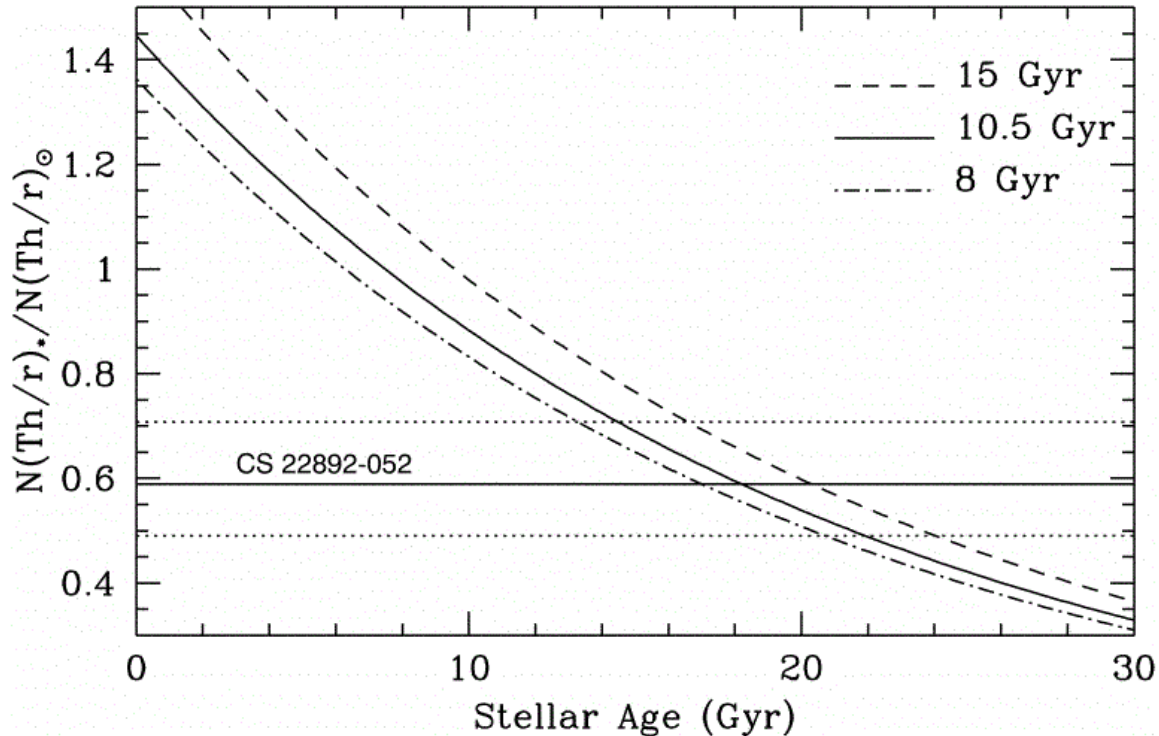

FIG. 8.—Age dependence of the observed Th/r ratio (in units of the observed solar system value), based on a simple model of chemical evolution and three different assumed ages for the Galactic disk. Galactic disk ages of 8, 10.5, and 15 Gyr are indicated. The horizontal lines represent the observed Th/r ratio in CS 22892-052 with  $1\sigma$  uncertainty; the best-fit age is 18 Gyr, with an acceptable range from 14 to 22 Gyr.

<https://iopscience.iop.org/article/10.1086/303968/fulltext/> John J Cowan et al; The Thorium Chronometer in CS 22892-052: Estimates of the Age of the Galaxy; Astrophysical Journal; THE ASTROPHYSICAL JOURNAL, 480:246–254, 1997 May 1

In an earlier paper, addressing the actinide chronometer production ratios for the rapid-neutron capture process derive an age for the Milky Way galaxy of 20.8 [+2/-4] Gy and an age for the universe of 19.5 [+3/-3] Gy for a (Sandage) Hubble constant of 60 km/Mpc.s .

Those calculations concur with the EMMI age of the universe as 19.12 Gy for a nodal Hubble constant of 58.04 km/Mpc.s for a not accelerating universe with zero cosmological constant in the Friedmann-Walker cosmology.

**Title:** New actinide chronometer production ratios and the age of the Galaxy

**Authors:** Thielemann, F.-K., Metzinger, J., & Klapdor, H. V.

**Journal:** Astronomy and Astrophysics (ISSN 0004-6361), vol. 123, no. 1, June 1983, p. 162-169.

<http://articles.adsabs.harvard.edu/full/1983A%26A...123..162T>

Measuring Alpha even further back towards the Quantum Big Bang with increasing redshift, would better approximate the 80 parts per million increases in Alpha from say lower deviations at the say 8 parts per million at lower redshifts. So, the Alpha-Dip indicates that the textbook SI-value for the electropole is fractionally too high; but that the Alpha Finestructure Constant remains indeed constant once the variation in the electronic charge quantum is considered.

Because the magnetic permeability constants are numerically the same in both the (SI) and the (\*) unitary measurement systems; but  $\epsilon_0 = 1/120\pi c = 8.841941283 \times 10^{-12}$  (F/m)\* and is  $\epsilon_0 = 8.8541878176 \times 10^{-12}$  F/m (SI), the (SI) measurement is too large by a factor of 1.00138505 to correlate correctly with the magnetic permeability constant  $\mu_0$  to give the Maxwell constant  $\mu_0 \times \epsilon_0 = (120\pi/c) \cdot (1/120\pi c) = 1/c^2$ .

In the attempt to explain the Alpha-Dip, some theorists have proposed a 'slowing down' of (c). Recent formulations by populist physicist Paul Davies and in co-authorship with Tamara Davis and Charles Lineweaver from the Department of Astrophysics at the University of New South Wales, Sydney, Australia have followed the wrong avenues for the interpretation of the data, however. In a paper published in ('Nature': 'Black Holes constrain varying constants'; August 8th, 2002), the authors propose a varying light speed to be responsible for the Alpha-Dip and discount any possible variation in the electrocharge quantum. Davies' argument that an increase in (e) would alter the evolution of Black Holes in their entropy definitions does not consider that a product of the Boltzmann Constant (defining entropy), with (e) forms a fundamental fine-structured constant.

with  $T^2(n) = 1 = X(X+1) = -i^2 = -XY$  in the Feynman-Path-Integral as alternative quantum mechanical formulation for the equations of Schrödinger, Dirac and Klein-Gordon by:  $T(n) = n(n+1) = |-n| + \dots + |-3| + |-2| + |-1| + 0 + 1 + 2 + 3 + \dots + n$

$$B(n) = \frac{2e}{hA} \cdot \exp[-\text{Alpha} \cdot T(n)]$$

(Universal Cosmic Wavefunction or IEMR=Inverse-Energy-Magnetocharge-Relation for Superstring HE(8x8))

Aleph-Null:  $\lim_{n \rightarrow \infty} (T(n)) = \infty$

Aleph-All:  $\lim_{n \rightarrow -\infty} (T(n)) = 1$

$$|X+Y| = |XY| = -i^2 = 1$$

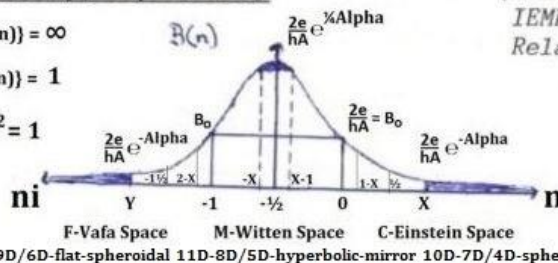

The universe is 'frozen' in M-Space at the X-coordinate for which  $T(n)=1$  and imaged in the Y-coordinate as imaginary time  $n_i$  as function  $B(n)$

$T(n) = n(n+1)$  defines the summation of particle histories (Feynman) and  $B(n)$  establishes the  $v/c$  ratio of Special Relativity as a Binomial Distribution about the roots of the  $XY = i^2$  boundary condition in a complex Riemann Analysis of the Zeta Function about a 'Functional Riemann Bound'  $FRB = -\frac{1}{2}$ .

In particular, the universe's wavefunction  $B(n)$  is localized in any arbitrary spacetime in 'unfreezing' the M-space 'stuck' in between the (X,Y) coordinates and subsequently in between real and imaginary linearized time parameters. This demands the establishment of a Mean-Alignment-Time or MAT, relative to an 'unfreezing definition' in a specification of the 'naked singularity', oscillating as zero-point about the FRB.

As  $E \cdot e^* = E_{ps} \times 1/E_{ps} = 1$  as fundamental unity in the 11D Membrane-Mirror-Space of modular duality with  $e^*$  the magneto charge; one can heuristically state that (Energy  $E \times$  charge quantum  $e$ ) in the lower dimensional C-Line-Space  $C$  can be expressed as the inversed identity in the form of  $1/T$ .

This then sets  $E \cdot e = k_B T e = 1$  for  $[ek_B] = 1/T$  and using an inverse proportion for mass in the lower dimensionality:  $[e^* k_B^*] = 1/T^*$  sets a function  $f(n) = [ek_B]/[e^* k_B^*] = [T^*/T]$ .

This is the case for the Mass-Temperature inverse proportionality for the evolution of Black Holes from microstates to macro states and as in the Hawking Mass-Temperature relation for Black Holes and relabeling the Weyl string as the primary sourcesink 'ps' high frequency with small wavelength part of the modular dual supermembrane  $E_{ps} E_{ss}$  and with the secondary sinksources 'ss' being the low frequency with large wavelength part of the Witten supermembrane.

Then the Minimum Planck Oscillator  $E_{planck}^0 = \frac{1}{2} h f_{planck} = \frac{1}{2} m_{planck} \cdot c^2$  for  $T_{max} = T_{ps}$  and  $T_{min} = T_{ss}$  in string modular T-duality for  $\frac{1}{2} m_{planck} \cdot T_{planck} = (1/8\pi)(4\pi) \cdot m_{planck} \cdot T_{planck} = \text{Hawking Modulus}$

$HM = hc^3/4\pi G_0 k_B = M_{BHmin} \cdot T_{BHmax} = \{c^2/4\pi^2\} \cdot \{M_{BHmax} \cdot T_{BHmin}\}$ .  $B(n)$  is assigned  $B(n_{present}) = \{[ek_B](SI)/[ek_B]^*(*)\}$ , with  $\{[ek_B](SI) = \text{constant} = (1.60217662 \times 10^{-19} \text{ C})(1.380649 \times 10^{-23} \text{ J/K}) = 2.21204355 \times 10^{-42} \text{ CJ/K}\}$  and using the old (SI) value with the Alpha-Variation for ( $e'$ ).

Using ( $e^{\pm} = 1.6021119 \times 10^{-19} \text{ C}$ ) without the Alpha-Variation gives  $\{[ek_B](SI)\} = 2.21195419 \times 10^{-42} \text{ CJ/K}$ .

The (\*)-constant is a relatively fixed constant as: ( $e^{\pm} k_B^* = 2.267869086 \times 10^{-42} \text{ (CJ/K)^*}$ ) and subsequently  $B(n_{present})$  calculates a particular value for  $n$  at the asymptote  $B(n \Rightarrow \pm\infty) = 0$  for  $e = 1.606456344 \times 10^{-19} \text{ C}^*$ .

$\{[e^{\pm} k_B](SI)/[e^{\pm} k_B]^*\} = (2.21204355/2.267869086) = 0.975384145 = [2e/hA] \cdot \exp(-[\text{Alpha}]x[n_{present}^2 + n_{present}])$ , which yields a unique ( $n_{present}$ ) as a complex solution to the quadratic equation by  $\ln(0.975384145/0.992729803) = \{-\text{Alpha}\} \{n_{present}^2 + n_{present}\}$  for  $2.415747501 = n_{present}^2 + n_{present}$  for:  $n_{present}^2 + n_{present} - 2.415747501 = 0$  and solving as:  $\{n_{present} = \text{FRB}(-\frac{1}{2}) \pm 1.6327117\}$ .

$\{[e^{\pm} k_B](SI)/[e^{\pm} k_B]^*\} = (2.21195419/2.267869086) = 0.975344742 = [2e/hA] \cdot \exp(-[\text{Alpha}]x[n_{present}^2 + n_{present}])$ , which yields a unique ( $n_{present}$ ) as a complex solution to the quadratic equation by  $\ln(0.975344742/0.992729803) = \{-\text{Alpha}\} \{n_{present}^2 + n_{present}\}$  for  $2.421284031 = n_{present}^2 + n_{present}$  for:  $n_{present}^2 + n_{present} - 2.421284031 = 0$  and solving as:  $\{n_{present} = \text{FRB}(-\frac{1}{2}) \pm 1.634406324\}$ .

For the unfrozen M-space with Alpha-Variation:

{10D-root:  $n_{present} = 1.1327127$  (real) & 12D-root:  $n_{present} = -2.1327117$  (imaginary)}.

For the unfrozen M-space without Alpha-Variation: {10D-root:  $n_{present} = 1.1344063$  (real) & 12D-root:  $n_{present} = -2.1344063$  (imaginary)}.

The difference in the present  $n_p$  cycle-time coordinates so becomes:

$1.634406324 - 1.6327117 = 0.001694624$  as  $0.001694624/H_0 = 9.02486387 \times 10^{14} \text{ s}^*$  or 28.59865512 Million civil years. This 'unfreezing' of M-space then allows the singularity algorithm of the cosmogenesis to manifest in what might be called the sex chromosomes of the universal DNA-encoding in terms of frequency or a number count. A new physical quantity in 'awareness' is defined as the time differential of frequency and allows the concept of 'consciousness' to be born from the defining qualities of magneto charges.

## The Gravitational constant in the evolvment of the primordial nucleon mass $m_c = m_{\text{planck}} \cdot \{\alpha\}^9$

The Standard Gravitational Parameter  $\mu = GM = \text{constant} = G_o M(X^n Y^n) = G_o X^n \cdot M Y^n$  and for  $(XY)^n=1$  can be finestructured in a decreasing gravitational constant  $G(n)=G_o X^n$  with a corresponding increase in the mass parameter  $M$  as  $M(n)=M_o Y^n$  as say for the proto-nucleonic mass of the Instanton  $m_c(n_{ps})$  as  $m_c(n_{\text{present}}) = m_c \cdot Y^n_{\text{present}} = m_{\text{neutron}} < m_c Y^n_{\text{present}} = 1.711752 \cdot 10^{-27} \text{ kg}^*$  and  $958.99 \text{ MeV}^*$  upper limited

For a changing Gravitational constant  $G(n_{\text{present}}) \cdot m_{\text{neutron}}(n_{\text{present}})^2 = G_o m_c^2 \cdot Y^n_{\text{present}}$  and is modulated say in A micro-macro Black Hole perturbation  $M_o^2/2M_{\infty} \cdot M_{\text{MaxHawking}} = 1.000543 \sim 1$

The Black Holed mass equivalence for astrophysical bodies is well formulated in the application of the basic Schwarzschild metric derived from General Relativity.

Stephen Hawking developed the inverse proportionality between the mass of a Black Hole  $M$  and its Temperature  $T$  in the form of the Hawking Modulus:

$$HM = m_{\text{Planck}} \cdot E^{\circ}_{\text{Planck}}/k_b = \sqrt{\{hc/2\pi G_o\} \cdot \{1/2 m_{\text{Planck}} \cdot c^2/k_b\}} = hc^3/4\pi G_o k_b = \{M_{\text{Smin}} \cdot T_{\text{Smax}}\} \\ = [c^2/4\pi^2]_{\text{mod}} \cdot \{M_{\text{MaxHawking}} \cdot T_{\text{Smin}}\} = 9.131793821 \times 10^{23} \text{ kg}^* \text{K}^*$$

The Hawking Modulus so has mensuration units [Mass][Temperature] in [kg][K(elvin)] or [kgK]\* for the Stefan-Boltzmann entropy constant  $k_b=k_B$ .

And so  $M_{\text{min}} \cdot T_{\text{max}} = hc^3/4\pi G_o k_B = [c^2/4\pi^2]_{\text{mod}} \cdot M_{\text{max}} \cdot T_{\text{min}} = 1/2 m_{\text{Planck}} \cdot T_{\text{Planck}} = M_{\text{MaxHawking}} \cdot [c^2/4\pi^2]_{\text{mod}} \cdot T_{\text{SS}}$  and the Hawking Mass is determined as  $M_{\text{MaxHawking}} = \lambda_{\text{max}} \pi c^2/G_o = 2.54469 \cdot 10^{49} \text{ kg}^*$ .

HyperMass  $M_{\text{Hyper}}(n_{ps}) = hc^3 \cdot e^*/4\pi G_o = 6445.775 \text{ kg}$  at the Instanton boundary  $n=n_{ps}$  so increases to  $M_{\text{Hyper}}(n_{\text{present}}) Y^n_{\text{present}} = hc^3 \cdot e^*/4\pi G_o X^n_{\text{present}} \sim 11,117.26 \text{ kg}$  as the projected Instanton boundary mass for the wormhole radius  $r_{\text{wormhole}} = r_{ps}$  modulating the Inflaton curvature with the Instanton curvature and utilizing  $n_{\text{present}}=1.132712 \dots$  for a decreased perturbed  $G(n_{\text{present}}) = 6.442 \times 10^{-11} \text{ G-string units}$  for the Standard Gravitational Parameter  $G(n) m_i Y^k(n) \cdot m_j Y^{n-k} = G_o m_c^2 = \text{constant}$  for  $G(n)=G_o X^n$ .

Using the  $\lambda_{\text{min}} \lambda_{\text{max}}=1$  wavelength modulation in the T-duality of  $\lambda_{\text{min}}=2\pi R_{\text{min}}=1/\lambda_{\text{max}}=2\pi/R_{\text{max}}$ , this modulation closely approximates the geometric mean of the seedling mass in  $\{1/4\pi\} M_o^2/2M_{\infty} \cdot M_{\text{Max}}=M_o^2/8\pi \cdot M_{\infty} \cdot M_{\text{Hawking}} = 3.2895 \cdot 10^{102}/3.2931 \cdot 10^{102} \sim 0.998910744 \dots$

This also circumscribes the actual to critical density ratio in the omega of the general relativistic treatment of the cosmologies.

The applied  $G$  value in  $G_m(n)=G_o \cdot X^n$  as now coupled to the derived Black Hole Mass modulation coupled to the quantum micro masses.

$G_o m_c^2 = \{G_o X^{n+k}\} \cdot \{m_c Y^n\} \cdot \{m_c Y^k\} = G_m(n) \cdot m_{n\text{max}} \cdot m_{n\text{min}}$  and where  $G_m$  is the actual  $G$  value as measured and which has proved difficult to do so in the laboratories.

$G_m(n)=G_o \cdot X^{n+k}=G_o m_c^2/m_{n\text{max}} \cdot m_{n\text{min}}=G_o m_c^2/(\{m_c Y^n\} \{m_{n\text{min}}\})$  and where we have  $m_{n\text{min}}=m_c Y^k$  for the unknown value of  $k$  with  $m_{n\text{max}}=m_c Y^n$ .

So  $G_m(n) = G_o \cdot X^{n+k} = G_o X^n [m_c/m_{nmin}] = G_o \{m_c^2/m_c Y^n\} \cdot \{M_o^2/8\pi \cdot M_\infty \cdot M_{Hawking} \cdot m_{av}\}$  for  
 $X^k = \{m_c/m_{av}\} \cdot \{M_o^2/8\pi \cdot M_\infty \cdot M_{Hawking}\} = 1.00109044 \dots \{m_c/m_{av}\}$

and where now  $\{m_{nmin}\} = \{8\pi \cdot M_\infty \cdot M_{Hawking} \cdot m_{av}/M_o^2\} = 1.00109044 \dots m_{av}$ .

$m_{av} = \{M_o^2/8\pi \cdot M_\infty \cdot M_{Hawking}\} \{m_{nmin}\} = \{M_o^2/8\pi \cdot M_\infty \cdot M_{Hawking}\} \{m_c Y^k\} = 0.9989107 \dots \{m_c Y^k\}$  and represents a reduced minimum mass  $m_{nmin} = m_c Y^k$ .

But the product of maximum and 'new' minimum now allows an actual finetuning to a measured nucleon mass  $m_N$  by:

$$m_N^2 = m_{av} Y^n \cdot m_c Y^n = m_{av} \cdot m_{nmax} \cdot Y^n.$$

So, substituting for  $m_{av}$  in our  $G_m$  expression, will now give the formulation:

$$G_m(n) = G_o \cdot X^{n+k} = G_o X^n [m_c/m_{nmin}] = G_o \{m_c^2/m_c Y^n\} \cdot \{M_o^2/8\pi \cdot M_\infty \cdot M_{Hawking} \cdot m_{av}\}$$

$$G_m(n) = G_o \cdot X^{n+k} = G_o X^n [m_c/m_{nmin}] = G_o \{m_c^2/m_c Y^n\} \cdot \{M_o^2/8\pi \cdot M_\infty \cdot M_{Hawking}\} \{m_c Y^{2n}/m_N^2\}$$

$$G_m(n) = G_o \cdot \{m_c^2/m_N^2\} \{M_o^2/8\pi \cdot M_\infty \cdot M_{Hawking}\} Y^n$$

The average nucleon mass  $m_N$  is upper bounded in the neutron mass and lower bounded in the proton mass, their difference being an effect of their nucleonic quark content, differing in the up-down transition and energy level and because of electro charges increasing the intra-quarkian Magneto charge coupling between the two mesonic rings of the neutron and a single mesonic ring in the proton's down- or KIR-quark.

For a Neutron Restmass of:  $m_{neutron} = 1.6812656 \times 10^{-27} \text{ kg}^* (941.9111 \text{ MeV}^*)$

or  $(1.6749792 \times 10^{-27} \text{ kg}$  and  $939.554 \text{ MeV})$

the substitution (and using calibrations  $m = 1.001671358 \text{ m}^*$ ;  $s = 1.000978395 \text{ s}^*$ ;  $kg = 1.003753127 \text{ kg}^*$  and  $C = 1.002711702 \text{ C}^*$  gives:

$$G(n_p) = G_o \{m_c/m_{neutron}\}^2 \cdot (0.9989107 \dots) Y_p^n = 6.670693 \times 10^{-11} (\text{m}^3/\text{kgs}^2)^*$$

or  $6.675312 \times 10^{-11} (\text{m}^3/\text{kgs}^2)$ .

For a Proton Restmass of:  $m_{proton} = 1.6788956 \times 10^{-27} \text{ kg}^* (940.5833 \text{ MeV}^*)$

or  $(1.672618 \times 10^{-27} \text{ kg}$  and  $938.270 \text{ MeV})$ .

$$G(n_p) = G_o \{m_c/m_N\}^2 \cdot (0.9989107 \dots) Y_p^n = 6.6895399 \times 10^{-11} (\text{m}^3/\text{kgs}^2)^*$$

or  $6.694171 \times 10^{-11} (\text{m}^3/\text{kgs}^2)$ .

$$G_m(n) = G_o \cdot X^{n+k} = 6.670693 \times 10^{-11} (\text{m}^3/\text{kgs}^2)^* \text{ then gives } k_p = \ln\{G_m(n_p)/G_o\} / \ln\{X\} - n_p$$

$$= 1.0602852 - 1.132712 = -0.0724258$$

The upper value of the neutron bound so represents an upper limit for the Gravitational Constant as the original quark-lepton bifurcation of the X-Boson precursor given in the KKK kernel. Only the KKK kernel is subject to the mass evolution of the cosmos; the leptonic masses being intrinsically incorporated in the Kernel means.

The  $m_c \cdot Y^n$  so serves as an appropriate upper bounded approximation for  $G(n)$ , subject to leptonic ring IR-OR perturbations.



The best approximation for 'Big G' hence depends on an accurate determination for the neutron's inertial mass, only fixed as the base nucleon minimum mass at the birth of the universe. A fluctuating Neutron mass would also result in deviations in 'G' independent upon the sensitivity of the measuring equipment. The inducted mass difference in the protonic-and neutronic rest masses, derives from the

Higgs-Restmass-Scale and can be stated in a first approximation as the ground state.

Basic nucleon rest mass is  $m_c = \sqrt{\Omega} \cdot m_p = 9.9247245 \times 10^{-28} \text{ kg}^*$  or  $958.99 \text{ MeV}^*$ .

(Here Omega is a gauge string factor coupling in the fundamental force interactions as:

Cube root(Alpha):Alpha:Cube root(Omega):Omega and for Omega=G-alpha.)

KKK-Kernel mass=Up/Down-HiggsLevel= $3 \times 319.66 \text{ MeV}^* = 958.99 \text{ MeV}^*$ , using the Kernel-Ring and Family-Coupling Constants.

Subtracting the Ring-VPE (3L) gives the basic nucleonic K-State as  $939.776 \text{ MeV}^*$ . This excludes the electronic perturbation of the IR-OR oscillation.

For the Proton, one adds one (K-IR-Transition energy) and subtracts the electron-mass for the d-quark level and for the Neutron one doubles this to reflect the up-down-quark differential.

An electron perturbation subtracts one  $2 - 2/3 = 4/3$  electron energy as the difference between 2 leptonic rings from the proton's 2 up-quarks and  $2 - 1/3 = 5/3$  electron energy from the neutron' singular up-quark to relate the trisected nucleonic quark geometric template.

Proton  $m_p = u.d.u = K.KIR.K = (939.776 + 1.5013 - 0.5205 - 0.1735) \text{ MeV}^* = 940.5833 \text{ MeV}^* (938.270 \text{ MeV})$ .

Neutron  $m_n = d.u.d = KIR.K.KIR = (939.776 + 3.0026 - 1.0410 + 0.1735) \text{ MeV}^* = 941.9111 \text{ MeV}^* (939.594 \text{ MeV})$ .

This is the ground state from the Higgs-Restmass-Induction-Mechanism and reflects the quarkian geometry as being responsible for the inertial mass differential between the two elementary nucleons. All ground state elementary particle masses are computed from the Higgs-Scale and then become subject to various finestructures. Overall, the MEASURED gravitational constant 'G' can be said to be decreasing over time.

The ratio given as k is  $G_m Y^n / G_o \sim 0.600362...$  and so the present G-constant is about 60% of the one at the Planck Scale.

G decreases nonlinearly, but at a present rate of  $0.600362 / 19.12 \times 10^9$  per year, which calculates as  $3.1400 \dots \times 10^{-11}$  G-units per year.

Generally using the exponential series expansion, one can indicate the change in G.

For  $X^{n+k} = z = \exp[(n+k)\ln X]$  by  $(n+k)\ln X = \ln z$  for the value  $u = (n+k)\ln X = -0.481212(n+k)$ ; z transforms in exponential expansion  $e^u = 1 + u + u^2/2! + u^3/3! + u^4/4! + \dots$

For a function  $f(n) = z = G_m(n) / G_o = X^{n+k} - f(n) = 1 - (0.481212)(n+k) + (0.2316)(n+k)^2 / 2 - (0.1114)(n+k)^3 / 6 + (0.0536)(n+k)^4 / 24 - \dots + \dots$

At time instantaneity of the Quantum Big Bang,  $n = n_{ps} = \lambda_{ps} / R_{max} = 6.2591 \times 10^{-49} \sim 0$

Then  $G_{BigBang} = G_o X^{n_{ps}} = G_o$  (to 50 decimal places distinguishing the time instanton from the Null time as the Planck-Time transform).

$G_o$  represents the quantum gravitational constant applicable for any Black Hole cosmology and can be used to correlate the MOND gravitation with the Newton-Einstein gravitation in inferring a greater gravitational constant in the cosmic past in conjunction with an inherent Milgröm deceleration as a time derivative of the universal scale factor  $a=\{n/[n+1]\}$ .

For our previously calculated  $k=\ln(G_m \gamma^n / G_o) / \ln X$  and which calculates as  $k= -0.0724258..$   
 $f(n)=1-(0.481212.)(n+k)+(0.2316.)(n+k)^2/2-(0.1114.)(n+k)^3/6+(0.0536.)(n+k)^4/24-(0.0258.)(n+k)^5/120+...-...$   
 for  $f(1.132712)=1-0.51022+0.13016-0.02214+0.00283-0.000288...+... \sim 0.6006340$  to fifth order approximation to  $0.60036246...$

Hence, the gravitational constant assumes a value of about 60.0% of its Big Bang initialization and calculates as  $6.675 \times 10^{-11}$  G-units for a present cycle time  $n_{\text{present}}=H_o t_{\text{present}}=1.132712...$

The introduction of the mass seed coupling between the macro quantum  $M_o$  and the micro quantum  $m_c=m_p \alpha^9$  (from the gravitational finestructure unification) perturbs the 'purely electromagnetic' cosmology in the perturbation factor  $k$  and increases the purely electromagnetic  $G_{\text{memr}}$  in the black hole physics described.

So gravity appears stronger when one 'looks back in time' or analyses cosmological objects at large distances. The expansion parameter ( $a$ ) in the Friedmann-Einstein standard cosmology can be rewritten as a curvature ratio  $R(n)/R_{\text{max}}=\{n/(n+1)\}$  and describes the asymptotic universe in say 10 dimensions evolving under the inertial parameters of the c-invariance.

This 'lower dimensional universe' is open and expands under hyperbolic curvature under the deceleration parameter  $q_o=\frac{1}{2}\Omega_o=M_o/2M_\infty=2G_o H_o M_o / c^3 \sim 0.014015...$  This open universe is bounded in the 'standing wave' of the Hubble Oscillation of the 11D and 'higher dimensional universe'.

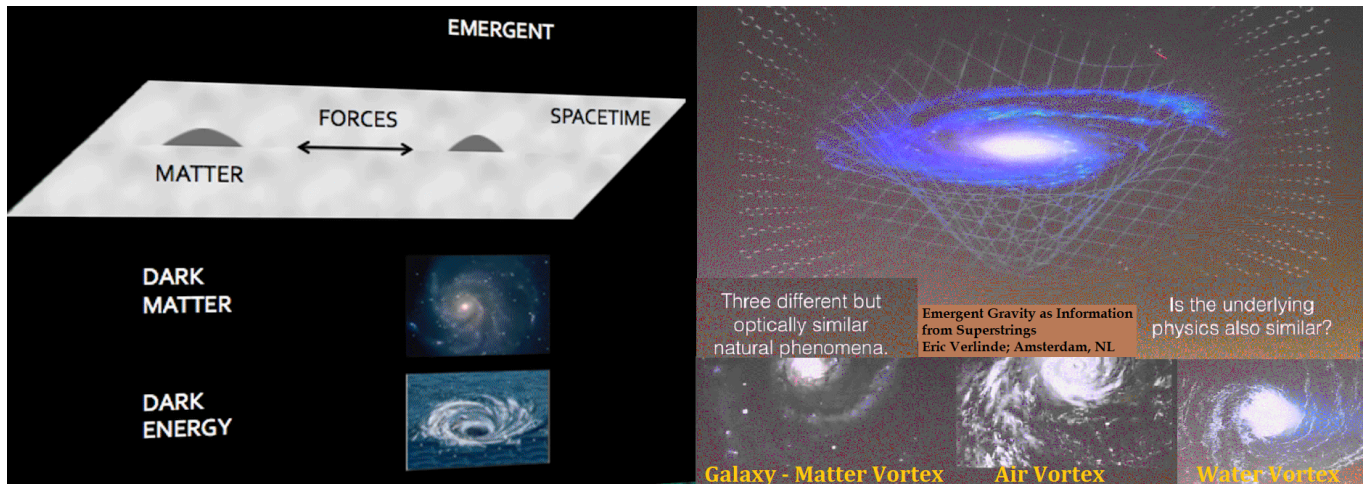

### XIII: The Inflaton and the Grand Unification Symmetry in a Transformation of Supermembranes

SEWG-----SEWg-----SEW.G-----SeW.G-----S.EW.G-----S.E.W.G  
 Planck Unification I-----IIB-----HO32-----IIA-----HE64--Bosonic Unification

{Capitalization of letters infers emphasis and decapitalization of letters implies suppression of respective fundamental interactions}.

The transformation of the 5 superstring classes proceeds in utilizing the self-duality of superstring IIB as the first energy transformation of the Inflaton in the Planck string class I trans mutating into the monopole string class IIB and residing in the 2-toroidal bulk space of Vafa as a Riemann 3-dimensional surface describing the VPE-ZPE of the micro quantum of the QBBS.

The  $E_{ps}$ -Weyl wormhole of topological closure so is holographically and conformally mapped onto the bulk space in 12 dimensions as a braned volumar evolving by mirror duality of the 11dimensional closed AdS membrane space of Witten's M-space as Vafa's F-space and mirroring the hyperbolic topology of 10-dimensional C-space as an open dS cosmology in an overall measured and observed Euclidean flatness of zero curvature.

String Boson	Decoupling Time s*	Wavelength $(\lambda=2\pi l)$ m*	Energy $(hc/\lambda)$ J* & eV*	Modular Wavelength h m*	Temp K*	Significance
0. Genesis-Boson Algorithmic	TIME=1/FREQUENCY $= \lambda_{ps}/R_H = \lambda_{ps}H_0/c$ $= n_{ps} = H_0 t_{ps}$ $6.2591 \times 10^{-49}$	LIGHTPATH c.TIME $1.877 \times 10^{-40}$	ENERGY= $hR_{max}/\lambda_{ps}$ $=k.TEMPERATURE$ $E$ $=h.FREQUENCY$ $=h/TIME=MASS.$ $c^2$ $1.065 PJ^*$ or $6.629 \times 10^{33} eV^*$	$5.326 \times 10^{39}$	TEMPERATURE $= hR_{max}/k\lambda_{ps}$ $7.54481 \times 10^{37}$	Algorithmic Definition
1. Planck Length Bounce $\sqrt{\alpha} L_{planck} c^2 = e \leftrightarrow e^* = 2R_e c^2 = 1/E_{ps}$	$t_{OPL} = 2\pi r_{OPL}/c$ $3.739 \times 10^{-44}$	$1.122 \times 10^{-35}$	$17.830 GJ^*$ or $1.110 \times 10^{29} eV^*$	$8.913 \times 10^{34}$	$1.263 \times 10^{33}$	Quantum Fluctuation of Creation
2. Planck-Boson I/SEWG $\Rightarrow$ sEwG	$t_P = 2\pi r_P/c$ $4.377 \times 10^{-43}$	$L_P = 2\pi r_P$ $1.313 \times 10^{-34}$	$1.523 GJ^*$ or $9.482 \times 10^{27} eV^*$	$7.617 \times 10^{33}$	$1.079 \times 10^{32}$	Outside Hubble Horizon Limit in Protoverse

3. Monopole-Boson IIB/sEWG⇒SEWg GI-GUT decoupling max = 30 [ec] min = 1 [ec]	$t_M=2\pi r_M/c$ $5.124 \times 10^{-42}$ [max] to [min] $t_M=2\pi r_M/c$ $1.537 \times 10^{-40}$	$1.537 \times 10^{-33}$ [max] to [min] $4.611 \times 10^{-32}$	13.011 MJ* or $8.100 \times 10^{26}$ eV* [max] to [min] 4.337 MJ* or $2.700 \times 10^{25}$ eV*	$6.506 \times 10^{32}$ [max] to [min] $2.169 \times 10^{31}$	$9.216 \times 10^{30}$ [max] to [min] $3.072 \times 10^{29}$	Outside Hubble Horizon Limit in Protoverse
4. XLBoson HO32/SEW.G	$t_{XL}=2\pi r_{XL}/c$ $2.202 \times 10^{-39}$	$6.605 \times 10^{-31}$	302.817 kJ* or $1.885 \times 10^{24}$ eV*	$1.514 \times 10^{30}$	$2.145 \times 10^{28}$	Outside Hubble Horizon Limit in Protoverse
5. Ecosmic-Boson IIA/SeW.G SNI decoupling	$t_{EC}=2\pi r_{EC}/c$ $6.618 \times 10^{-34}$	$1.986 \times 10^{-25}$	1.0073 J* or $6.270 \times 10^{18}$ eV*	$5.035 \times 10^{24}$	$7.135 \times 10^{22}$	Galactic Supercluster Sarkar Scale $M_o=R_{Sarkar}$ $c^2/2G_o$
6. False Higgs Vacuum (min to max)	$t_{Hmin}=G_o M_o/c^3 n_{ps}$ $4.672 \times 10^{-33}$ [min] to [max] $t_{Hmax}=V\alpha t_{ps}$ $2.847 \times 10^{-32}$	$1.402 \times 10^{-24}$ [min] to [max] $8.541 \times 10^{-24}$	0.143 J* or $8.883 \times 10^{17}$ eV* [min] to [max] 0.023 J* or $1.458 \times 10^{17}$ eV*	$1.171 \times 10^{23}$ [min] to [max] $7.133 \times 10^{23}$	{ $7.206 \times 10^{37}$ [min] to [max] $1.857 \times 10^{37}$ Algorithmic from Genesis Boson}	Galactic Supercluster Scale
7. Weyl-Boson HE64/S.EW.G Big Bang Instanton EMI decoupling	$t_{ps}=2\pi r_{ps}/c$ $3.333 \times 10^{-31}$	$1.000 \times 10^{-22}$	0.002 J* or $1.245 \times 10^{16}$ eV*	$1.000 \times 10^{22}$	{Temperature Gradient $T_{ps}/T(n_{ps})$ Genesis Boson $T(n_{ps}) =$ $2.935 \times 10^{36}$ }	Galactic Halo (Group) Scale
8. T(n)= $T_{ps}$ Bosonic Condensate Unification	$t_{BU}=n_{BU}/H_o$ $1.897 \times 10^{-9}$	$ct_{BU}/(1+H_o t_{BU})$ 0.5691 Protoverse Inflaton min to Instanton to Inflaton max $10^{-22}$	Bosonic Plasma $h/t_{BU}$ $3.514 \times 10^{-25}$ J* or $2.188 \times 10^{-6}$ eV* 0.002 J* or 12.45 PeV*	1.757 Protoverse $10^{22}$	$T_{BU} = T_{ps}$ $= 1.417 \times 10^{20}$ $18.2[n+1]^2/n^3$ $n=H_o t_{BU}$	Unitary Modular Geometric Mean Scale

9. Electroweak WNI decoupling	$t_{EW} = n_{EW}/H_0$ 0.00714~1/140	8.543x10 <sup>-18</sup>	2.341x10 <sup>-8</sup> J* or 145.70 GeV*	1.171x10 <sup>17</sup>	1.658x10 <sup>15</sup>	Higgs Boson RMP DM scale
10. Higgs Chi-Boson/ Super Diquark Sbar=ss Quark-Lepton scale Vacuum Expectation	$t_{QL} = n_{QL}/H_0$ 0.00274~1/365	2.227x10 <sup>-17</sup> Quantum Scale	4.799x10 <sup>-8</sup> J* or 298.785 GeV*	4.490x10 <sup>16</sup>	3.400x10 <sup>15</sup>	Outer Leptonic Inner Mesonic Kernel Quantum scale

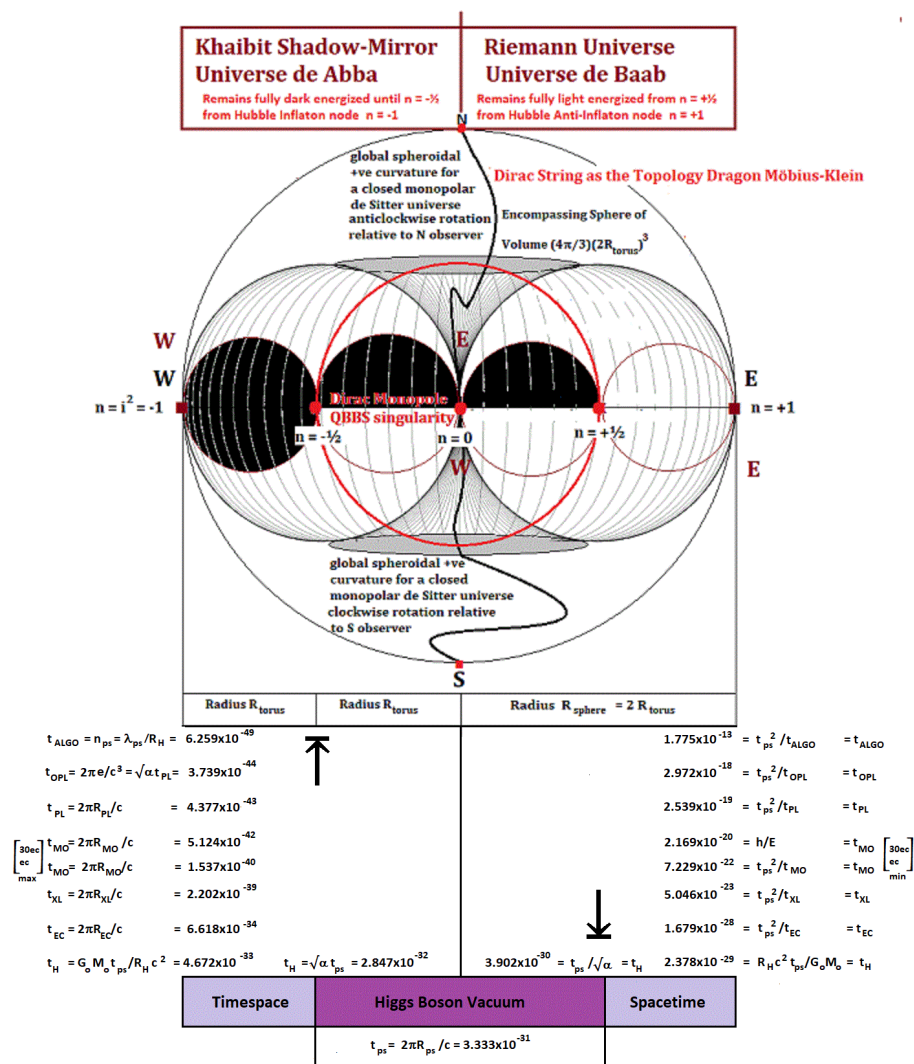

## Quantum Gravitation Unification in a Coupling of the Supermembranes in Self dual Monopole Class IIB

SEWG --- SEWg as string transformation from Planck brane to (Grand Unification/GUT) monopole brane. The X-Boson is modular dual to the L-Boson in the string class transformation from the Planck brane to the monopole brane to the X/L-brane to the Cosmic String brane to the Weyl brane.

For the X-Boson, the coupling can be written as:  $\# \cdot (m_{ps}/m_{Planck})f(G)$  and for the L-Boson it is written as:  $\#^{54} \cdot (m_{Planck}/m_{ps})f(S)$  to indicate the inherent modular duality.

As  $\alpha = \#^3$  specifies the emmr-matter-emr interaction probability;  $EMI/SNI = \#^3/\# = \#^2$  breaks the unified symmetry via the WNI and defines  $\#f(G)$  as a unitary mass.

A 'mixing angle'  $\theta_{ps}$  is defined via constant  $X \Rightarrow \{\aleph\}^3 \Rightarrow \alpha$  as  $X = \varpi(n) \cdot \sin \theta_{ps}$  for a unitary force action  $\varpi(n)$  acting on the inflaton acceleration  $cf_{ps}$  coupled to the inflaton source hyper-acceleration of the de Broglie matter wave for phase speed  $R_H f_{ps}$  in  $R_H f_{ps}^2 = 1.43790791 \times 10^{87} (m/s^2)^*$  in the displacement light path for the nodal Hubble constant  $H_0 = dn/dt = c/R_H$  defining the frequency ratio  $n_{ps} = \lambda_{ps}/R_H = 2\pi r_{ps}/R_H = f_{ps}/H_0$  as the linearization of the wormhole from its closed Planck brane form as string class I into its transformation as open string class HE(8x8) then manifesting as the Compton-de Broglie wavelengths in the emmr-matter-emmr interactions. The inflaton angle  $\theta_{ps}$  so is maximized at  $90^\circ$  at  $X = \varpi(n) \cdot \sin \theta_{ps}$  for  $\theta_{ps} = 38.17270761^\circ$  for a unitary force  $\varpi(n)=1$  and for the X/L bosonic coupling for a GUT scale characterizing SEW.G for the decoupling of the gravitational interaction from the unified energy field described by the Standard Model.

Now the Planck string for a Planck time of  $t_p = 2\pi r_p/c = 4.377 \times 10^{-43}$  is connected to the X/L string via the monopole string at the unified SEWG level in the self-duality of the GUT-monopole at  $[ec \cdot c^2]_{uimd} = 2.7 \times 10^{16} \text{ GeV}^*$  and at a brane inflaton time of  $t_M = 2\pi r_M/c = 1.537 \times 10^{-40} \text{ s}^*$  and for which SEWG transformed into sEWG to indicate the unified nature between the long-range EMI and GI in a coupling of the electromagnetic and gravitational fine structures here termed alpha and g-alpha respectively.

The X/L boson time is  $t_{XL} = 2\pi r_{XL}/c = 2.202 \times 10^{-39} \text{ s}^*$  and string class HO(32) decouples gravity in replacing  $f(G)/m_{Planck}$  by the monopole mass  $\#^2/[ec]_{uimd}$  modular dual to  $f(S)m_{Planck}$  to account for the SNI/EMI breaking of the native supersymmetry SEWG and to transform the Planck brane energy scale into the X/L brane energy scale.

**$m_{XB} = \alpha \cdot m_{ps}/[ec]_{uimd} = \#^3 \cdot m_{ps}/[ec]_{uimd} = 3.364554269 \times 10^{-12} \text{ kg}^* = 1.884955575 \times 10^{15} \text{ GeV}^*$  unifying SEW in the monopolar electron boson energy  $m_{ec}|_{max} = \alpha m_{ps}$   $m_{LB} = \alpha^{18} \cdot [ec]_{uimd}/\#^2 \cdot m_{ps} = \#^{52} \cdot [ec]_{uimd}/\#^2 \cdot m_{ps} = 1.982105788 \times 10^{-28} \text{ kg}^* = 111.0453587 \text{ MeV}^*$  unifying EWG at the bosonic muon energy**

The X-Boson mass and the L-Boson mass then transform into the string class IIA, as the coupling from the self-dual monopole class, here termed the ECosmic Boson to indicate its native characterization as primordial cosmic string ancestor for a spectrum of cosmic rays, tabulated following this discussion.

The ECosmic Boson manifests at an inflaton time of  $t_{EC} = 2\pi r_{EC}/c = 6.717 \times 10^{-34} \text{ s}^*$  at an energy of  $0.9927 \text{ J}^*$  or  $6.180 \times 10^9 \text{ eV}^*$  and as a consequence of the universal wavefunction  $B(n) = \{2e/hA\} \cdot \exp\{-\text{Alpha} \cdot T(n)\}$  and where  $T(n) = n(n+1)$  defines X and Y in the Euler identity for  $T(n)=1$ .

The electromagnetic interaction, which was emphasized in the decoupling of the gravitational interaction in the sEWG to form the X/L-Boson in SEW.G now becomes suppressed in SeW.G in the B(n) for  $n=n_{ps}=6.259093473 \times 10^{-49} \Rightarrow 0$  and  $T(0)=0$  for  $B(n_{ps})=2e/hA=0.992729794\dots$  in units of inverse energy that is as units of the magneto charge under modular string duality.

The constant  $A=4.854663436 \times 10^{14}$  Ampere\* can be defined as a cosmic string magneto current, derived from algorithmic encodings underpinning the numerical values for the fundamental constants of nature.

The ECosmic boson then triggers a 'false vacuum' in a brane time interval from  $t_{dBmin}=G_o M_o/c^3 n_{ps} = 4.672 \times 10^{-33}$  [min] to [max]  $t_{dBmax}=\sqrt{\alpha} t_{ps} = 2.847\dots \times 10^{-32}$  defined in a non-kinematic temperature gradient of the cosmogenesis and related to the hyper acceleration gradient between the de Broglie inflaton wave phase speed  $a_{dB} = R_H f_{ps}^2$  and the boundary cosmological (dark energy) constant  $\Lambda_{Einstein}(n_{ps}) = G_o M_o/\lambda_{ps}^2$  with  $2 \cdot \Lambda_{Einstein}(n_{ps})/a_{dB} = M_o/M_H=0.02803\dots$  descriptive for the baryonic matter content at the instanton as a proportional coupling between the 'mother black hole' defined in the Schwarzschild metric with an event horizon the size of the Hubble radius  $R_H = 2G_o M_H/c^2$ .

It can be said that the universal wave function B(n) remains 'frozen' within this encompassing inflaton event horizon about the FRB (Functional Riemann Bound) at the  $x=-\frac{1}{2}$  coordinate and between a cosmic uncertainty interval  $\{X: -1,0\}$  defining the Witten-M-space in this presentation; until it is observed and/or defined in accordance with the premises of quantum mechanics applied to the universe in total.

The 'unfreezing' of B(n) requires the linearization of the quantum geometric circularity of the Compton wavelength into its particularized quantum radius.

## Quark-Lepton Unification in XL-Boson Class HO(32) SEWg --- SEW.G

Following the creation of the 'false Higgs vacuum' as a potential spacetime quantum and as a prototypical holofractal of the brane volumar; the Planck string and now as an ECosmic string of increased spacial extent and of lower energy transforms into the Weyl- $E_{ps}$  Boson of the quantum big bang event as the instanton.

This results in an integration or summation of  $E_{ps}$ -quanta evolving at the speed of light from the original Weylian wormhole as the 'creation singularity'.

This 'filling' of the inflaton M-space with lower dimensional instanton C-space represents however an attempt by the wormhole summation, which is expanding originally at the speed of light to become retarded by a force opposing the linear expansion and so decurving of the original wormhole definition.

This effect of anti-curvature or the attempt to recircularized the linearization of the lower dimensional expanded membrane space by its higher dimensional contracting (or collapsing) membrane space is known as gravity in the macrocosmic cosmology of General Relativity but represents the integrated effect of quantum gravity as a summation of spacetime quanta as wormhole volumars inhabiting expanding space as boundary and initial condition for contracting spacetime.

The expanding qbb or the integration and multiplication of wormhole quanta now enables the X/L bosons to transform into a quark-lepton hierarchy at instanton time  $t_{ps}=f_{ss}=1/f_{ps}=3.333 \times 10^{-31}$  s\*.

The Higgs vacuum is now rendered as physical in spacetime occupancy, and the relative sizes of elementary particles is defined in the diameter of the electron and its parameters of energy and momentum. In particular  $e^* = 2R_e c^2 = 1/E_{ps}$  restrict the extent of the Compton constant in the mass and size of the electron and quantizing the quantization of monopolar energy in the volumar equivalent of the inversed source energy quantum of the Weyl- $E_{ps}$  Boson conformally transformed from the Planck scale onto the Weyl wormhole scale in the superstring transformations.

Magnetopolar charge  $e^*$  as inversed energy quantum in its higher dimensional form assumes the characteristic of a region of space acted upon by the time rate change of frequency or  $df/dt$ . As said, this allows a definition of physical consciousness as the action of a quasi-angular acceleration as  $df/dt$  onto the dynamics of anything occupying any space, if this space represents a summation of  $E_{ps}$ - gauge photon quanta. The concept of physical consciousness so finds its resolution in the quantum geometry of super brane volumars.

The Higgs field of physical consciousness so applies action on spatially occupied dynamics, such as elementary particles or collections and conglomerations of particles, irrespective of particles exhibiting inertial mass or gravitational mass because of the photonic energy equivalence to mass in  $E=hf=mc^2$ .

The X-Boson of energy  $1.885 \times 10^{15}$  GeV\* so transforms into a K-Boson of energy given by transformed Planck boson into the K-Boson with  $m_c = m_{Planck} \cdot \alpha^9 = k_e e \alpha^{8.5} = (e/G_o) \alpha^{8.5} = 9.924724514 \times 10^{-28}$  kg or 556.0220853... MeV\* under Planck-Stoney unification for electric charge and mass.

The primordial K-Boson so becomes the ancestor for all nucleons and hyperons as a base kernel energy as a function of cycle time  $n$  in  $m(n) = m_c Y^n$ .

For an invariance of the Gravitational parameter  $GM = G_o X^n \cdot M Y^n = \text{constant}$ , a mass evolution in the constancy of  $XY = X+Y = e^{i\pi} = i^2 = -1 \forall n$  can be applied to 'evolve' the mass of the K-Boson as a function of cycle time  $n$  from its initial self-state  $n_{ps} = H_o / f_{ps} = \lambda_{ps} / R_H$  and to relate the history in time to a history of space in a timeless cosmogenesis.

The upper bound for the kernel mass so becomes  $m_c Y^{n_{present}} = 1.71175285 \times 10^{-27}$  kg\* or 958.9912423... MeV\* for  $n_{present}$  set at 1.132712...

The K-Boson then assumes the form of a trisected subatomic core in distributing the K-superstring energy in three quantum geometric parts or sectors depictable in three 120-degree regions of a gluon field for the 8 gluon permutations between the SU(3) self-states:

$E = mc^2$ : {BBB; BBW; WBB; BWB; WBW; BWW; WWB; WWW}:  $E = hf$ , for the hyperon SU(3) unitary quark or antiquark distribution and  $E = mc^2$ : {BB; BW; WB; WW}:  $E = hf$  for the mesonic quark-antiquark couplings for SU(2), with the (W)hite state implying complete emr-emmr dematerialization and the (B)lack state inferring complete materialization in the chromodynamics of the colour mixing and gluon charge exchanges.

The L-Boson then induces the outer leptonic OR ring structure as the ancestor of the muon fermion and the inner mesonic ring or IR becomes the oscillatory potential for the OR to reduce in size to approach the kernel K trisected in the gluon distribution.



The precursive X/L-Boson transforming into the quark-lepton hierarchy of fermions, so manifests a native supersymmetry or supergravity without any necessity for additional particles or string vibrations in unification physics.

It can then be said that the meeting or intersection of the OR with the Kernel K occurs at the IR in the form of neutrinos and anti-neutrinos emitted by the kernel as the partners for the OR manifesting as three leptonic generations in electron, muon and tauon to define the weak interaction bosons in the weakons and the Z-Boson.

The weakons so display the bosonic nature of the original X/L bosons but allow a partitioning of the boson integral spin momentum in a sharing between the fermionic kernel and the fermionic outer ring. The quantum geometry indicated then allows a decomposition of the weakons into leptonic generations and the Z-Boson to assume the weak interaction energy in the form of massless gluons becoming mass induced by the quantum geometric template of a scalar Higgs field as Majorana neutrinos.

This can be illustrated in the quantum chromodynamics of the trisection of both kernel and rings as the mixing of colour charges as indicated.

Subtracting the L-Boson mass from the K-Boson mass then sets energy intervals shown following in the diquark hierarchies found in the quantum geometry of Quantum Relativity. The energy interval for the KKK kernel then becomes (282.6487 MeV\* - 319.6637 MeV\*) and is defined as a Kernel-Ring-Cross-Coupling constant, where  $111.045/3 = 37.015$  gives the appropriate energy range for a particular quark energy level for a ground state GS:

$$\text{GS} = \text{GS}_{n-1} + 2g_{n-1} + \text{ULM}^{n-2} \cdot \{ \frac{1}{2}e^-; \frac{2}{3}e^- \}$$

$$= \text{Iterative Kernel GS} + \text{Ring Perturbation}$$

$$\text{Matrix } |\text{VPE}| = \begin{bmatrix} K_1 & K_2 \\ L_1 & L_2 \end{bmatrix} = \begin{bmatrix} a & b \\ c & d \end{bmatrix} \text{ for } \text{Det}|\text{VPE}| = ad - bc = 0 = K_1L_2 - K_2L_1 = (46.100)(1.501) - (14.113)(4.903) = g_{L1}(\mu) - g_{L2}(\text{md})$$

$$\text{Matrix } |\text{md};\mu| = \begin{bmatrix} L_1 & L_2 \\ L_1-L_2 & 1 \end{bmatrix} = \begin{bmatrix} L_1 + L_2 \\ L_1 - L_2 \end{bmatrix} \text{ for } \text{Det}|\text{md};\mu| = -2L_1L_2 \text{ with } |\text{md};\mu|^{-1} = \frac{-1}{2L_1L_2} \begin{bmatrix} -L_2 & -L_2 \\ -L_1 & L_1 \end{bmatrix} = \frac{-1}{2\text{md}\mu} \begin{bmatrix} -\mu & -\mu \\ -\text{md} & \text{md} \end{bmatrix}$$

Linear dependency given by  $\text{Det}|\text{VPE}| = 0$  and  $g_{L1}/g_{L2} = K_1/K_2 = L_1/L_2 = \text{ULM} = 3.2665...$   
 For  $k=\{1;2;3;...8;9;10\}=\{2;1;(u,d);s;(cU);b;M;D;t;S\}$ :  
 For 2 Groundstates GS with  $n \geq 2$ :

$$\text{Kernel-Ring Mixing Constant: } K_X/R_L = m_c Y^n / 3m_{LB} = 958.991 / (3 \times 111.045) = 2.8786858$$

$$\text{for } n_{\text{present}} = 1.1327127...$$

$$\text{Nucleonic Upper Limit: } m_c Y^n_{\text{present}} = 1.71175285 \times 10^{-27} \text{ kg}^* = 958.9912423 \text{ MeV}^*$$

$$\text{Unitary Coupling Force: } \omega(n_{\text{present}}) / \sqrt{Y^{n_{\text{present}}}} = \#f(G).cf_{ps}\{\alpha_E/\alpha\}$$

$$= 2\pi c G_0 m_{\text{planck}} m_{ps} m_e m_c \nu(Y^{n_{\text{present}}}) / e h^2 = 1.33606051$$

$$\alpha_E = 2\pi G_0 m_c m_e / hc \text{ for } m_c \nu(Y^n); \text{ as ring masses } m_{e,\mu,\tau} \text{ are constant in kernel masses}$$

$$\alpha_G = 2\pi G_0 m_c^2 / hc \text{ for kernel mass } m_c \text{ as } m_c Y^n$$

Graviton-GI mass:  $\#f(G)=\alpha \cdot m_{\text{planck}}/[ec]_{\text{uimd}}$  transforms  $m_{\text{ps}}$  from  $m_{\text{planck}}$  in  $m_{\text{XB}}$

Coupling angle:  $\theta_{\text{ps}}(n_{\text{present}}) = \text{Arcsin}(X/\varpi(n_{\text{present}})) = \text{Arcsin}(0.4625\dots) = 27.553674^\circ$

Upper Bound Multiplier = 1/Lower Bound Multiplier

ULM = 1/LBM =  $90^\circ/\theta_{\text{ps}}(n_{\text{present}}) = 3.26663521$

Using those definitions allows construction for the diquark hierarchies following.

Reducing the atomic scaling to its intrinsic superstring dimension shows the Higgs Bosonic Restmass Induction, corresponding to the Dilaton of M-Theory.

Renormalizing the wavefunction  $B(n)$  about the FRB =  $-\frac{1}{2}$  as maximum ordinate gives a probability  $y^2 dV$  for  $y(0) = v(\alpha/2\pi)$  for the renormalization.

$\alpha/2\pi$  being the probability of finding the FRB fluctuation for the interval  $[-X, X-1]$  in volume element  $dV$  as the uncertainty fluctuation.

This volume element defines the dimensional intersection from C-Space into F-Space via M-Space in the topological mapping of the complex Riemann  $C_\infty$ -Space about the Riemann pole of the FRB as the Calabi-Yau superstring space in 10 dimensions.

with  $T^2(n) = 1 = X(X+1) = -i^2 = -XY$  in the Feynman-Path-Integral as alternative quantum mechanical formulation for the equations of Schrödinger, Dirac and Klein-Gordon by:  $T(n)=n(n+1) = |-n| + \dots + |-3| + |-2| + |-1| + 0 + 1 + 2 + 3 + \dots + n$

$$B(n) = \frac{2e}{hA} \cdot \exp[-\text{Alpha} \cdot T(n)]$$

(Universal Cosmic Wavefunction or IEMR=Inverse-Energy-Magnetocharge-Relation for Superstring HE(8x8))

Aleph-Null:  $\lim_{n \rightarrow \infty} \{T(n)\} = \infty$

Aleph-All:  $\lim_{n \rightarrow -\infty} \{T(n)\} = 1$

$$|X+Y|=|XY| = -i^2 = 1$$

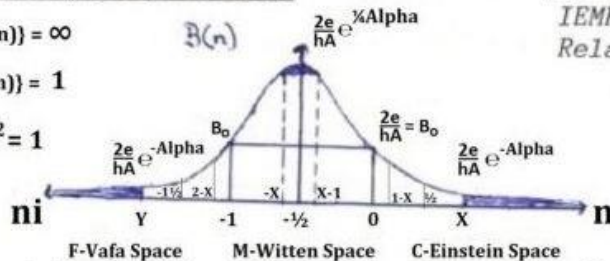

The universe is 'frozen' in M-Space at the X-coordinate for which  $T(n)=1$  and imaged in the Y-coordinate as imaginary time  $n_i$  as function  $B(n)$

12D-9D/6D-flat-spheroidal 11D-8D/5D-hyperbolic-mirror 10D-7D/4D-spheroidal-flat

$T(n)=n(n+1)$  defines the summation of particle histories (Feynman) and  $B(n)$  establishes the  $v/c$  ratio of Special Relativity as a Binomial Distribution about the roots of the  $XY=i^2$  boundary condition in a complex Riemann Analysis of the Zeta Function about a 'Functional Riemann Bound'  $FRB=-\frac{1}{2}$ .

We can define the Euler-Riemann-Summation, which defines the "Mixing of the Count" in linking Arithmetic Progression to the Factorial "!".

Define:  $E_0=0$  as the singularity, then for any integer  $n$ , we find for the Harmonic Form of Riemann's Zeta-Function:  $\zeta(z) = \sum_{n=1}^{\infty} 1/n^z \Rightarrow 1/1^k + 1/2^k + 1/3^k + \dots + 1/n^k$

$$T_{E_n}^k = n^k \cdot T_{E_{n-1}}^k + [(n-1)!]^k \quad \text{for the } n\text{th term (numerator)}$$

and

$$S_{E_n}^k = T_{E_n}^k / (n!)^k \quad \text{for the } n\text{th sum per } n \text{ (denominator } [n!]^k)$$

The singularity so mixes the interval  $[1,0]$  with the FRB= $-\frac{1}{2}$  becoming the real part  $n_{\frac{1}{2}}$  as the central limit or pole, about which the Zero's of the Riemann-Zeta-Function propagate.

The first annulus in the Riemann-Euler-Harmonic so phasemixes the numbers 2 and 1 and the  $n$ th number is mixed with  $(n+1)$  as crystallised in the Feynman-Path-Integral or  $T(n)=1$  definition of  $n(n+1)$ , as the summation of all possible particular histories and the Feynman Unified-Field-Model for Quantum Mechanics. This also maps  $SE_{ps}$  onto Super- $SE_{ps}$  in the extension of the Factors which define the Omnispatial definition process in F-Space.

The  $n$ th term of  $SE_{ps}$  is given by:  $\frac{|-Y^n - X^n|}{(5)^{\frac{1}{2}}}$  via Maclaurin-Expansion of the coefficients (E-Factors) in:  $f(x) = 1 + x + 2x^2 + 3x^3 + \dots = \sum_{n=1}^{\infty} S_n \cdot x^{n-1}$ .  
 $x \cdot f(x) + x^2 \cdot f(x) = f(x) - 1$  and via  $(a-b)(a+b)$ ;  $f(x) = a/(x-X) + b/(x-Y)$   
 $a = -b = 1/(Y-X)$  with  $X-Y = (5)^{\frac{1}{2}}$ .

Super- $SE_{ps}$  is the sequence: 2,1,3,4,7,11,18,29,... whose  $n$ th term is given by

$$\frac{|-Y^{2n} - X^{2n}|}{|-Y^n - X^n|} = \left| \frac{T_{2n}}{T_n} \right| \quad \text{for } n=1,2,3,\dots; T_{2n=0}=2 \text{ mapping } T_{n=0}=0.$$

The combined  $SE_{ps}$ -Super $SE_{ps}$  sequence of experience factors then is written as:

$$\{S_n, SS_n\} = \{(S_0=0, SS_0=2=S_3); (S_1=1=SS_1=S_2); (S_4=3=SS_2); (SS_3=4, S_4); (SS_4=7, S_3); (S_5 SS) \dots\}$$

The mappings between C-and F-Space so are "well behaved" for  $n > 2$  in Super- $SE_{ps}$ , as seen in the Infinity-Matrix, which maps  $SE_{ps}$  onto Super- $SE_{ps}$  in the specification of the "Mixing of the Count" as given by the Euler-Riemann-Harmonic.

↑	0	0	1?	n=∞	via 0+0=∞=1*=0*=1	3	-4	-1	n=-1	= i <sup>2</sup>	↑
1	0*	1	n=0	via (1,1,1)	-1	3	2*	n=0			a+ib
1	1	2	n=1	via (1,1,10=2*=0/0=1*	2*	-1	1	n=0*	reflection		
2	1	3	n=2		1	2*	3	n=0			
3	2	5	n=3	well behaved	3	1	4	n=1			

**SEps**  
**Fibonacci Series : {0,1,1,2,3,5,8,13,21,34,55,...}**

**Super-SEps**  
**Lucas Series : {2,1,3,4,7,11,18,29,47,76,123,...}**

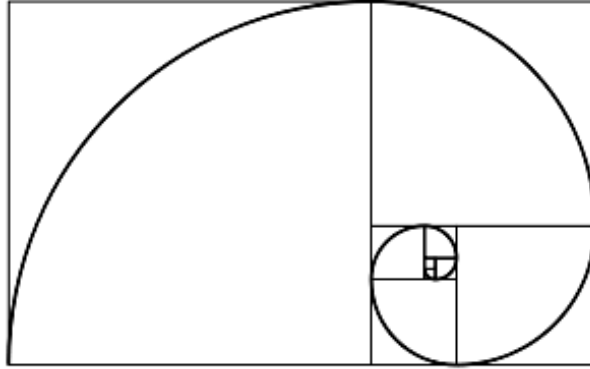

$$X = \frac{1}{2}(\sqrt{5}-1) = 0.618033\dots \text{ and } Y = -(X+1) = -\frac{1}{2}(\sqrt{5}+1) = -1.618033\dots$$

$-X(X-1) = 0.236067\dots$  in analogue to  $X(X+1) = 1 = T(n)$  and  $XY = X+Y = -1 = i^2$  as the complex origin. But  $0.236067\dots = X^3$ , so defining the 'New Unity' as  $\#^3 = \text{Alpha}$  and the precursive unity as the Cube root of Alpha or as  $\#$  in the symmetry  $\#:\#^3 = \text{SNI}:\text{EMI} = \{\text{Strong Nuclear Interaction Strength}\}/\{\text{Electromagnetic Interaction Strength}\}$ .

The Strong-Interaction-Constant  $\text{SIC} = \sqrt{\text{Alpha}} = \sqrt{e^2/2\epsilon_0 hc} = \sqrt{60\pi e^2/h}$  in standard and in string units, reduces the SNI fine structure constant  $\#$  by a factor  $\text{Alpha}^{1/6}$ ; that is in the sixth root of alpha and so relates the SIC at the post quantization level as  $\#$  to the pre-quantum epoch as  $\text{SIC} = \sqrt{\text{Alpha}} = \#^{3/2}$ .

The SNI is therefore so 11.7 times weaker at the XL-Boson 'Grand-Unification-Time' SEW.G of heterotic superstring class HO(32), then at the  $E_{ps}E_{ss}$  time instantaneity S.EW.G of the superstring of the Quantum Big Bang in heterotic class HE(8x8) {this is the string class of Visi in the group theories}.

This then is the Bosonic Gauge Heterosis Coupling between superstrings HO(32) and HE(8x8). The coupling between superstrings IIA (ECosmic and manifesting the cosmic rays as superstring decay products) and IIB (Magnetic Monopole) derives directly from the  $B(n)$ , with  $B(n=0) = J_0 = 2e/hA$

$= 0.9927298 \text{ 1/J}^*$  or  $6.2705 \times 10^9 \text{ GeV}^*$  and representative of the ECosmic string class and the super high energy resonances in the cosmic ray spectrum, bounded in the monopolar resonance limit of  $2.7 \times 10^{16} \text{ GeV}^*$ .

The Unity of the SNI transforms to  $[1-X] = X^2$  and the EMI transforms as the Interaction of Invariance from X to X.

The Weak Nuclear Interaction or WNI as  $X^2$  becomes  $[1+X] = 1/X$  and the Gravitational Interaction or GI transforms as  $X^3$  transforms to  $[2+X] = 1/X^2$  by modular symmetry between X and Alpha and the encompassing Unification Unity:  $[1-X][X][1+X][2+X] = 1$ .

This Unification Polynomial  $U(u) = u^4 + 2u^3 - u^2 - 2u + 1 = 0$  then has minimum roots (as quartic solutions) at the  $\text{Phi} = X$  and the Golden Mean  $Y = -(1+X)$ .

This sets the coupling between SNI and EMI as X; the coupling between EMI and WNI becomes  $X^2$  and the coupling between WNI and GI then is again X.

The general Force-Interaction-Ratio so is:  $\text{SNI}:\text{EMI}:\text{WNI}:\text{GI} = \text{SEWG} = \#:\#^3:\#^{18}:\#^{54}$ .

Typical decay rates for the nested fundamental interactions then follow the order in the light path  
 $lp = ct_k$ :

$$t_{SNI} = R_e/c = 2.777... \times 10^{-15} \text{ m}^*/3 \times 10^8 \text{ m}^*/s^* = 0.925925... \times 10^{-24} \text{ s}^* \sim (\text{Order } 10^{-23} \text{ s}^*)$$

$$t_{EMI} = t_{SNI}/\alpha = 10^{-23} \text{ s}^*/(7.30 \times 10^{-3}) = 1.37 \times 10^{-21} \text{ s}^* \sim \text{Order } (10^{-21} \text{ s}^*)$$

$$t_{WNI} = t_{SNI}/\alpha^6 = 10^{-23} \text{ s}^*/(1.51 \times 10^{-13}) = 6.62 \times 10^{-11} \text{ s}^* \sim \text{Order } (10^{-10} \text{ s}^*)$$

$$t_{GI} = t_{SNI}/\alpha^{18} = 10^{-23} \text{ s}^*/(3.44 \times 10^{-39}) = 2.91 \times 10^{15} \text{ s}^* \sim \text{Order } (10^{15} \text{ s}^* \sim 92 \text{ million years characterizing the half-lives of trans uranium elements like Plutonium Pu-244 at } 79 \times 10^6 \text{ y})$$

This is the generalization for the cubic transform:  $x \rightarrow x^3$  with the Alpha-Unity squaring in the functionality of the WNI and defining G-Alpha as Alpha<sup>18</sup> in the Planck-Mass transforming in string bosonic reduction to a fundamental nucleonic mass (proton and neutrons as up-down quark conglomerates and sufficient to construct a physical universe of measurement and observation):

$m_c = m_{\text{planck}} \text{Alpha}^9$  from the electromagnetic string unification with gravitation in the two dimensionless fine structures:

For Gravitational Mass Charge from higher D Magnetic Charge:  $1 = 2\pi G_o \cdot m_{\text{planck}}^2/hc$

For Electromagnetic Coulomb Charge as lower D Electric Charge:  $\text{Alpha} = 2\pi k e^2/hc$

Alpha as the universal primary constant of creation, then becomes defined via the Riemann Analysis from  $XY = i^2$  definition, reflecting in modulation in the statistical renormalization of the B(n) as the probability distributions in quantum wave mechanics, however.

U(u) has its maximum at  $u = -\frac{1}{2} = \text{FRB}$  for  $U(-\frac{1}{2}) = 25/16 = (5/4)^2$  for the B(n) supersymmetry.

A symmetry for B(n) is found for  $B(n) = i^2 = -1$ .

$(u)=0$  for an  $\text{FRB}=\frac{1}{2}$  indicating a cosmological relationship to the Riemann hypothesis with respect to the distribution of prime numbers and Riemann's zeta function.

The derivation of the HBRMI draws upon this definition process and sets the coupling angle as  $\text{Arcsin}(X/\varpi)$  for a Unitary 'Force'  $\varpi = (\#f_G) \cdot c f_{ps} E\text{-Alpha}/\text{Alpha}$  and with the electron mass replacing the fundamental nucleon mass  $m_c$  in the definition of E-Alpha.

A disassociated GI unifies with the WNI in the L-Boson and is supersymmetric to an intrinsic unification between the SNI and the EMI as the X-Boson for the duality  $f_G f_S = 1$  in modular definition of a characteristic GI-mass  $\#f_G$  as the disassociated elementary gauge field interaction.

The transformation of the 5 superstring classes proceeds in utilizing the self-duality of superstring IIB as the first energy transformation of the Inflaton in the Planck string class I trans mutating into the monopole string class IIB.

**Wikipedia reference:**

F-theory is a branch of [string theory](#) developed by [Cumrun Vafa](#).<sup>[1]</sup> The new [vacua](#) described by F-theory were discovered by Vafa and allowed string theorists to construct new realistic vacua — in the form of F-theory [compactified](#) on elliptically fibered [Calabi–Yau](#) four-folds. The letter "F" supposedly stands for "Father".<sup>[2]</sup>

F-theory is formally a 12-dimensional theory, but the only way to obtain an acceptable background is to [compactify](#) this theory on a [two-torus](#). By doing so, one obtains [type IIB superstring theory](#) in 10 dimensions. The [SL\(2,Z\) S-duality](#) symmetry of the resulting type IIB string theory is manifest because it arises as the group of [large diffeomorphisms](#) of the two-dimensional [torus](#)

The transformation of the 5 superstring classes proceeds in utilizing the self-duality of superstring IIB as the first energy transformation of the Inflaton in the Planck string class I trans mutating into the monopole string class IIB and residing in the 2-toroidal bulk space of Vafa as our Riemann 3-dimensional surface describing the VPE-ZPE of the micro quantum of the qbb.

The  $E_{ps}$ -Weyl wormhole of topological closure so is holographically and conformally mapped onto the bulk space in 12 dimensions as a braned volumar evolving by mirror duality of the 11dimensional closed AdS membrane space of Witten's M-space as Vafa's F-space and mirroring the hyperbolic topology of 10-dimensional C-space as an open dS cosmology in an overall measured and observed Euclidean flatness of zero curvature.

Vafa's F-space so can be named the omniverse hosting multiple universes which are nested in parallel time space and defined initial and boundary conditions valid and applicable for all universes as a multiversal parameter space.

The quantization of mass  $m$  so indicates the coupling of the Planck Law in the frequency parameter to the Einstein law in the mass parameter.

The postulated basis of M-Theory utilizes the coupling of two energy-momentum eigenstates in the form of the modular duality between so termed 'vibratory' (high energy and short wavelengths) and 'winding' (low energy and long wavelengths) self-states.

The 'vibratory' self-state is denoted in:  $E_{ps} = E_{\text{primary sourcesink}} = hf_{ps} = m_{ps}c^2$  and the 'winding' and coupled self-state is denoted by:  $E_{ss} = E_{\text{secondary sinksources}} = hf_{ss} = m_{ss}c^2$ .

The F-Space Unitary symmetry condition becomes:  $f_{ps}f_{ss} = r_{ps}r_{ss} = (\lambda_{ps}/2\pi)(2\pi\lambda_{ss}) = 1$

The coupling constants between the two eigenstates are so:

$E_{ps}E_{ss} = h^2$  and  $E_{ps}/E_{ss} = f_{ps}^2 = 1/f_{ss}^2$  The Supermembrane  $E_{ps}E_{ss}$  then denotes the coupled superstrings in their 'vibratory' high energy and 'winded' low energy self-state within an encompassing super eigen state of quantum entanglement.

The coupling constant for the vibratory high energy describes a maximized frequency differential over time in  $df/dt|_{\text{max}} = f_{ps}^2$  and the coupling constant for the winded low energy describes its minimized reciprocal in  $df/dt|_{\text{min}} = f_{ss}^2$ .

F-Theory also crystallizes the following string formulations from the  $E_{ps}E_{ss}$  super brane parameters.

**Electromagnetic Fine structure: (Planck-Stoney QR units\*).....[Eq.XII-1]**

$\alpha_e = 2\pi k_e e^2 / hc = e^2 / 2\epsilon_0 hc = \mu_0 e^2 c / 2h = 60\pi e^2 / h$ .....[Eq.XII-2]

**Gravitational Fine structure (Electron):  $\alpha_g = 2\pi G_0 m_e^2 / hc = \{m_e / m_{\text{planck}}\}^2$ .....[Eq.XII-3]**

**Gravitational Fine structure (Primordial Nucleon):  $\alpha_n = 2\pi G_0 m_c^2 / hc$ .....[Eq.XII-4]**

**Gravitational Fine structure (Planck Boson):  $\alpha_{\text{planck}} = 2\pi G_0 m_{\text{planck}}^2 / hc$ .....[Eq.XII-5]**

$$1/E_{ps} = e^* = 2R_e c^2 = \sqrt{4\alpha_e hc^2 / 2\pi G_0 m_e^2} = 2e\sqrt{\alpha_e} [m_p / m_e] = 2e\sqrt{\alpha_e / \alpha_g} = \{2e^2 / m_e\} \sqrt{(k_e / G_0)} = 2e^2 / G_0 m_e$$

$$= e^2 / 2\pi \epsilon_0 m_e \text{ for } G_0 = 1/k_e = 4\pi \epsilon_0$$

for a cosmological unification of fine structures in unitary coupling

$$E^* \cdot e^* = 1 \text{ in } [Nm^2/kg^2] = [m^3s^{-2}/kg] = 1/[Nm^2/C^2] = [C^2m^{-3}s^2/kg] \text{ for } [C^2] = [m^6/s^4]$$

$$\text{and } [C] = [m^3/s^2]. E_{ps} = 1/E_{ss} = 1/e^* = \sqrt{\alpha_g / \alpha_e} / 2e = G_0 m_e / 2e^2$$

Here  $e^*$  is defined as the inverse of the sourcesink vibratory superstring energy quantum  $E_{ps} = E^*$  and becomes a New Physical Measurement Unit is the Star Coulomb ( $C^*$ ) and as the physical measurement unit for 'Physical Consciousness'.

$R_e$  is the 'classical electron radius' coupling the 'point electron' of Quantum- Electro-Dynamics (QED) to Quantum Field Theory (QFT) and given in the electric potential energy of Coulomb's Law in:  $m_e c^2 = k_e e^2 / R_e$ ; and for the electronic monopolar rest mass  $m_e$ .

Alpha  $\alpha$  is the electromagnetic fine structure coupling constant  $\alpha = 2\pi k_e e^2 / hc$  for the electric charge quantum  $e$ , Planck's constant  $h$  and lightspeed constant  $c$ .

$G_0$  is the Newtonian gravitational constant as applicable in the Planck-Mass

$$m_p = \sqrt{(hc / 2\pi G_0)} \text{ and the invariance of the gravitational parameter } G(n)M(n) = G_0 X^n \cdot m_c Y^n.$$

As the Star Coulomb unit describes the inverse sourcesink string energy as an elementary energy transformation from the string parametrization into the realm of classical QFT and QED, this transformation allows the reassignment of the Star Coulomb ( $C^*$ ) as the measurement of physical space itself.

The following derivations lead to a simplified string formalism as boundary- and initial conditions in a de Sitter cosmology encompassing the classical Minkowskian-Friedmann spacetimes holographically and fractally in the Schwarzschild metrics.

The magnetic field intensity  $B$  is classically described in the Biot-Savart Law:

$$B = \mu_0 qv / 4\pi r^2 = \mu_0 i / 4\pi r = \mu_0 q\omega / 4\pi r = \mu_0 Nef / 2r$$

for a charge count  $q = Ne$ ; angular velocity  $\omega = v/r = 2\pi f$ ; current  $i = dq/dt$  and the current element  $i \cdot dl = dq \cdot (dl/dt) = v dq$ .

The Maxwell constant then can be written as an (approximating) fine structure:

$$\mu_0 \epsilon_0 = 1/c^2 = (120\pi/c) (1/120\pi c) \text{ to crystallize 'free space impedance' } Z_0 = \sqrt{(\mu_0 / \epsilon_0)} = 120\pi \sim 377 \text{ Ohm } (\Omega).$$

This vacuum resistance  $Z_0$  so defines a 'Unified Action Law' in a coupling of the electric permittivity component ( $\epsilon_0$ ) of inertial mass and the magnetic permeability component ( $\mu_0$ ) of gravitational mass in the Equivalence Principle of General Relativity.

A unified self-state of the pre-inertial (string- or brane) cosmology so is obtained from the fine structures for the electric- and gravitational interactions coupling a so defined electropolar mass to magnetopolar mass, respectively.

The Planck-Mass is given from Unity  $1 = 2\pi G m_p^2 / hc$  and the Planck-Charge derives from  $\text{Alpha} = 2\pi k_e e^2 / hc$  and where  $k_e = 1/4\pi\epsilon_0$  in the electromagnetic fine structure describing the probability interaction between matter and light (as about 1/137).

The important aspect of alpha relates to the inertia coupling of Planck-Charge to Planck-Mass as all inertial masses are associated with Coulombic charges as inertial electropoles; whilst the stringed form of the Planck-Mass remains massless as gravitational mass. It is the acceleration of electropoles coupled to inertial mass, which produces electromagnetic radiation (EMR); whilst the analogy of accelerating magnetopoles coupled to gravitational mass and emitting electromagnetic monopolar radiation (EMMR) remains hitherto undefined in the standard models of both cosmology and particle physics.

But the coupling between electropoles and magnetopoles occurs as dimensional intersection, say between a flat Minkowskian spacetime in 4D and a curved de Sitter spacetime in 5D (and which becomes topologically extended in 6-dimensional Calabi-Yau tori and 7-dimensional Joyce manifolds in M-Theory).

The formal coupling results in the 'bounce' of the Planck-Length in the pre-Big Bang scenario, and which manifests in the de Broglie inflaton-instanton.

The Planck-Length  $L_p = \sqrt{(hG/2\pi c^3)}$  'oscillates' in its Planck-Energy  $m_p = h/\lambda_p c = h/2\pi c L_p$  to give

$\sqrt{\text{Alpha}} \cdot L_p = e/c^2$  in the coupling of 'Stoney units' suppressing Planck's constant 'h' to the 'Planck units' suppressing charge quantum 'e'.

Subsequently, the Planck-Length is 'displaced' in a factor of about  $11.7 = 1/\sqrt{\text{Alpha}} = \sqrt{(h/60\pi)}/e$  and using the Maxwellian fine structures and the unity condition  $k_e G_0 = 1$  for a dimensionless string coupling  $G_0 = 4\pi\epsilon_0$ , describing the 'Action Law' for the Vacuum Impedance as  $\text{Action} = \text{Charge}^2$ , say via dimensional analysis:

$Z_0 = \sqrt{([Js^2/C^2m])/[C^2/Jm]} = [Js]/[C^2] = [\text{Action}/\text{Charge}^2]$  in Ohms [ $\Omega = V/I = Js/C^2$ ] and proportional to  $[h/e^2]$  as the 'higher dimensional source' for the manifesting superconductivity of the lower dimensions in the Quantum Hall Effect ( $\sim e^2/h$ ), the conductance quantum ( $2e^2/h$ ) and the Josephson frequencies ( $\sim 2e/h$ ) in Ohms [ $\Omega$ ].

This derivation so indicates an electromagnetic cosmology based on string parameters as preceding the introduction of inertial mass (in the quantum Big Bang) and defines an intrinsic curvature within the higher dimensional (de Sitter) universe based on gravitational mass equivalents and their superconductive monopolar current flows.

A massless, but monopolar electromagnetic de Sitter universe would exhibit intrinsic curvature in gravitational mass equivalence in its property of closure under an encompassing static Schwarzschild metric and a Gravitational String-Constant  $G_0 = 1/k_e = 1/30c$  (as given in the Maxwellian fine structures in the string space).



In other words, the Big Bang manifested inertial parameters and the matter content for a subsequent Cosmo evolution in the transformation of gravitational 'curvature energy', here called gravita as precursor for inertia into inertial mass seedlings, both however describable in Black Hole physics and the Schwarzschild metrics.

The Gravitational Fine structure so derives in replacing the Planck-Mass  $m_P$  by a proto-nucleonic mass:  $m_c = \sqrt{(hc/2\pi G_0) \cdot f(\alpha)} = f(\text{Alpha}) \cdot m_P$  and where  $f(\text{Alpha}) = \text{Alpha}^9$ .

The Gravitational fine structure, here named Omega, is further described in a five folded supersymmetry of the string hierarchies, the latter as indicated in the following below in excerpt.

This pentagonal supersymmetry can be expressed in a number of ways, say in a one-to-one mapping of the Alpha fine structure constant as invariant X from the Euler Identity:  $X+Y = XY = -1 = i^2 = \exp(i\pi)$ .

One can write a Unification Polynomial:  $(1-X)(X)(1+X)(2+X) = 1$  or  $X^4+2X^3-X^2-2X+1 = 0$  to find the coupling ratios:  $f(S) | f(E) | f(W) | f(G) = \# | \#^3 | \#^{18} | \#^{54}$  from the proportionality

$$\# | \#^3 | \{[(\#^3)^2]\}^3 | \{[(\#^3)^2]\}^3 = \text{Cube root}(\text{Alpha}) : \text{Alpha} : \text{Cuberoot}(\text{Omega}) : \text{Omega}.$$

The Unification polynomial then sets the ratios in the inversion properties under modular duality:

$$(1)[\text{Strong short}] | (X)[\text{Electromagnetic long}] | (X^2)[\text{Weak short}] | (X^3)[\text{Gravitational long}] \text{ as } 1 | X | X^2 | X^3 \\ = (1-X) | (X) | (1+X) | (2+X).$$

Unity 1 maps as (1-X) transforming as f(S) in the equality  $(1-X) = X^2$ ; X maps as invariant of the function f(E) in the equality  $(X) = (X)$ ;  $X^2$  maps as (1+X) transforming as f(W) in the equality  $(1+X) = 1/X$ ; and  $X^3$  maps as (2+X) transforming as f(G) in the equality  $(2+X) = 1/X^2 = 1/(1-X)$ . The mathematical pentagonal supersymmetry from the above then indicates the physicalised T-duality of M-theory in the principle of mirror-symmetry and which manifests in the reflection properties of the heterotic string classes HO(32) and HE(64), described further in the following.

Defining  $f(S) = \# = 1/f(G)$  and  $f(E) = \#^2 \cdot f(S)$  then describes a symmetry breaking between the 'strong S' f(S) interaction and the 'electromagnetic E' f(E) interaction under the unification couplings.

This couples under modular duality to  $f(S) \cdot f(G) = 1 = \#^{55}$  in a factor  $\#^{53} = f(S)/f(G) = \{f(S)\}^2$  of the 'broken' symmetry between the long range- and the shortrange interactions.

SEWG = 1 = Strong-Electromagnetic-Weak-Gravitational as the unified supersymmetric identity then decouples in the manifestation of string-classes in the de Broglie 'matter wave' epoch termed inflation and preceding the Big Bang, the latter manifesting at Weyl-Time as a string transformed Planck-Time as the heterotic HE(64) class.

As SEWG indicates the Planck-String (class I, which is both open ended and closed), the first transformation becomes the suppression of the nuclear interactions sEwG and describing the self-dual monopole (string class IIB, which is loop-closed in Dirichlet brane attachment across dimensions say Kaluza-Klein  $R^5$  to Minkowskian  $R^4$  or Membrane-Space  $R^{11}$  to String Space  $R^{10}$ ).

The monopole class so 'unifies' E with G via the gravitational fine structure assuming not a Weylian fermionic nucleon, but the bosonic monopole from the  $kG_0 = 1$  initial-boundary condition

$$Gm_M^2 = k_e e^2 \text{ for } m_M = k_e e = 30[ec] = m_P \sqrt{\text{Alpha}}.$$

The Planck-Monopole coupling so becomes  $m_P/m_M = m_P/30[ec] = 1/\sqrt{\alpha}$  with  $f(S) = f(E)/\#^2$  modulating

$f(G) = \#^2/f(E)=1/\# \leftrightarrow f(G)\{f(S)/f(G)\} = \#$  in the symmetry breaking  $f(S)/f(G) = 1/\#^{53}$  between short (nuclear asymptotic) and long (inverse square).

The short-range coupling becomes  $f(S)/f(W) = \#/\#^{18} = 1/\#^{17} = \text{Cube root}(\alpha)/\alpha^6$  and the long-range coupling is  $\alpha/\Omega = 1/\alpha^{17} = \#^3/\#^{54} = 1/\#^{51} = 1/(\#^{17})^3$ .

The strong nuclear interaction coupling parameter so becomes about 0.2 as the cube root of alpha and as measured in the standard model of particle physics in the form of an energy dependent 'running coupling constant' and which takes a value of  $\alpha_Z = 0.1184$  at the energy level of the  $Z^0$  weakon at about 92 GeV.

The monopole quasi-mass  $[ec]$  describes a monopolar source current  $ef$  from the unification identity  $1/e * f_{ps} = h = E * f_{ps}$  as a fine structure for Planck's constant  $h$ , manifesting for a displacement  $\lambda=c/f$ . This is of course the GUT unification energy of the Dirac Monopole at precisely  $[c^3]$  eV or  $2.7 \times 10^{16}$  GeV and the upper limit for the Cosmic Ray spectra as the physical manifestation for the string classes: {I, IIB, HO(32), IIA and HE(64) in order of modular duality transmutation}.

The transformation of the Monopole string into the XL-Boson string decouples Gravity from sEwG in sEw.G in the heterotic superstring class HO(32). As this heterotic class is modular dual to the other heterotic class, HE(64), it is here, that the proto nucleon mass is defined in the modular duality of the heterosis in:  $\Omega = \alpha^{18} = 2\pi G_0 m_c^2 / hc = (m_c / m_P)^2$ .

The HO(32) string bifurcates into a quarkian X-part and a leptonic L-part, so rendering the bosonic scalar spin as fermionic half spin in the continuation of the 'breaking' of the supersymmetry of the Planckian unification. Its heterosis with the Weyl-string then decouples the strong interaction at Weyl-Time for a Weyl-Mass  $m_w$ , meaning at the time instanton of the end of inflation or the Big Bang in sEw.G becoming s.Ew.G.

The X-Boson then transforms into a fermionic proto nucleon triquark-component (of energy  $\sim 10^{-27}$  kg or 560 MeV) and the L-Boson transforms into the proto-muon (of energy about 111 MeV).

The electroweak decoupling then occurs from a time marker about  $1/140^{\text{th}}$  of a second from the QBBS at a temperature of  $1.658 \times 10^{15}$  K\* for a Fermi-Expectation Energy about  $1/365$  seconds after the Big Bang at a temperature of about  $3.4 \times 10^{15}$  K and at a 'Higgs Boson' energy of about 298 GeV.

A Bosonic decoupling preceded the electroweak decoupling about 2 nanoseconds into the cosmogenesis at the Weyl-temperature of so  $T_{\text{Weyl}} = T_{\text{max}} = E_{\text{Weyl}}/k_B = 1.4 \times 10^{20}$  K as the maximum Black Hole temperature maximized in the Hawking MT modulus and the Hawking-Gibbons formulation:

$M_{\text{critical}} T_{\text{min}} = \frac{1}{2} M_{\text{Planck}} T_{\text{Planck}} = (hc/2\pi G_0)(c^2/2k_B) = hc^3/4\pi k_B G_0$  for  $T_{\text{min}} = 1.4 \times 10^{-29}$  K and Boltzmann constant  $k_B$ .

The Hawking Radiation formula results in the scaling of the Hawking MT modulus by the factor of the 'Unified Field' spanning a displacement scale of  $8\pi$  radians or  $1440^\circ$  in the displacement of  $4\lambda_{ps}$ .

The XL-Boson mass is given in the quark-component:  $m_x = \#^3 m_{\text{Weyl}}/[ec] |_{\text{mod}} = 1.9 \times 10^{15}$  GeV modulated in  $(\text{SNI/EMI} = \sqrt[3]{\{\alpha\}/\{\alpha\}})$ , the intrinsic unified Strong-Electroweak Interaction-Strength for the Kernel part in the Quark-Lepton hierarchy.

The LX-Boson mass is given in the lepton-component:  $m_L = \Omega \cdot [ec] / \#^2 = ([\Omega] \times [ec]) / (m_{ps} \cdot \sqrt[3]{\alpha^2}) = \#^{52} [ec / m_{Weyl}] \sim 111 \text{ MeV}$  in functional operators  $f(G) \times f(S) = 1$  for the Ring part in the Quark-Lepton hierarchy.

In particular  $f(G) / m_{\text{planck}} \leftrightarrow \#^2 / [ec]$  for  $\#(m_{ps} / m_{\text{planck}}) f(G)$  and the X-Boson and  $f(S) \cdot m_{\text{planck}} \leftrightarrow [ec] / \#^2$  for  $\#^{54} [(m_{\text{planck}} / m_{ps}) f(S)]$  for the L-Boson.

The X-Boson's mass is:  $([\alpha] \times m_{ps} / [ec])$  modulated in  $(SNI/EMI = \sqrt[3]{[\alpha] / [\alpha]})$ , the intrinsic unified Strong-Electroweak Interaction-Strength and the L-Boson's mass in:  $([\Omega] \times [ec]) / (m_{ps} \cdot \sqrt[3]{\alpha^2})$ .

When the heavy electron known as the muon was accidentally discovered in the late 1930s, Nobel physicist Isidor Isaac Rabi famously remarked, "Who ordered that?"

It is this lepton component which necessitates the existence of the muon (and the tauon and their neutrino partners as constituents of the weak interaction gauge bosons) as a 'heavy electron', as the quantum geometry defines the muon mass in a decoupling of the  $L_1$  energy level given in a diquark hierarchy and based on a quantum geometry of the quantum relativity:

Ten DIQUARK quark-mass-levels crystallize, including a VPE-level for the K-IR transition and a VPE-level for the IR-OR transition:

The K-Means define individual materializing families of elementary particles:

a (UP/DOWN-Mean) sets the (PION-FAMILY:  $\pi^0, \pi^+, \pi^-$ ).

a (STRANGE-Mean) specifies the (KAON-FAMILY:  $K^0, K^+, K^-$ ).

a (CHARM-Mean) defines the (J/PSI=J/Ψ-Charmonium-FAMILY).

a (BEAUTY-Mean) sets the (UPSILON=Y-Bottomium-FAMILY).

a (MAGIC-Mean) specifies the (EPSILON=E-FAMILY).

a (DAINTY-Mean) bases the (OMICRON-O-FAMILY).

a (TRUTH-Mean) sets the (KOPPA=K-Toponium-FAMILY) and

a (SUPER-Mean) defines the final quark state in the (HIGGS/CHI=H/X-FAMILY).

Quark Level	Kernel-Energy in MeV	K-Mean(x½) in MeV*	Ring-Energy in MeV*	IR-OR Mean in MeV*	Ground state K-Mean-IR-OR-Mean	Comments
VPE-Level [K-IR]	26.4924-29.9618	$g_{l2} = 4.11355$	2.8175-3.1865	$L_2 = 1.5010 = m_u$	12.6126	K-IR VPE
VPE-Level [IR-OR]	86.5334-97.8657	$g_{l1} = 46.100$	9.2030-10.408	$L_1 = 4.9028 = m_d$	$GS_2 = GS_{VPE} = 41.198$ $ms = 2g_{l1} + L_1 + L_2$ $= g_{l1} + g_{l2} + 2L_{u,d} + L_1 + L_2$ $= 98.645; 98.604$ $\Delta_s = 0.041 = g_{l2} - g_{l1} + 2L_{u,d}$	IR-OR VPE Ground-OR electron level
Quark UP/DOWN-Level u=K; d=K+IR ubar=Kbar; dbar=Kbar+IRbar	282.6487-319.6637	$g_{u,d} = 150.5781$	30.060-33.997	$L_{u,d} = 16.014$	$GS_3 = GS_{u,d} = 134.5641$ Pionium	K-KIR basis
Quark STRANGE-Level s=K+OR sbar=Kbar+ORbar	923.2302-1,044.13	$g_s = 491.8401$	<b>98.187-111.045</b> muon energy	$L_s = 52.308$ $L_2 + L_1 + 2L_{u,d} + L_s = 90.740 + \Delta$ $= m_s + \Delta \{L_2 \pm L_1\}$ <b>92.241-97.144</b>	$GS_4 = GS_s = 439.5321$ Kaonium	KIR-KOR basis 1st (K)-OR- Muon level d↔s KIR↔KOR Resonance
Diquark CHARM-Level c=U.uubar=uu.uubar cbar=Ubar.u=(uu)bar.u	3,015.59-3,410.51	$g_{cu} = 1,606.53$ $g_{cu} - L_{cu} - g_{u,d} = m_{cu}^*$ <b>= 1,285.09</b>	320.71-362.71	$L_{cu} = 170.86$	$GS_5 = GS_{cu} = 1,435.67$ Charmonium Pole mass $= GS_{cu} + 0.L_{cu} = 1,435.67$	<b>Active singlet apparent</b>
Diquark BEAUTY-Level BOTTOM-Level b=(ud)bar=(ud).ubar bbar=(ud)=(ud)bar.u	9,849.99-11,139.93	$g_b = 5,247.48$ $g_b - L_b - g_s = m_b^*$ <b>= 4,197.56</b>	1,047.6-1,184.7	$L_b = 558.08$	$GS_6 = GS_b = 4,689.40$ Bottonium Pole mass $= GS_b + 0.L_b + \frac{1}{2}(g_{l1} + g_{l2}) = 4,719.51$	<b>Active doublet apparent</b>
Diquark MAGIC-Level M=(us)bar=(us).ubar Mbar=(us)=(us)bar.u	32,173.6-36,386.9	$g_M = 7,140.13$	3,421.7-3,869.8	$L_M = 1,822.88$ max Tauon energy	$GS_7 = GS_M = 15,317.25$ Magiconium Pole mass $= GS_M + \frac{1}{2}L_M + \frac{1}{2}(g_{l1} + g_{l2}) + \frac{1}{2}(L_1 + L_2) = 16,262.00$	Suppressed doublet-1 in 2nd K-OR-Tauon level M=us and M.Mbar=VPE in b.bbar resonance
Diquark DAINTY-Level D=(dd)bar=(ud).dbar Dbar=(dd)=(ud)bar.d	105,090-118,852	$g_D = 55,985.5$	11,177-12,640	$L_D = 5,954.25$	$GS_8 = GS_D = 50,031.25$ Daintonium Pole mass $= GS_D + 0.L_D + (g_{l1} + g_{l2}) = 50,091.46$	Suppressed triplet 1 in D=dd and D.Dbar=VPE in no IROR oscillation
Diquark TRUTH-Level TOP-Level t=(ds)bar=(ud).sbar tbar=(ds)=(ud)bar.s	343,261-388,214	$g_t = 182,869$ $g_t - L_t + g_s = m_t^*$ <b>= 163,912.6</b>	36,506-41,287	$L_t = 19,448.25$	$GS_9 = GS_t = 163,420.75$ Toponium Pole mass $= GS_t + \frac{1}{2}.L_t + (g_{l1} + g_{l2}) + \frac{1}{2}(L_1 + L_2) = 173,208.3$	<b>Active triplet apparent</b>
Diquark SUPER-Level S=(ss)bar =(us)sbar Sbar=(ss)=(us)bar.s	1,120,592-1,268,044	$g_s = 97,159.0$	119,243-134,858	$L_s = 63,525.27$	$GS_{10} = GS_s = 533,633.73$ Superonium Pole mass $= GS_s + L_s + (g_{l1} + g_{l2}) + (L_1 + L_2) = 597,225.6$	suppressed triplet 2 in S=ss and S.Sbar=VPE in no ORIR oscillation

# Quarkian Hierarchies in the Unified Field of Quantum Relativity

Operator  $A\{u;d;s\} \Rightarrow \bar{c}$

$c \Leftarrow$  Operator  $B=A^*\{u^*;d^*;s^*\}$

$$\bar{u}\bar{u} \cdot \bar{u}u = \bar{U} \cdot U \begin{cases} u[+2/3] \\ d[-1/3] \\ s[-1/3] \end{cases} \left\{ \begin{array}{l} [-2/3] dd=\bar{D} \\ [+1/3] ud=b \\ [+1/3] us=M \end{array} \right\} t S \cdot \bar{S} t = \overline{dsss} \cdot sssd$$

$$[-4/3],[+4/3] = [0] \quad [0] \quad [0] \quad [0] = [+4/3],[ -4/3]$$

$$\begin{aligned} \bar{U}u &= \bar{u} \cdot \bar{u}u = \bar{c} \\ \bar{U}d &= \bar{u} \cdot \bar{u}d = \bar{c} + \bar{I}R \\ \bar{U}s &= \bar{u} \cdot \bar{u}s = \bar{c} + \bar{O}R \end{aligned}$$

$$\begin{aligned} St\bar{D} &= \overline{dsss} \cdot dd = c \\ Stb &= \overline{dsss} \cdot ud = c + \bar{I}R \\ StM &= \overline{dsss} \cdot us = c + \bar{O}R \end{aligned}$$

$$\begin{aligned} Uu &= uuu &= \Delta^{++} \\ Ud &= uuu + IR &= \Delta^+ = \Delta^{++} + IR \\ Us &= uuu + OR &= \Sigma^{*+} = \Delta^{++} + OR \end{aligned}$$

$$\begin{aligned} \overline{StD} &= sssd \cdot dd = 2\Delta^{++} + 3IR + 3OR \\ \overline{Stb} &= sssd \cdot ud = 2\Delta^{++} + 2IR + 3OR \\ \overline{StM} &= sssd \cdot us = 2\Delta^{++} + 1IR + 4OR \end{aligned}$$

Matrix  $|VPE| = \begin{bmatrix} K_1 & K_2 \\ L_1 & L_2 \end{bmatrix} = \begin{bmatrix} a & b \\ c & d \end{bmatrix}$  for  $\text{Det}|VPE| = ad - bc = 0 = K_1L_2 - K_2L_1 = (46.100)(1.501) - (14.113)(4.903) = g_{L1}(mu) - g_{L2}(md)$

Matrix  $|md;mu| = \begin{bmatrix} L_1 & L_2 \\ L_1-L_2 & 1 \end{bmatrix} \begin{bmatrix} 1 \\ 1 \end{bmatrix} = \begin{bmatrix} L_1 + L_2 \\ L_1 - L_2 \end{bmatrix}$  for  $\text{Det}|md;mu| = -2L_1L_2$  with  $|md;mu|^{-1} = \frac{-1}{2L_1L_2} \begin{bmatrix} -L_2 & -L_2 \\ -L_1 & L_1 \end{bmatrix} = \frac{-1}{2mdmu} \begin{bmatrix} -mu & -mu \\ -md & md \end{bmatrix}$

Linear dependency given by  $\text{Det}|VPE| = 0$  and  $g_{L1}/g_{L2} = K_1/K_2 = L_1/L_2 = ULM = 3.2665...$   
 For  $k=\{1;2;3;\dots;8;9;10\}=\{2;1;(u,d);s;(cU);b;M;D;t;S\}$ :  
 For 2 Groundstates GS with  $n \geq 2$ :

$$GS_n = GS_{n-1} + 2g_{n-1} + (ULM)^{n-2} \cdot \{1/3e^-, 2/3e^-\} - \Delta_s \quad \{\Delta_s = g_{L2} - g_{L1} + 2L_{u,d} \text{ as the } [u,d]-[s] \text{ strange quark perturbation}\}$$

$d^*=s$  IR-OR Oscillation; i.e. neutron decay

The importance of Kernel-Symmetry so is evidenced in the differentiation of the quarkian permutations and specifying for example the KKIRKOR quark state  $uds$  as a tripartite symmetry of  $u.d.s$  (least stability as SNI-decaying  $\Sigma^0$  resonance) and  $u.s.d$  (EMI-stable  $\Sigma^0$  particle) and  $d.u.s$  (WNI-most stable  $\Lambda^0$  particle).

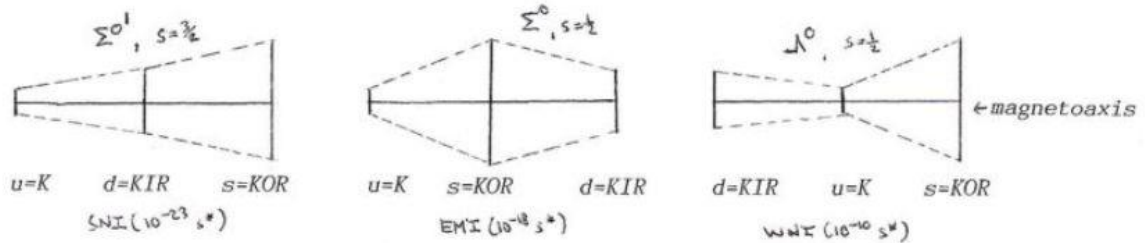

Quark-Gluon Quantum Geometry in the  $uds$ -quark content

particle	most symmetric quantum geometry	basic.symbol.energy partitioning for groundstates $g_k (+\Delta)$	energy values	energy * MeV*	energy SI MeV	particle name
$p^+$	u.d.u=KKIRK	$m_k+[L_2]-[e^-]-\frac{1}{3}[e^-]$	939.776+1.5013-0.5205-0.1735	940.5833	938.270	charged proton
$n^0$	d.u.d=KIRKKIR	$m_k+2[L_2]-2[e^-]+\frac{1}{3}[e^-]-\Delta_s$	939.776+3.0026-1.0410+0.1735-0.041	941.8701	939.554	neutral neutron
$\mu^\pm$	OR* in 1st OR oscillation	$m_L - L_1 - \Delta$ $n[L_s : 98.19-111.05]$	111.04536-(4.9028+ $\Delta$ )	106.143- $\Delta$	105.6584	charged muon
$\tau^\pm$	OR** in 2nd OR oscillation	$L_M - m_L + 2g_s + L_s + L_{ud} + \Delta$	1822.88-111.05+0.9837+52.31+16.01+ $\Delta$ =1712.81+68.32+ $\Delta$	1781.13+ $\Delta$	1776.86	charged tauon
$\pi^0$	u.ubar; d.dbar	$m_{g_{u,d}}-L_{u,d}+e^-+\frac{1}{3}e^- + \Delta$	150.5781-16.014+0.6940+ $\Delta$	135.258+ $\Delta$	134.9776	neutral pion ground state
$\pi^\pm$	u.dbar; ubar.d	$m_{g_{u,d}} - L_{u,d} + L_1 + e^- + \Delta$ $\pi^0 + L_1 - \frac{1}{3}e^- + \Delta$	150.5781-16.014+4.9028+ $\sim e^- \Delta$ 135.258+4.9028-0.1735+ $\Delta$	139.987+ $\Delta$ 139.987+ $\Delta$	139.5702	charged pion
$\lambda^0$	d.u.s	$m_{n^0} + m_{\pi^0} + g_{L2} - L_1 + \Delta$	941.911+135.26+46.100-4.903+ $\Delta$	1118.37+ $\Delta$	1115.683	neutral lambda

The VPE-Means are indicators for average effective quark masses found interactions.

Kernel-K-mixing of the wavefunctions gives  $K(+)$  = 60.214 MeV\* and  $K(-)$  = 31.986 MeV\* and the IROR-Ring-Mixing gives  $(L(+))$  = 6.404 MeV\* and

$(L(-))$  = 3.402 MeV\* for a (L-K-Mean of 1.5010 MeV\*) and a (L-IROR-Mean of 4.9028 MeV\*); the Electropole ( $[e^-]$  = 0.52049 MeV\* and  $3x(0.17350$  MeV\* for  $e^\pm/3$ ) as the effective electron mass and as determined from the electronic radius and the magneto charge in the UFOQR.

The rest masses for the elementary particles can now be constructed, using the basic nucleonic Restmass ( $m_c=9.9247245x10^{-28}$  kg\*= $\sqrt{\Omega g_{\alpha} m_p}$ ) for  $n_p$  as  $1.71175286x10^{-27}$  kg\* or 958.99 MeV\* and setting as the basic maximum

(UP/DOWN-K-mass=mass(KERNEL CORE)= $3x$ mass(KKK)= $3x319.6637$  MeV\*=958.991 MeV\*).

Subtracting the (Ring VPE  $3xL(+)$  =19.215 MeV\*, one gets the basic nucleonic K-state for the atomic nucleus (made from protons and neutrons) in:  $\{m(n^0;p^+) = 939.776$  MeV\*}.

A best approximation for Newton's Gravitational constant 'Big G' hence depends on an accurate determination for the neutron's inertial mass, only fixed as the base nucleon minimum mass at the birth of the universe. A fluctuating Neutron mass would also result in deviations in 'G' independent upon the sensitivity of the measuring equipment. The inducted mass difference in the protonic-and neutronic rest masses, derives from the Higgs-Restmass-Scale and can be stated in a first approximation as the ground state.

A basic nucleon rest mass is  $m_c=\sqrt{\Omega g_{\alpha} m_p} = 9.9247245x10^{-28}$  kg\* or 958.99 MeV\*. (Here  $\Omega$  is a gauge string factor coupling in the fundamental force interactions as:

Cube root( $\Omega$ ): $\Omega$ :Cuberoot( $\Omega$ ): $\Omega$  and for  $\Omega = G-\alpha$ .)

KKK-Kernel mass = Up/Down-HiggsLevel=3x319.66 MeV\* = 958.99 MeV\*, using the Kernel-Ring and Family-Coupling Constants.

Subtracting the Ring-VPE (3L) gives the basic nucleonic K-State as 939.776 MeV\*. This excludes the electronic perturbation of the IR-OR oscillation.

For the Proton, one adds one (K-IR-Transition energy) and subtracts the electron-mass for the dquark level and for the Neutron one doubles this to reflect the up-down-quark differential.

An electron perturbation subtracts one  $2-2/3=4/3$  electron energy as the difference between 2 leptonic rings from the proton's 2 up-quarks and  $2-1/3=5/3$  electron energy from the neutron's singular up-quark to relate the trisected nucleonic quark geometric template. The neutron's down-strange oscillation, enabling its beta decay into a left-handed proton, a left-handed electron and a right-handed antineutrino subtracts  $\Delta_s = g_{L2} - g_{L1} + 2L_{u,d} = 0.041 \text{ MeV}^*$  as a  $d^* = s$  quark differential.

Proton  $m_p = u.d.u = K.KIR.K = (939.776 + 1.5013 - 0.5205 - 0.1735) \text{ MeV}^* = 940.5833 \text{ MeV}^*$  (938.270 MeV) Neutron  $m_n = d.u.d = KIR.K.KIR = (939.776 + 3.0026 - 1.0410 + 0.1735 - 0.041) \text{ MeV}^* = 941.87 \text{ MeV}^*$  (939 MeV).

This is the ground state from the Higgs-Restmass-Induction-Mechanism and reflects the quarkian geometry as being responsible for the inertial mass differential between the two elementary nucleons. All ground state elementary particle masses are computed from the Higgs-Scale and then become subject to various fine structures. Overall, the measured gravitational constant 'G' can be said to be decreasing over time.

The Higgs Boson HB is said of having been measured in the decay of W's, Z's, and Tau Leptons, as well as the bottom- and top-quark systems described in the table and the text addressing K-KIR-KOR transitions. The K means core for kernel and the IR means Inner Ring and the OR mean Outer Ring. The Rings are derivatives from the L-Boson of the HO(32 string class) and the Kernels are the products of the decay of the X-Boson from the same brane source. So, the Tau-decay relates to 'Rings' which are charmed and strange and bottomized and topped, say. They are higher energy manifestations of the basic nucleons of the proton and the neutrons and basic mesons and hyperons.

The energy resonances of the Z-boson (uncharged) represent an 'average' or statistical mean value of the 'Top-Quark' and the Upper-Limit for the Higgs Boson is a similar 'Super-Quark' 'average' and as the weak interaction unification energy.

A postulated energy for the Higgs Boson of so 110 GeV is the Omicron-resonance, is inferred from the table above. The most fundamental way to generate the Higgs Boson as a 'weak interaction' gauge is through the coupling of two equal mass, but oppositely charged W-bosons (of whom the  $Z^0$  is the uncharged counterpart).

The W-mass is a summation of all the other quark-masses as kernel-means from the strangeness upwards to the truth-quark level.

Then doubling the 80.622 GeV\* and 80.424 GeV mass of the weak-interaction gauge boson must represent the basic form of the Higgs Boson and that is 161.244 GeV\* or 160.847 GeV as a function of the electro-weak coupling and related as a 'charged current' weak interaction to a 'neutral current' interaction mediated by the  $Z^0$  boson of energy about 91 GeV\* to sum for a 'Vacuum Expectation Value' of about 252 GeV\*.

Higgs Boson Weakon WNI-Mass  $M_{HBWZ} = \{W^- + W^+ + Z^0\} \text{ GeV}^* = \{80.622 + 80.622 + 91.435\} \text{ GeV}^* = 252.68 \text{ GeV}^*$

$\{(14.11355+46.100)+(1.5010+4.9028)+(150.571+491.8401+1,606.53+5,247.48+17,140.13+55,985.5)+(182,869)+(597.159.0)\}$   
 $= \{60.2136\}+\{6.404\}+\{80,622.05\}+\{182,869\}+\{597,159\} = \{66.6618\}+\{80,622.05\}+\{2 \times 91,434.5\}+\{2 \times 298,580\} = 860,716.7 \text{ MeV}^*$

- Kernel-Inner Ring VPE = 0.04611 GeV\*
- Kernel-Outer Ring VPE = 0.01411 GeV\*
- Pion-(KIR-Quark d)-VPE = 0.1501 GeV\*
- Kaon-(KOR-Quark s=d\*)-VPE = 0.4918 GeV\*
- Charm-(Diquark U=uu)-VPE = 1.60653 GeV\*
- Bottom-(Diquark b=ud)-VPE = 5.24748 GeV\*
- Magic-(Diquark m=us)-VPE = 17,140.13 GeV\*
- Dainty-(Diquark D=dd)-VPE = 55,985.5 GeV\*
- Top-(Diquark t=ds)-VPE = 182,869 GeV\*
- Super-(Diquark S=ss)-VPE = 597,159 GeV\*

Quark q	Diquark Structure qq	Manifesto	Mean-Kernel-Mass GeV*	Mean-Ring-Mass GeV*	Higgs Boson Mass Integration
Kernel-Outer Ring VPE <sub>1</sub>	K↔IR↔OR Kernel-Mesonic-Leptonic	KIR=d KOR=s	K <sub>1</sub> 0.01411355	L <sub>1</sub> 0.0015010	
Kernel-Inner Ring VPE <sub>2</sub>	K↔IR Kernel-Mesonic	K=u	K <sub>2</sub> 0.046100	L <sub>2</sub> 0.0049028	$\frac{1}{2}(K_2-L_2)$ 0.0206
Pion-(KIR-Quark d)	Base KIR Quark	uq, dq	0.1505781	0.016014	$\sum(d)$ =0.1506
Kaon-(KOR-Quark s=d*)	Resonance KOR Quark	sq	0.49184	0.052308	$\sum(d+s)$ =0.6419
Charm-(Diquark U=uu)	Diquark Singlet Active	Uqbar c=Uubar	1.60653	0.17086	$\sum(d+s+U)$ =2.24843
Bottom-(Diquark b=ud)	Diquark Doublet Active	bqbar	5.24748	0.55808	$\sum(d+s+U+b)$ =7.4959
Magic-(Diquark m=us)	Diquark Doublet Suppressed		17.14013	1.82288	$\sum(d+s+U+b+m)$ =24.636
Dainty-(Diquark D=dd)	Diquark Triplet Suppressed		55.9855	5.95425	$\sum(d+s+U+b+m+D)$ =80.622 = M <sub>W</sub>
Top-(Diquark t=ds)	Diquark Triplet Active	tqbar	182.869	19.44825	$\frac{1}{2}\{t\}$ =91.4345 = M <sub>Z</sub>
Super-(Diquark S=ss)	Diquark Triplet Suppressed		597.159	63.52527	$\frac{1}{2}\{S\}$ =298.58 = HVE



$$\Sigma(M_W^+ + M_W^- + M_Z^0) = 2M_{HB}^0 = (80.622 + 80.622 + 91.4345) \text{ GeV}^* = 252.679 \text{ GeV}^*$$

For Universal Electro-Weak Unification:

$$2M_{BH0}/Y^{npresent} = 2M_{BH0}e/c^2 Y^{npresent} = 2.6150 \times 10^{-25} \text{ kg}^* \text{ for } 2\pi R_{HB0} = h/M_{HB0}c \text{ and}$$

$$R_{HB0} = 1.3525 \times 10^{-18} \text{ m}^*$$

Restmass-Photon RMP is quantized in volumar  $2\pi^2 R_{RMP}^3 \cdot f_{ps}^2 |_{constant} = e^*$  for

$$R_{RMP}^0 = 1.41188 \dots \times 10^{-20} \text{ m}^*$$

$$\text{HVE} - 2M_{HB}^0 = (298.58 - 252.679) \text{ GeV}^* = 45.901 \text{ GeV}^*$$

$$\text{HVE} - M_{HB}^0 = (298.58 - 126.340) \text{ GeV}^* = 172.24 \text{ GeV}^* = \text{Top-Quark Mass}$$

Fermi Constant for Electro-Weak WNI Unification for universal alpha =  $60\pi e^2/h$ :

$$F_0(\alpha) = \alpha\pi/\{\sqrt{2} \cdot M_W^2 \cdot (1 - M_W^2/M_Z^2)\} = 1.5338574 \times 10^{-3} \cdot \alpha = 1.12067834 \times 10^{-5} = 1/\{298.72 \text{ GeV}^*\}^2$$

for universal alpha =  $60\pi e^2/h$

Fermi Constant for Electro-Weak WNI Unification for 'running' alpha =  $\alpha'$ :

$$F_0(\alpha') = \alpha'\pi/\{\sqrt{2} \cdot M_W^2 \cdot (1 - M_W^2/M_Z^2)\} = 1.5338574 \times 10^{-3} \cdot \alpha' = 1.166378 \times 10^{-5} = 1/\{292.81 \text{ GeV}^*\}^2$$

for universal alpha =  $60\pi e^2/h$  with  $F_0(\alpha)/F_0(\alpha') = \alpha/\alpha' = 0.9608186 = 1/1.0407792$  for  $\alpha < \alpha'$

$$\text{Fermi-HVE}(\alpha) = 292.81 \text{ GeV}^* = (298.72 - 5.8894 - 0.0206) \text{ GeV}^*$$

$$= \text{Fermi-HVE}(\alpha') - \Sigma(b+s+d) - \frac{1}{2}\{K_2-L_2\} = 292.81 \text{ GeV}^*$$

$$\text{Fermi-HVE}(\alpha') = 298.72 \text{ GeV}^* = (298.58 + 0.14) \text{ GeV}^* = \text{HEV} + 6 \Sigma(b+s+d) + M_\pi$$

$$\text{for base VPE} = u\bar{u} = M_\pi^0 = \Sigma(d) - \delta\{K \leftrightarrow IR \leftrightarrow OR\}$$

$$\{M_\pi = M_\pi^0 + L_2 - \frac{1}{3}m_e = 0.1399945 \text{ GeV}^* \text{ for } M_\pi^0$$

$$= 0.150578 - 0.01604 + (1 + \frac{1}{3})m_e = 0.150578 - 0.016014 + 0.000694 = 0.135258 \text{ GeV}^*\}$$

### Weinberg Angle:

$$\cos\theta_W = M_W/M_Z = 80.622/91.4345 = 0.881746 = g/\sqrt{g^2+g'^2}$$

$$\sin\theta_W = \sqrt{1 - \cos^2\theta_W} = \sqrt{0.222524} = 0.471725 = g'/\sqrt{g^2+g'^2}$$

$$g'/g = \tan\theta_W = \sin\theta_W/\cos\theta_W = 0.53498967 \text{ for } g' < g$$

$$2\{g'/g\alpha'\} = 2\{0.53498967/1.0407792\} = 1.02805604 =$$

$$28.1463^\circ/27.553674^\circ = 1.02150806 + \delta(0.006548)$$

$$\text{for } \theta_W = \arccos\{0.88175\} = 28.1463^\circ = 27.553674^\circ + 0.5926^\circ$$

### Modular ylem mass:

$M|_{mod} = M_{chandra} = M_m = f_{ps}|_{mod}$  from monopolar displacement current:

$$2\pi i/c = 2\pi e f_{ps}/c = 2\pi e/\lambda_{ps} = e/r_{ps} = e \cdot r_{ss} = 2\pi e \lambda_{ss} \text{ for } 2\pi i = [ec] \cdot r_{ss} \text{ as monopolar displacement current}$$

$$2\pi i = 2\pi \lambda_{ss}[ec] = 2\pi e[\lambda_{ss}c] = 2\pi e[f_{ps}\lambda_{ps}\lambda_{ss}] = 2\pi e f_{ps} = 2\pi ec/\lambda_{ps} \Leftrightarrow 2\pi ec/|_{planck}\nu\alpha$$

$$= 2\pi ec^3/e = 2\pi[ec]c^2/e = 2\pi M|_{mod}c^2/e$$

$$i = e f_{ps} = M|_{mod}c^2/e \text{ for } e^2 f_{ps}|_{mod} = M|_{mod}c^2 \text{ for } [h/c^2]f_{ps}|_{mod} = [E/f][m/E]f_{ps}|_{mod} = M|_{mod} = M_m$$

Kernel-VPE-Mixing:

$$K(+)=K++K-=60.21355 \text{ with } K(-)=K+-K-=31.98645$$

$$L(+)=L++L-=6.40128 \text{ with } L(-)=L+-L-=3.4018$$

$K_2 + L_2 = 0.0510 \text{ GeV}^*$  for Kernel-Inner Ring VPE<sub>2</sub> K→IR for Gluonic Kernel to Mesonic Inner Ring

$K_1 + L_1 = 0.0156 \text{ GeV}^*$  for K-Outer Ring VPE<sub>1</sub> (K→)IR→OR for Mesonic Inner Ring to Leptonic Outer Ring

$K_2 - L_2 = 0.0412 \text{ GeV}^*$  for Kernel-Inner Ring VPE<sub>2</sub> K→IR for Gluonic Kernel Base VPE

$K_1 - L_1 = 0.0126 \text{ GeV}^*$  for Kernel-Outer Ring VPE<sub>1</sub> (K→)IR→OR for (Gluonic Kernel)

From Electro-Weak Unification parameters:

$$\{1\text{eV} = 1.0024656 \text{ eV}^*\} \text{ with } T(n_{EW}=4.67 \times 10^{-21}) = 3.40 \times 10^{15} \text{ K}^*$$

$$M_W^\pm = \Sigma_{\text{Kernel-Mean}} = m_{\text{up-down}} + m_{\text{strange}} + m_{\text{charm}} + m_{\text{bottom}} + m_{\text{magic}} + m_{\text{dainty}} =$$

$$0.151 + 0.492 + 1.607 + 5.247 + 17.140 + 55.986 = 80.622 \text{ GeV}^* \text{ or } 80.424 \text{ GeV}$$

$$M_Z^0 = 91.435 \text{ GeV}^* \text{ or } 91.210 \text{ GeV}$$

$$M_{H_X} = 298.580 \text{ GeV}^* \text{ or } 297.846 \text{ GeV}$$

$$\sqrt{2} \cdot \text{Fermi Constant } G = \sqrt{2} \cdot G_F = \sqrt{2} \{ \pi \alpha / (\sqrt{2} \cdot M_W^2 [1 - M_W^2 / M_Z^2]) \} = (1 / \text{Higgs-Vacuum-Expectation HVE})^2$$

$$= 1.5848 \times 10^{-5} \text{ GeV}^{-2} \text{ for HVE} = 251.19 \text{ GeV}^* \text{ or } 250.58 \text{ GeV}$$

As the Charmonium quark state is defined by the coupling of a double-up-diquark  $U=uu$  to an anti-up-quark as  $c=U \cdot u(\text{bar})$  and so as a quark molecule as the quark singlet state of 3 interacting quarks; whilst the diquark doublet of bottom-magic  $\{b=[ud] \cdot u(\text{bar}) \text{ and } m=[us] \cdot u(\text{bar})\}$  and the diquark triplet of dainty-top-super  $\{D=[dd] \cdot U \text{ and } t=[ds] \cdot U \text{ and } S=[ss] \cdot U\}$  form double quarks; the Kernel-Mean of the Charmonium energy level is added to the HVE and the Difference-VPE levels for the K-IR - IR-OR transitions are subtracted for the quark-antiquark coupling.

$$M_W^- + M_W^+ + M_Z^0 = 252.68 \text{ GeV}^* \approx \text{HVE} + m_{\text{charm}} - (m_{K(+)} + m_{K(-)} + m_{L(+)} + m_{L(-)})$$

$$= (251.19 + 1.60653 - [0.0922 + 0.009806]) = 252.69 \text{ GeV}^* \text{ or } 252.07 \text{ GeV}$$

$$m_{\text{charm}} - (m_{K(+)} + m_{K(-)} + m_{L(+)} + m_{L(-)}) = 1.60653 - 0.102 = 1.5045 \approx M_W^- + M_W^+ + M_Z^0 - \text{HEV} = 1.49 \text{ GeV}^*$$

$$\text{HEV} = M_{H_X} - m_D + m_{ud} + 2x m_{\text{charm}} + m_{u,d}$$

$$= 298.580 - 55.986 + 5.24748 + 3.21306 + 0.15058 = 251.205 \text{ GeV}^*$$

≈ HEV in Kernel -Inner Ring mixing

$$\text{HEV} = \text{HB} + \text{anti-HB} = 2x M_{\text{higgs boson}} \text{ for a Higgs Boson mean of: } \frac{1}{2} \{252.68\} = 126.34 \text{ GeV}^* \text{ or } 126.03 \text{ GeV SI.}$$

$$M_{\text{higgs boson}} = 2x \{55.986 + 5.247 + 1.607 + 0.492 + 0.151 + 0.046 + 0.014\} \text{ GeV}^* = 127.09 \text{ GeV}^* = 126.77 \text{ GeV SI}$$

for an upper bound including the base quarks u,d,s and at the Dainty diquark resonance level.

Using the 3 Diquark energy levels U,D and S yield  $M_{\text{higgs boson}} = 2x \{55.986 + 5.247 + 1.607\} \text{ GeV}^* = 125.68 \text{ GeV}^*$  and 125.37 GeV SI. Subtracting the u,d means and the VPE mixing corrections gives:

$$125.68 - (g_{L2} + g_{L1} + g_{u,d} + L2 + L1 + L_{u,d}) = 125.68 - 0.23321 = 125.447 \text{ GeV}^* \text{ or } 125.138 \text{ GeV SI for a measured mass of the Higgs Boson.}$$

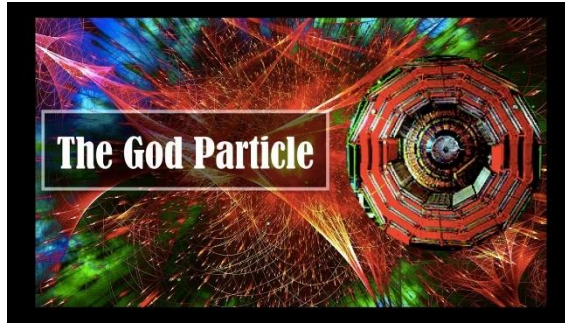

## Standard Model of Elementary Particles

	three generations of matter (fermions)			interactions / force carriers (bosons)	
	I	II	III		
mass	$\approx 2.2 \text{ MeV}/c^2$	$\approx 1.28 \text{ GeV}/c^2$	$\approx 173.1 \text{ GeV}/c^2$	0	$\approx 124.97 \text{ GeV}/c^2$
charge	$\frac{2}{3}$	$\frac{2}{3}$	$\frac{2}{3}$	0	0
spin	$\frac{1}{2}$	$\frac{1}{2}$	$\frac{1}{2}$	1	0
	<b>u</b> up	<b>c</b> charm	<b>t</b> top	<b>g</b> gluon	<b>H</b> higgs
	<b>d</b> down	<b>s</b> strange	<b>b</b> bottom	<b><math>\gamma</math></b> photon	
	<b>e</b> electron	<b><math>\mu</math></b> muon	<b><math>\tau</math></b> tau	<b>Z</b> Z boson	
	<b><math>\nu_e</math></b> electron neutrino	<b><math>\nu_\mu</math></b> muon neutrino	<b><math>\nu_\tau</math></b> tau neutrino	<b>W</b> W boson	

**QUARKS** (purple text on the left)

**LEPTONS** (green text on the left)

**GAUGE BOSONS VECTOR BOSONS** (red text on the right)

**SCALAR BOSONS** (yellow text on the right)

Quantum Relativity describes the creation of the Higgs Boson from even more fundamental templates of the so called 'gauges'. The Higgs Boson is massless but consists of two classical electron rings and a massless doubled neutrino kernel, and then emerges in the magneto charge induction as mass carrying Goldstone gauge boson.

## Higgs Boson resonances found by ATLAS and CMS as diquark conglomerates and Diphotons of CERN as Top-Super diquarks

The 'make-up' of the Higgs Boson can be highlighted in a discovery of a 160 GeV Higgs Boson energy and incorporating the lower energy between 92 GeV and to the upper dainty level at 130 GeV as part of the diquark triplet of the associated topomium energy level.

In particular, as the bottomium doublet minimum is at 5,247.48 MeV\* and the topomium triplet minimum is at 55,985.5 MeV\* in terms of their characteristic Kernel-Means, their doubled sum indicates a particle-decay excess at the recently publicized ~125 GeV energy level in  $2 \times (5.24748 + 55.9855) \text{ GeV}^* = 122.466 \text{ GeV}^*$  (or 122.165 GeV SI).

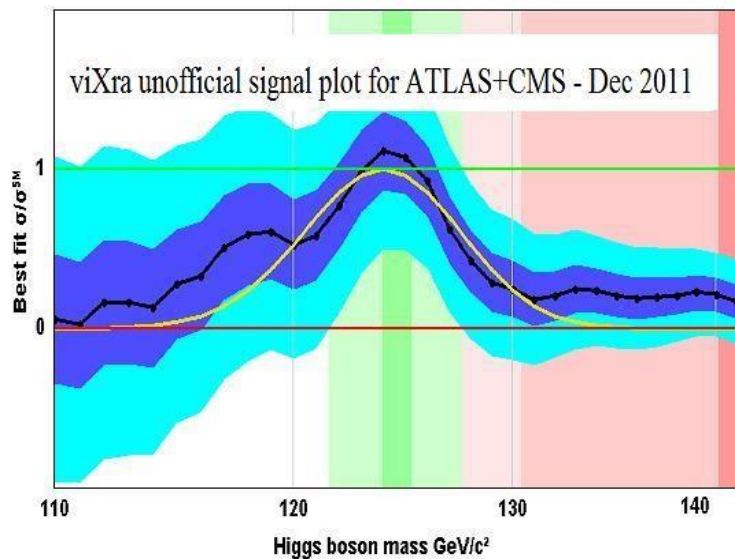

These are the two means from ATLAS {116-130 GeV as 123 GeV} and CMS {115-127 GeV as 121 GeV} respectively. <http://press.web.cern.ch/press/PressReleases/Releases2011/PR25.11E.html>

Then extending the minimum energy levels, like as in the case to calculate the charged weakon gauge field agent energy in the charm and the VPE perturbations as per the table given, specifies the 125 GeV energy level in the Perturbation Integral/Summation:

$2 \times \{55.986 + 5.247 + 1.607 + 0.492 + 0.151 + 0.046 + 0.014\} \text{ GeV}^* = 127.09 \text{ GeV}^*$ , which become about 126.77 GeV SI as an upper bound for this 'Higgs Boson' at the Dainty quark resonance level and using the 3 Diquark energy levels U,D and S yield  $2 \times \{55.986 + 5.247 + 1.607\} \text{ GeV}^* = 125.68 \text{ GeV}^*$  and 125.37 GeV SI.

Some data/discovery about the Higgs Boson aka the 'God-Particle' states, that there seems to be a 'resonance-blip' at an energy of about 160 GeV and as just one of say 5 Higgs Bosons for a 'minimal supersymmetry'. One, the lowest form of the Higgs Boson is said to be about 110 GeV in the Standard Model. There is also a convergence of the HB to an energy level of so 120 GeV from some other models. But according to QR, the Higgs Boson, is that is not a particular particle, but relates to all particles in its 'scalar nature' as a rest mass inducer. It is natural, that an extended form of the Higgs Boson can show a blip at the 160 GeV mark and due to its nature as a 'polarity' neutralizer (a scalar particle has no charge and no spin but can be made up of two opposite electric charges and say two opposing chirality of spin orientations.)

As can be calculated from the table entries below; a (suppressed Top-Super Diquark Resonance is predicted as a  $(ds)U\bar{U}bar(ss)=(ds).u.\bar{u}bar.u.\bar{u}bar.(ss)$  quark complex or diquark molecule averaged at  $182.869+597.159)GeV=780.03$  GeV.

In the diquark triplet  $\{dd; ds; ss\}=\{Dainty; Top; Super\}$  a Super-Superbar resonance at 1.1943 TeV can also be inferred with an 'IR-OR triplet suppressed' Super-Dainty resonance at 653.145 GeV\* and the Top-Dainty resonance at 238.855 GeV\* by the Higgs Boson summation as indicated below.

Supersymmetric partners become unnecessary in the Standard Model, extended into the diquark hierarchies. Next, we interpret this scalar (or sterile) Double-Higgs (anti)neutrino as a majoron and lose the distinction between antineutrino and neutrino eigenstates.

We can only do this in the case of the  $Z^0$  decay pattern, which engage the boson spin of the  $Z^0$  as a superposition of two antineutrinos for the matter case and the superposition of two neutrinos in the antimatter case from first principles.

So, the  $Z^0$  is a Majorana particle, which merges the templates of two antineutrinos say and spin induces the Higgs-Antineutrino. And where does this occur? It occurs at the Mesonic-Inner-Ring Boundary previously determined at the  $2.776 \times 10^{-18}$  meter marker. This marker so specifies the  $Z^0$  Boson energy level explicitly as an upper boundary relative to the displacement scale set for the kernel at the wormhole radius  $r_{ps}=\lambda_{ps}/2\pi$  and the classical electron radius as the limit for the nuclear interaction scale at 3 fermis in:  $R_{compton}\alpha$ .

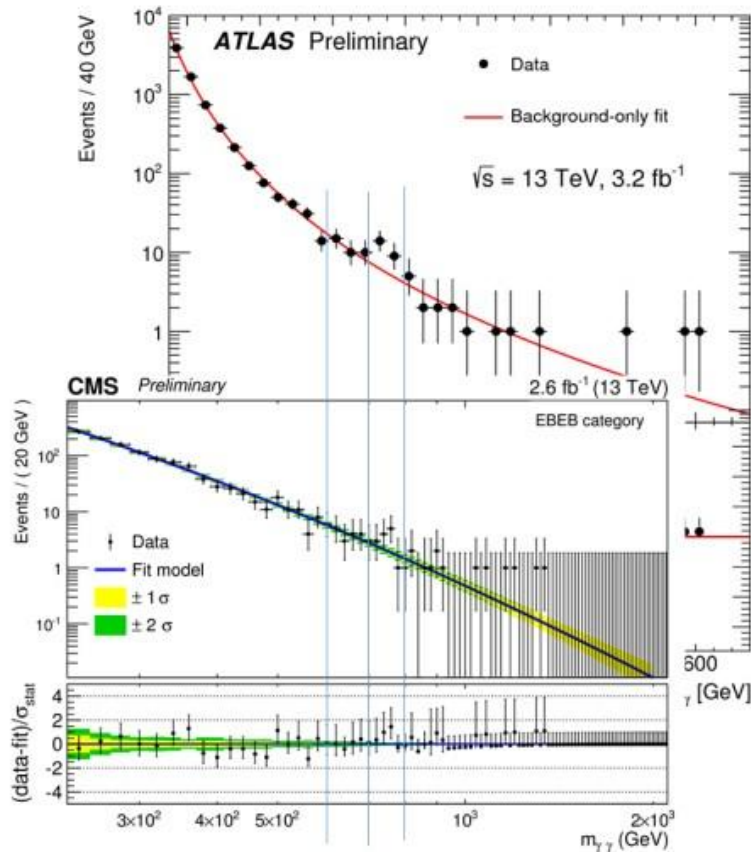

<https://profmattstrassler.com/2015/12/16/is-this-the-beginning-of-the-end-of-the-standard-model/>

Then the particle masses of the standard model in QED and QCD become Compton-Masses, which are Higgs-mass-induced at the Mesonic-Inner-Ring (MIR) marker at  $R_{MIR}=2.777... \times 10^{-18}$  meters. A reformulation of the rotational dynamics associated with the monopolar naturally superconductive current flow and the fractalization of the static Schwarzschild solution follows in a reinterpretation of the Biot-Savart Law.

The Biot-Savart Law:  $B = \mu_0 qv/4\pi r^2 = \mu_0 i/4\pi r = \mu_0 Nef/2r = \mu_0 New/4\pi r$  for angular velocity  $\omega=v/r$  transforms into  $B = \text{constant}(e/c^3)g \times \omega$

in using  $a_{centripetal} = v^2/r = r\omega^2$  for  $g = G_0M/r^2 = (2G_0M/c^2)(c^2/2r^2) = (R_S c^2/2R^2)$  for a Schwarzschild solution  $R_S = 2G_0M/c^2$ .

$B = \text{constant}(e\omega/rc)(v/c)^2 = \mu_0 New/4\pi r$  yields  $\text{constant} = \mu_0 Nc/4\pi = (120\pi N/4\pi) = 30N$  with  $e = m_M/30c$  for  $30N(e\omega/c^3)(G_0M/R^2) = 30N(m_M/30c)\omega(2G_0M/c^2)/(2cR^2) = NmM(\omega/2c^2R)(R_S/R) = \{M\}\omega/2c^2R$ .

Subsequently,  $B = M\omega/2c^2R = Nm_M(R_S/R)\{\omega/2c^2R\}$  to give a manifesting mass  $M$  fine structured in  $M = Nm_M(R_S/R)$  for  $N = 2n$  in the superconductive 'Cooper-Pairings' for a charge count  $q = Ne = 2ne$ . Factor  $2Rc^2$  is then proportional to magneto charge  $e^* = 2Re c^2 = 1/E_{ps}$  with units  $G_0M = M/k_e = 4\pi\epsilon_0 M$

The string-parametric Biot-Savart law then relates the angular momentum of any inertial object of mass  $M$  with angular velocity  $\omega$  in self inducing a magnetic flux intensity given by  $B = M\omega/2Rc^2$  and where the magnetic flux and magnetic field strength relate inversely to a displacement  $R$  from the center of rotation and as a leading term approximation for applicable perturbation series.

The units for magnetic field  $B$  reform from the magneto charge units  $[C^*]$  from Tesla  $[T]^* = [Js/Cm^2]^* = [J/Am^2]^* = [kgm^2s^{-2}]^*/[Cm^2s^{-1}]^* = [kg/s]^*/[C^*] = [kg/s]^*/[m^3/s^2]^* = [M\omega/C^*]^*$

All inertial objects are massless as 'Strominger branes' or extremal boundary Black Hole equivalents and as such obey the static and basic Schwarzschild metric as gravita template for inertia.

This also crystallizes the Sarkar Black Hole boundary as the 100 Mpc limit

$(R_{Sarkar} = (M_0/M_{critical} \cdot R_{Hubble}) = 0.028 \cdot R_{Hubble} \sim 237$  Million lightyears) for the cosmological principle, describing large scale homogeneity and isotropy, in the supercluster scale as the direct 'descendants' of Daughter Black Holes from the Universal Mother Black Hole describing the Hubble Horizon as the de Sitter envelope for the Friedmann cosmology for the oscillatory universe bounded in the Hubble nodes as a standing waveform.

But any mass  $M$  has a Schwarzschild radius  $R_S$  for

$N = (M/m_M)\{R/R_S\} = (M/m_M)\{Rc^2/2G_0M\} = \{Rc^2/2Gm_M\} = \{R/R_M\}$  for a monopolar Schwarzschild radius  $R_M = 2G_0m_M/c^2 = 2G_0(30ec)/c^2 = 60ec/30c^3 = 2e/c^2 = 2L_P \nu \text{Alpha} = 2OL_P$ .

Any mass  $M$  is quantized in the Monopole mass  $m_M = m_P \nu \text{Alpha}$  in its Schwarzschild metric and where the characterizing monopolar Schwarzschild radius represents the minimum metric displacement scale as the Oscillation of the Planck-Length in the form  $2L_P \nu \text{Alpha} \sim L_P/5.85$ .

This relates directly to the manifestation of the magnetopole in the lower dimensions, say in Minkowskian spacetime in the coupling of inertia to Coulombic charges, which is the electro pole and resulting in the creation of the mass-associated electromagnetic fields bounded in the c-invariance.

From the Planck-Length Oscillation or 'L<sub>p</sub>-bounce':  $OL_p = L_p \sqrt{\alpha} = e/c^2$  in the higher (collapsed or enfolded) string dimensions, the electro pole  $e = OL_p \cdot c^2$  maps the magnetopole  $e^* = 2R_e \cdot c^2$  as 'inverse source energy'  $E_{Weyl} = hf_{Weyl}$  and as function of the classical electron radius  $R_e = k_e e^2 / m_e c^2 = R_{Compton} \cdot \alpha = R_{Bohr} \cdot \alpha^2 = 10^{10} \{2\pi r_{ps} / 360\} = \{e^* / 2e\} \cdot OL_p$ .

The resulting reflection-mirror space of the M-Membrane space (in 11D) so manifests the 'higher D' magneto charge 'e\*' as inertial in the monopolar current [ec], that is the electropolar Coulomb charge 'e'. This M-space becomes then mathematically formulated in the gauge symmetry of the algebraic Lie group E<sub>8</sub> and which generates the inertial parameters of the classical Big Bang in the Weylian limits and as the final Planck-String transformation. This descriptor of a string-based cosmology so relates the inherent pentagonal supersymmetry in the cosmogenesis to the definition of the Euler identity in its fine structure  $X+Y = XY = i^2 = -1$ , and a resulting quadratic with roots the Golden Mean and the Golden Ratio of the ancient omniscience of harmonics, inclusive of the five Platonic solids mapping the five superstring classes.

The quantization of mass m so indicates the coupling of the Planck Law in the frequency parameter to the Einstein law in the mass parameter.

The postulated basis of M-Theory utilizes the coupling of two energy-momentum eigenstates in the form of the modular duality between so termed 'vibratory' (high energy and short wavelengths) and 'winding' (low energy and long wavelengths) self-states. The 'vibratory' self-state is denoted in:

$$E_{ps} = E_{\text{primary sourcesink}} = hf_{ps} = m_{ps}c^2 \text{ and the 'winding' and coupled self-state is denoted by:}$$

$$E_{ss} = E_{\text{secondary sinksources}} = hf_{ss} = m_{ss}c^2$$

$$\text{The F-Space Unitary symmetry condition becomes: } f_{ps} \cdot f_{ss} = r_{ps} \cdot r_{ss} = (\lambda_{ps} / 2\pi)(2\pi\lambda_{ss}) = 1$$

$$\text{The coupling constants between the two eigenstates are so: } E_{ps}E_{ss} = h^2 \text{ and } E_{ps}/E_{ss} = f_{ps}^2 = 1/f_{ss}^2$$

The Supermembrane  $E_{ps}E_{ss}$  then denotes the coupled superstrings in their 'vibratory' high energy and 'winded' low energy self-states.

The coupling constant for the vibratory high energy describes a maximized frequency differential over time in  $df/dt|_{\text{max}} = f_{ps}^2$  and the coupling constant for the winded low energy describes its minimized reciprocal in  $df/dt|_{\text{min}} = f_{ss}^2$ .

F-Theory also crystallizes the following string formulations from the  $E_{ps}E_{ss}$  super brane parameters.

$$1/E_{ps} = e^* = 2R_e c^2 = \sqrt{\{4\alpha h c e^2 / 2\pi G_o m_e^2\}} = 2e v \alpha \{m_p / m_e\} = 2k_e e^2 / m_e = \alpha h c / \pi m_e$$

Here  $e^*$  is defined as the inverse of the sourcesink vibratory superstring energy quantum  $E_{ps} = E^*$  and becomes a *New Physical Measurement Unit is the Star Coulomb (C\*)* and as the physical measurement unit for 'Physical Consciousness'.

$R_e$  is the 'classical electron radius' coupling the 'point electron' of Quantum- Electro-Dynamics (QED) to Quantum Field Theory (QFT) and given in the electric potential energy of Coulomb's Law in:

$$m_e c^2 = k_e e^2 / R_e; \text{ and for the electronic rest mass } m_e.$$

Alpha  $\alpha$  is the electromagnetic fine structure coupling constant  $\alpha = 2\pi k_e e^2 / hc$  for the electric charge quantum  $e$ , Planck's constant  $h$  and lightspeed constant  $c$ .

$G_0$  is the Newtonian gravitational constant as applicable in the Planck-Mass  $m_p = \sqrt{hc/2\pi G_0}$ .

As the Star Coulomb unit describes the inverse sourcesink string energy as an elementary energy transformation from the string parametrization into the realm of classical QFT and QED, this transformation allows the reassignment of the Star Coulomb ( $C^*$ ) as the measurement of physical space itself.

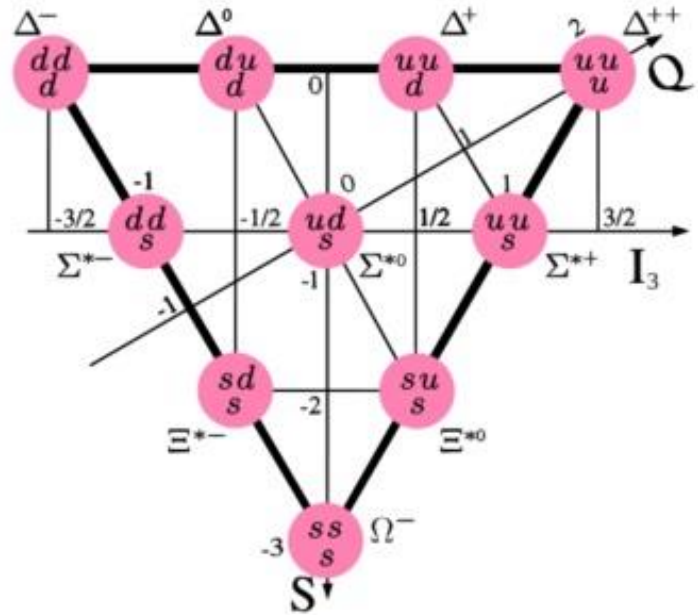
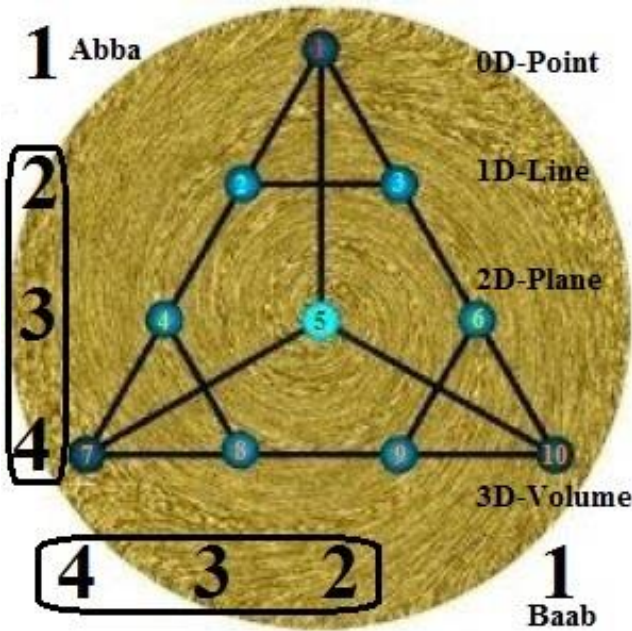

The importance of Kernel-Symmetry so is evidenced in the differentiation of the quarkian permutations and specifying for example the KKIRKOR quark state  $uds$  as a tripartite symmetry of  $u.d.s$  (least stability as SNI-decaying Sigma $^0$  resonance) and  $u.s.d$  (EMI-stable Sigma $^0$  particle) and  $d.u.s$  (WNI-most stable Lambda $^0$  particle).

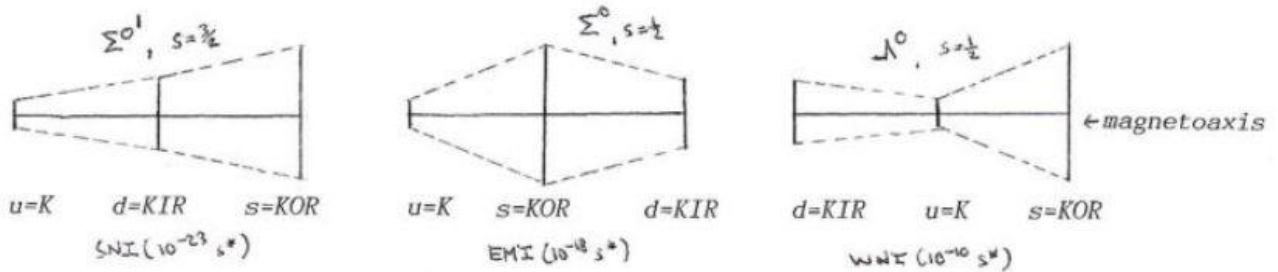

Quantum Geometry in the SU(3) Hyperon Decuplet



March 11<sup>th</sup>, 1979 + 6890 Days = January 20<sup>th</sup>, 1998  
 January 20<sup>th</sup>, 1998 + 6890 Days = December 1<sup>st</sup>, 2016  
 0.53° Transition of Galactic Center Huuh Ku in the angular size of the Sun in 13,780 Days or 37.728 Years as 36 Years + 1 Leap-Year + 265 Gestation Days for a Precessional day count of 9,360,000/360 = 26,000 Kin-Days in 26,000/365.2425 = 71.185 Years per 1 Degree

# Abba's Decoding Key for Baab

The 'chosen ones' 144,000 in prophecy and described through scrolls of antiquity are 2x72,000 as 12x6000 ♂ + 12x6000 ♀ 'selected' from their birthday affiliations with 12 star signs, months of the year, apostles or tribes of Israel. Human Birth implies inherited election as one of the 24 Elders!

11Mar2016 Gestation 265 21 Days Ophiuchus Alpha

21Nov 11:22UCT 1-21Dec2016 Gabriel Persia

Age of Joseph Aquarius 5 Year Transition Interval

22Nov 11:02:34UCT 1-21Dec2021 Michael Grecia 21 Days Arachne Omega

12♂ Elders of the Apocalypse												12♀ Elders of the Apocalypse												
[Mirror Throne]																								
Reuben	Simeon	Levi	Dan	Judah	Gal	Naphtali	Asher	Issachar	Zebulun	Joseph	Benoni	DinaHHaniD	benjamiN	Joseph	zebuluN	issachar	asheR	asphat	gaD	judah	daN	levi	simeoN	reubeN
ⴁ	ⴂ	ⴃ	ⴄ	ⴅ	ⴆ	ⴇ	ⴈ	ⴉ	ⴊ	ⴋ	ⴌ	ⴍ	ⴎ	ⴏ	ⴐ	ⴑ	ⴒ	ⴓ	ⴔ	ⴕ	ⴖ	ⴗ	ⴘ	ⴙ
1	2	3	4	5	6	7	8	9	10	11	12	1	2	3	4	5	6	7	8	9	10	11	12	1

21Dec 2012 21Jun 2013 21Dec 2013 21Jun 2014 21Dec 2014 21Jun 2015 21Dec 2015 21Jun 2016 21Dec 2016 21Jun 2017 21Dec 2017 21Jun 2018 21Dec 2018 21Jun 2019 21Dec 2019 21Jun 2020 21Dec 2020 21Jun 2021 21Dec 2021 21Jun 2022 21Dec 2022 21Jun 2023 21Dec 2023 21Jun 2024 21Dec 2024 21Jun 2025 21Dec 2025

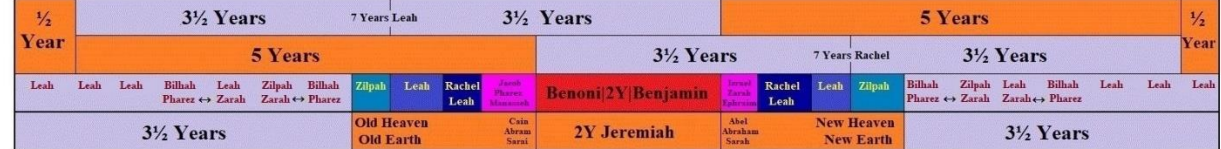

1 Degree of Precession as 71.185 Years, transmitting in 0.38x71.185=13.780 Days [Codes: Genesis.4.1-15; 17.4-16; 25.19-34; 29.16-33; 30.1-24; 32.24-32; 35.9-26; 38; 48; Jer.28.2-3; Mk.13.30-32; Lk.21.31-33; Mat.24.34-36; Rev.4; 21.1] [Gen.6.2 with Acts.1.15]

234,000/360 = 84,240,000 as 230,641,286 Years 365.2425  
 84,240,000/144,000 = 585 = 9x65 = 9x5x13 = 4x13 Baktum  
 13 Years for 4x13 = 52 = 65 - 13 Seasons  
 as 52 Weeks of 7 = 26x7 + 7x26 = 182+182 = 364 = 365 - 1  
 as 1 Year-Time\* - 1 Day-Time\* = 10th 65 Baktum - 25,627 Days  
 25,627 Days as Years = 13,780 + 11,847 = 13,780 Synchronization Transit + 12,000 Jerusalem - 153 Tiberias  
 25,626.8 Precession Days = 71.185 Years x 360 Degrees



228,629 BC + 9 Precession Cycles 234,000x360 Days/Kin = Cycle Reset December 21st, 2012 for Teenager 13 Year Starhuman Graduation 2025

84,240,000/26,000 = 3240 = 1260+720+1260 = 3x1260 + 3x1260  
 144,000 = 2x72,000 = 4x36,000 = 8x18,000 = 40x360 (20x20 Mayan Tum of 360 Kin-Days)  
 13,780 = 13x1060 = 26x540 = 4x1335 + 1260 + 30 + 15 + 30 + 430 + 30 + 15 + 30 + 1260 + 4x1335  
 13,780 = 2x(2300+370) + 1290 + Hour 15 + 490 Daniel + Hour 15 + 1290 + 2x(370+2300)  
 13,780 = 10x1335 + 430 Egypt = 5x1335 + 390 Left Ezekiel Israel + 40 Right Ezekiel Judah + 5x1335

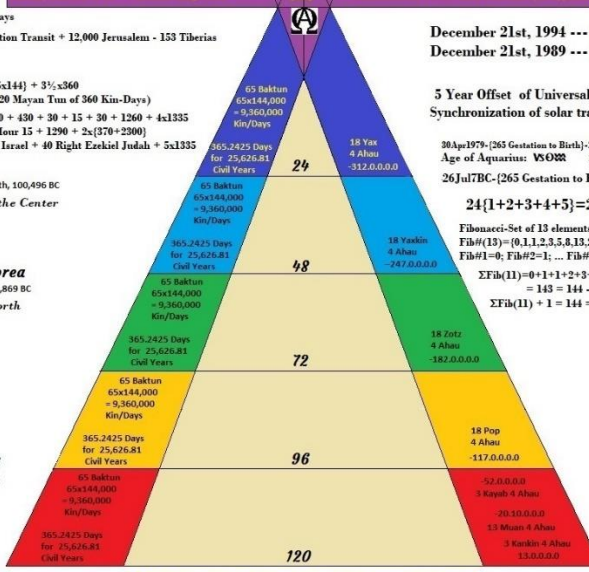

December 21st, 1994 --- December 21st, 2012 --- December 21st, 2030  
 December 21st, 1989 --- December 21st, 2007 --- December 21st, 2025

5 Year Offset of Universal Logos Timeline 18+18=36 = 5+31 Years of Galactic Synchronization of solar transit of angular degree 0.53 for 265+9(1461)+366=13,780

**1st Great Age of Thuban**  
 December 4th, 126,123 BC - September 26th, 100,496 BC  
 Alpha Draconian Serpentina of the Center

**2nd Great Age of Hyperborea**  
 September 26th, 100,496 BC - July 18th, 74,869 BC  
 Arcturian Pachydermi of the North  
 Clockwise Precession Cycle NESW

**3rd Great Age of Lemuria**  
 July 18th, 74,869 BC - May 10th, 49,242 BC  
 Andromedan Felini of the East  
 Clockwise Precession Cycle ESW

**4th Great Age of Zep Tepi**  
 May 10th, 49,242 BC - March 1st, 23,615 BC  
 Pleiadean Cetacini of the South  
 Clockwise Precession Cycle SW

**5th Great Age of Atlantis**  
 March 1st, 23,615 BC - July 27th, 10,802 BC - December 21st, 2012 AD  
 Sirian Cantis of the West  
 Clockwise Precession Cycle W

24 [1+2+3+4+5] = 24x15 = 360  
 Fibonacci-Set of 13 elements = [Fib#(13)]  
 Fib#(13) = {0, 1, 1, 2, 3, 5, 8, 13, 21, 34, 55, 89, 144}  
 Fib#1=0; Fib#2=1; ... Fib#12=89; Fib#13=144  
 ΣFib(11)=0+1+1+2+3+5+8+13+21+34+55 = 143 = 144 - 1  
 ΣFib(11) + 1 = 144 = 12x12 = Fib#13  
 December 21st, 2030  
 Jubilee Year 50  
 March 31st, 2025  
 December 21st, 2024 } 3x65 Baktum Days  
 December 12th, 2024  
 March 31st, 2024  
 - 49 Years = March 31st, 1975

**New Age of Universal Starhumanity**  
 December 21st, 2012 - December 21st, 2025 - .....  
 Omega Alpha of the New Center Logos Universis  
 Mirror Rotation Precession Cycle Completed

180 = 1/2(360) = 13,780 - 13,600	Construction of the New Jerusalem 12,000 = 10,665 + Daniel 1335	1335 + 265 = 1600 Outer Court of the Great City Jerusalem 12,000 + 1600 = 13,600	265 = 1600 - 1335
180	Inner Court of the New Jerusalem	Cleansing of the Sanctuary Daniel 2300 - 2670 - Noah 370	Noah's Covenant 370
180	10,665	1335 Daniel - 2670 - 1335	Gestation 265 to Birth of New Jerusalem
March 31st, 1975	September 27th, 1975	December 8th, 2004	August 4th, 2008
			March 27th, 2011
			March 31st, 2012
			December 21st, 2012

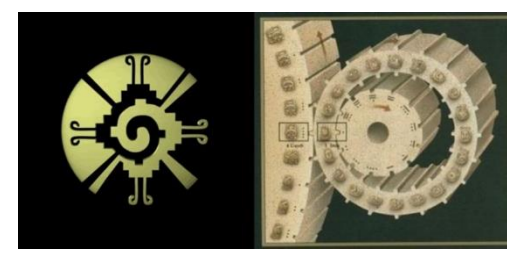

## XIV: The Monopolar Quantum Relativistic Electron

The Monopolar Quantum Relativistic Electron - An extension of the standard model and quantum field theory

Summary | The field around charged particles carries energy, and, if they move, momentum, so such particles have a contribution to their inertia (mass) due to electrodynamics. Classical theory gives  $\infty$  for a point charge - quantum theory does no better - altho several experimental values are known (eg  $\text{Mass}_{\pi^+} - \text{mass}_{\pi^0} = 4.6 \text{ MeV}$ ) no complete satisfactory theory for calculating them is known.

### Summary:

The field around charged particles carries energy, and, if they move momentum. So such particles have a contribution to their inertia (mass) due to electrodynamics. Classical theory gives  $\infty$  for a point charge - quantum theory does no better - although several experimental values are known (eg.  $\text{mass } \pi^+ - \text{mass } \pi^0 = 4.6 \text{ MeV}$ ) no complete satisfactory theory for calculating them is known.

[http://www.feynmanlectures.caltech.edu/II\\_28.html](http://www.feynmanlectures.caltech.edu/II_28.html)

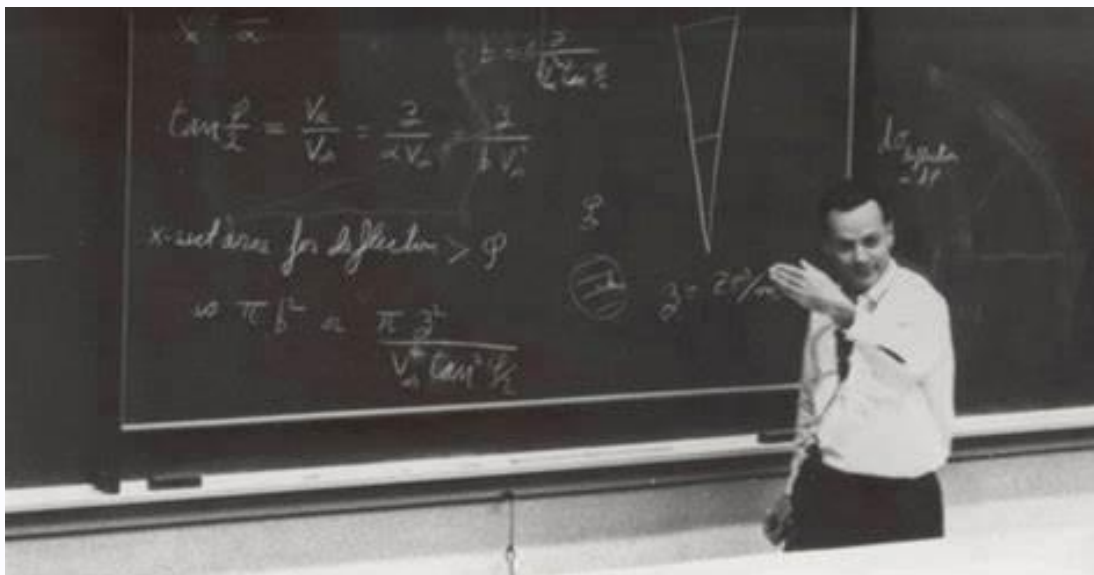



# The theory of everything (so far)

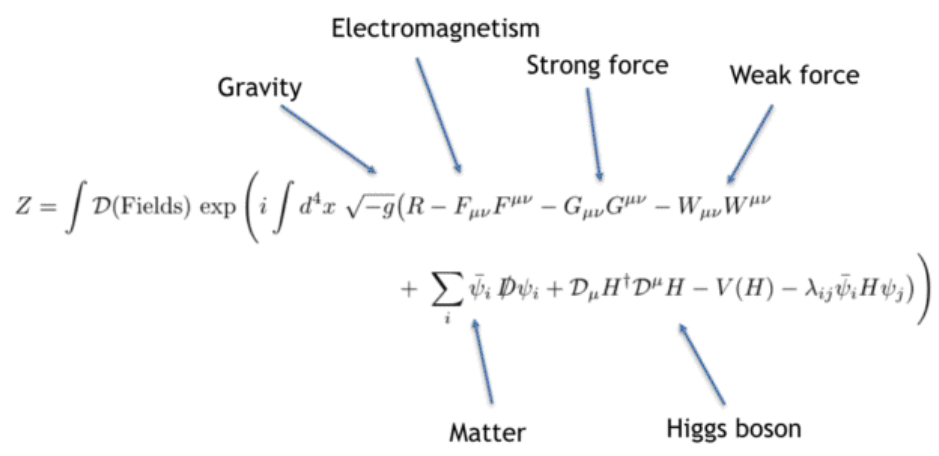

**As David Tong of Cambridge University concludes in his lecture at the Royal Institute :**  
**The three ways for physics to go forwards and advance in correspondence to the experimental results obtained from the LHC:**  
 1. Allow more time for the results of experiments to improve the Standard Model;  
 2. Construct better and more powerful experimental equipment to probe the universe to discover its secrets  
 3. Return to the old equation(s) and search for missing and hidden parts

[https://youtu.be/zNVQfWC\\_evg](https://youtu.be/zNVQfWC_evg)

**A evolution of the definition for the electron:**

Classical - Classical Relativistic - Quantum Mechanical - Electron Quantum Field - Monopolar Classical Quantum Relativistic

**David Tong; Cambridge University; Published on Feb 15, 2017**  
**Quantum Fields: The Real Building Blocks of the Universe**  
**Published on Feb 15, 2017**

According to our best theories of physics, the fundamental building blocks of matter are not particles, but continuous fluid-like substances known as 'quantum fields'. David Tong explains what we know about these fields, and how they fit into our understanding of the Universe.

<https://youtu.be/QUMeKDIgKmk>

1. The Monopolar Quantum Relativistic Electron | Cosmogeneration - Library of Akbar Ra in Alexandria Thuban (cosmosdawn.net)
2. (PDF) The Monopolar Quantum Relativistic Electron: An Extension of the Standard Model & Quantum Field Theory (Part 4 | Anthony P Bermanseder - Academia.edu)
- 3 ([https://www.academia.edu/39753909/T...rk\\_Lepton\\_Unification\\_in\\_XL\\_Boson\\_Class\\_HO\\_32](https://www.academia.edu/39753909/T...rk_Lepton_Unification_in_XL_Boson_Class_HO_32))

Despite the experimental success of the quantum theory and the extension of classical physics in quantum field theory and relativity in special and general application; a synthesis between the classical approach based on Euclidean and Riemann geometries with that of 'modern' theoretical physics based on statistical energy and frequency distributions remains to be a field of active research for the global theoretical and experimental physics community.

In this paper a particular attempt for unification shall be indicated in the proposal of a third kind of relativity in a geometric form of quantum relativity, which utilizes the string modular duality of a higher dimensional energy spectrum based on a physics of wormholes directly related to a cosmogony preceding the cosmologies of the thermodynamic universe from inflaton to instanton.

In this way, the quantum theory of the microcosm of the outer and inner atom becomes subject to conformal transformations to and from the instanton of a quantum big bang or qbb and therefore enabling a description of the macrocosm of general relativity in terms of the modular T-duality of 11-dimensional supermembrane theory and so incorporating quantum gravity as a geometrical effect of energy transformations at the wormhole scale.

Using the linked Feynman lecture at Caltech as a background for the quantum relative approach; this paper shall focus on the way the classical electron with a stipulated electromagnetic mass as a function of its spacial extent exposes the difficulty encountered by quantum field theories to model nature as mathematical point-particles without spacial extent.

In particular, a classical size for the proton can be found in an approximation  $\frac{1}{2}R_e \cdot X = R_p$  for a classical electron radius  $R_e$  and where the factor  $X$  represents the symmetry equilibrium for a  $\beta = (v/c) = f(A)$  velocity ratio distribution for the effective electron rest mass  $m_e$  proportional to the spacial extent of the electron and evolving real solutions for the electron parameters from a quasi-complex space solution for its rest mass  $m_{e0}$ .

Using the  $\beta^2$  distribution in a unitary interval, then bounded in a function of the electromagnetic fine structure constant  $\alpha$ ; the SI-CODATA value for the rest mass of the electron is derived from first inflaton-based principles in the minimum energy Planck-Oscillator  $E_0 = \frac{1}{2}hf_0$  in a conformal mapping of the M-Sigma relation applied to the Black Hole Mass to Galactic Bulge ratio for the alpha bound.

The M-Sigma ratio so can be considered as a scaling proportion between the interior of a Black Hole mapped holographically and radius-conformally as the internal monopolar volume of the electron as a basic premise of the quantum gravitational approach in quantum relativity and in scaling the Schwarzschild solution onto the electron.

A unification condition in a conformal mapping of the alpha fine-structure  $\alpha$  onto  $X$  described by  $X \Leftrightarrow \alpha$  in  $\aleph(\text{Transformation}) = \{\aleph\}^3 : X \rightarrow \alpha\{\#\}^3 \rightarrow \# \rightarrow \#^3 \rightarrow (\#^2)^3 \rightarrow \{(\#^2)^3\}^3$  is applied in this context to indicate the relative interaction strengths of the elementary gauge interactions in proportionality:

$$\text{SNI:EMI:WNI:GI} = \text{SEWG} = \# \cdot \#^3 \cdot \#^{18} \cdot \#^{54}.$$

For the symmetry equilibrium, the electric potential energy and the magnetic action energy are related for an electron velocity of  $v_{eX} = 0.78615138 \cdot c$  and an effective mass energy of  $m_{ef} = \gamma m_e = m_{ecf} = 1.503238892 \times 10^{-30} \text{ kg}^*$ .

This mass-velocity relationship is supplemented by the Compton constant as:  $m_e R_e = \text{Compton constant} = \alpha h / 2\pi c = l_{\text{planck}} \cdot \alpha \cdot m_{\text{planck}} = m_{ec} r_{ec}$ , which proportionalises the quantum relativistic size of the electron with its mass.

The Compton constant ensures Lorentz invariance across all reference frames in cancelling the length contraction with the relativistic mass increase in the product of the proper length  $l_o$  and the proper rest mass  $m_o$  as  $l_o \cdot m_o = l_o \gamma \cdot m_o / \gamma$  in special relativity (SR) in the self-relative reference frame of the monopolar electron.

Subsequently then for an electron speed  $v_{ex}$  and for  $r_{ec} = \alpha h / 2\pi c m_{ec} = 1.71676104 \times 10^{-15} \text{ m}^*$  as a decreased self-relative classical electron radius given by the Compton constant, we calculate a relatively negligible monopolar velocity component in  $(v_{ps}/c)^2 = 1 / \{1 + r_{ec}^4 / ([2\pi\alpha]^2 r_{ps}^4)\} = 1.55261006 \times 10^{-35}$  and characteristic for any substantial velocity for the electron.

The analysis then defines a maximum velocity for the electron with a corresponding quantum relative minimum mass in the form of the electron (anti)neutrino in  $v_e|_{\text{max}} = (1 - 3.282806345 \times 10^{-17}) c$  and  $m(v_e) = m(v_\tau)^2 = 0.00297104794 \text{ eV}^* (0.002963740541 \text{ eV})$  respectively. At this energy then, no coupling between the electron and its anti-neutrino would be possible and the  $W^-$  weakon could not exist.

Subsequently, we shall indicate the effect of the Compton constant and of the quantum relativistic monopolar electron to calculate all of the neutrino masses from first principles in setting  $m_\nu = m_{\text{neutrino}} = m_e \cdot (r_{\text{neutrino}}) / R_e$  and where  $r_\nu$  naturally applies at the limit of the electron's dynamical self-interaction as indicated, that is the electron's quantum relativistic mass approaches that of the instanton of the qbb.

This leads to:  $m_{\nu\text{Electron}} c^2 = m_\nu (v_{\text{Tauon}}^2) c^2 = m_\nu (v_{\text{Muon}}^2 + v_{\text{Higgs}}^2) c^2 = \mu_o \{ \text{Monopole GUT masses } ec \}^2 r_{ps} / 4\pi R_e^2$  and where  $v_{\text{Higgs}}$  is a scalar (anti)neutrino for the mass induction of the (anti)neutrinos in tandem with the mass induction of the scalar Higgs boson in the weak Goldstone interaction.

For the electrostatic electron the  $\beta$  distribution at  $A=1/2$ , the Compton constant gives  $m_{ec} r_{ec} = m_e R_e$  for  $\beta^2 = 0$  and at  $A=1$ , the Compton constant gives  $m_{ec} r_{ec} = 1/2 m_e \cdot 2R_e$  for  $\beta^2 = X$  and as the mean for a unitary interval is  $1/2$ , the electron radius transforms into the protonic radius containing monopolar charge as internal charge distribution in  $R_p = 1/2 X R_e$  and proportional to the effective electron rest mass  $m_e$  proportional to the spacial extent of the electron.

For the proton then, its 'charge distribution' radius becomes averaged as  $R_{\text{proton}} = 0.85838052 \times 10^{-15} \text{ m}^*$  as a reduced classical electron radius and for a speed of the self-interactive or quantum relativistic electron of  $v_{ps} = 1.576125021 \times 10^{-17} c$ .

This monopolar quantum relativistic speed reaches its quantum relativistic  $\{v/c = 1\}$  limit and its maximum QR monopolar speed of  $0.0458 c$  at the instanton boundary and defines a minimum quantum monopolar relativistic speed for the electron at

$v_{pse} = 1.50506548 \times 10^{-18} c$  for its electrostatic potential, where  $U_e = \int \{q^2 / 8\pi\epsilon_o r^2\} dr = q^2 / 8\pi\epsilon_o R_e = 1/2 m_e c^2$  for a classical velocity of  $v_e=0$  in a non-interacting magnetic field  $B=0$ .

$2U_e = m_e c^2$  so implies a halving of the classical electron radius to obtain the electron mass  $m_e = 2U_e / c^2$  and infers an oscillating nature for the electron size to allow a synergy between classical physics and that of quantum mechanics.

The local geometry related to the Compton radius  $h/2\pi m$  is shown to manifest in a linearization of the Weyl wormhole wavelength  $\lambda_{ps} = \lambda_{weyl}$  of the qbb in the photon-mass interaction as a quantum gravitational limit proportional to the mass of the electron in  $r_{weyl} = \lambda_{weyl}/2\pi = 2G_o M_c/c^2 = h/2\pi c m_{ps}$  for a curvature mass  $M_c = hc/4\pi G_o m_{ps}$  conformally transforming  $M_c = 6445.79 \text{ kg}^*$  into  $2.22 \times 10^{-20} \text{ kg}^*$  quantum gravitationally and in a corresponding increase of a sub Planck length linearization of  $r_{cplanck} = 2G_o m_{ps}/c^2 = 5.4860785 \times 10^{-47} \text{ m}^*$  (star units calibrated to the SI mensuration system) to the wormhole scale of the quantum big bang as a quantum geometric curvature effect.

The qbb results from a Planck scale conformal transformation of fundamental parameters in the inflaton, descriptive of energy transformations between five classes of superstrings culminating in the Weyl- $E_{ps}$  wormhole as the final superstring class of heterotic symmetry  $8 \times 8$  to manifest the super membrane  $E_{ps} E_{ss}$  as the wormhole of the 'singularity creation', which is a derivative from a monopolar Planck-Stoney cosmogenesis.

Recircularizing the Compton radius into a Compton wavelength in a {photon - gauge photon} interaction labeled as electromagnetic monopolar radiation or {emr - emmr}, then is shown to define the quantum energy of the vacuum per unit volume as a horn toroidal space-time volumar in  $Vortex-PE = VPE_{ps} = ZPE_{weyl} = 4\pi E_{ps}/\lambda_{ps}^3$  and completing the encompassing energy spectrum in integrating the electric-, magnetic- and monopolar field properties in  $\{ \frac{1}{2} m_{electric} + \frac{1}{2} m_{magnetic} (v/c)^2 + \delta m_{monopolar} \} c^2 = mc^2$ .

The self-interaction of the electron in energy, so crystallizes its monopolar superbrane origin in the addition of a quantum self-relative magnetic energy acting as a 'hidden' electromagnetic monopolar field in the volume of spacetime occupied by the electron as a conformal transformation from the inflaton epoch.

A Planck-Stoney 'bounce' of the electronic charge quantum established the interaction potential between charge and mass energy to break an inherent super-symmetry to transform string class I into string class IIB in modular conformal self-duality of the monopole super-membrane.

Following this initial transformation relating displacement to electric charge in the magneto charge of the monopole; a heterosis between string classes HO(32) and HE(64) enabled the bosonic superstring to bifurcate into fermionic parts in a quark-lepton hierarchy from the HO(32) superstring to the HE(64) superstring of the instanton of the qbb and who is called the Weyl or wormhole boson  $E_{ps}$  in this paper.

We shall also indicate the reason for the measured variation of the fine structure constant by Webb, Carswell and associates; who have measured a variation in alpha dependent on direction.

This variation in alpha is found in the birth of the universe as a 'bounce' or oscillation of the Planck length as a minimum physical displacement and becomes related to the presence of the factor  $\gamma^3$  in the manifestation of relativistic force as the time rate of change of relativistic momentum  $p_{rel}$ .

Furthermore, the mass-charge ratio  $\{e/m_{eo}\}$  relation of the electron implies that a precision measurement in either the rest mass  $m_{oe}$  or the charge quantum  $e$ , would affect this ratio and this paper shall show how the electromagnetic mass distribution of the electron crystallizes an effective mass  $m_e$  from its rest mass resulting in  $m_{eo}\gamma = m_e \gamma^2$  related to the coupling ratio between the electromagnetic (EMI) and the strong nuclear interaction (SNI), both as a function of alpha and for an asymptotic (not running) SNI constant defined from first principles in an interaction transformation between all of the four fundamental interactions.

Since  $\{1-\beta^2\}$  describes the  $\beta^2$  distribution of relativistic velocity in the unitary interval from  $A=0$  to  $A=1$ , setting the quantum relativistic mass ratio  $[m_{oe}/m_e]^2 = \{1-\beta^2\}$  equal to a cosmological M-Sigma ratio conformally transformed from the Planck scale, naturally defines a potential oscillatory upper boundary for any displacement in the unit interval of  $A$ . An increase or decrease in the 'bare' electron mass, here denoted as  $m_{oe}$  can then result in a directional measurement variation due to the fluctuating uncertainty in the position of the electron in the unitary interval mirroring the natural absence or presence of an external magnetic field to either decrease or increase the monopolar part of the electron mass in its partitioning:  $m_{electric} + m_{magnetic} + \delta m_{monopolar} = m_{ec}\{\frac{1}{2} + \frac{1}{2}[v/c]^2\} + \delta_{ps}m_{ec} = m_{ec}$  with  $m_{ec}^2 v\{1 + v^2\gamma^2/c^2\} = m_{ec}^2 \gamma = m_{ec}^2 c^2$  for  $m = m_{ec}$  from the energy-momentum relation  $E^2 = E_0^2 + p^2 c^2$  of classical and quantum theory.

The cosmic or universal value of alpha so remains constant in all cosmological time frames; with the fluctuation found to depend on a constant  $\# = \sqrt[3]{\alpha}$  in a strong interaction constant as a function of alpha.

At the core of physical consciousness lies quantum consciousness; but there it is called self-interaction of a particle or dynamical system in motion relative to its charge distribution.

We shall indicate that it is indeed the charge distribution within such a system and quantized in the fundamental nature of the electron and the proton as the base constituent of atomic hydrogen and so matter; that defines an internal monopolar charge distribution as a quantum geometric formation minimized in the classical size of the electron and the energy scale explored at that displacement scale.

Finally we describe the particles of the Standard Model and including a quantum geometric explanation for the CP violation of the weak interaction, from their genesis in the inflaton and a grand unification symmetry in a transformation of supermembranes and cosmic strings appearing today in a spectrum of cosmic rays:

SEWG-----SEWg-----SEW.G-----SeW.G-----S.EW.G-----S.E.W.G  
 Planck Unification I-----IIB-----HO32-----IIA-----HE64-----Bosonic Unification

## The Electromagnetic Mass Energy and the $[v/c]^2$ Velocity Ratio Distribution

The magnetic energy stored in a magnetic field  $B$  of volume  $V$  and area  $A=R^2$  for a ( $N$ -turn toroidal) current inductor  $N \cdot i = BdR/\mu_0$  for velocity  $v$  and self-induction  $L=NBA/i$  is:

$U_m = \frac{1}{2} Li^2 = \frac{1}{2} (\mu_0 \cdot N^2 R) (BR/\mu_0 N)^2 = \frac{1}{2} B^2 V / \mu_0$  and the Magnetic Energy Density per unit volume is then:

$$U_m/V = \frac{1}{2} B^2 / \mu_0$$

Similarly, the Electric Energy density per unit volume is:

$U_e/V = \frac{1}{2} \epsilon_0 E^2$  say via the Maxwell equations and Gauss' law. So for integrating a spherical surface charge distribution  $dV = 4\pi r^2 \cdot dr$  from  $R_e$  to  $\infty$ :

$$U_e = \int \{q^2 / 8\pi \epsilon_0 r^2\} dr = q^2 / 8\pi \epsilon_0 R_e = \frac{1}{2} m_e c^2$$

$2U_e = m_e c^2$  so implies a halving of the classical electron radius to obtain the electron mass  $m_e = 2U_e/c^2$  and infers an oscillating nature for the electron size to allow a synergy between classical physics and of quantum mechanics.

As Enrico Fermi stated in 1922; changing the rest mass of the electron invokes the ratio  $\beta^2=v^2/c^2$  in an attempt to solve the riddle of electromagnetic mass and the factor of 4/3 differentiating between the electron's relativistic momentum and its relativistic energy.:

"1. It's known that simple electrodynamic considerations<sup>[1]</sup> lead to the value  $(4/3)U/c^2$  for the electromagnetic mass of a spherical electricity-distribution of electrostatic energy U, when c denotes the speed of light. On the other hand, it is known that relativistic considerations for the mass of a system containing the energy U give the value  $U/c^2$ .

Thus, we stand before a contradiction between the two views, whose solution seems not unimportant to me, especially with respect to the great importance of the electromagnetic mass for general physics, as the foundation of the electron theory of matter.

Especially we will prove: The difference between the two values stems from the fact, that in ordinary electrodynamic theory of electromagnetic mass (though not explicitly) a relativistically forbidden concept of rigid bodies is applied. Contrary to that, the relativistically most natural and most appropriate concept of rigid bodies leads to the value  $U/c^2$  for the electromagnetic mass.

We additionally notice, that relativistic dynamics of the electron was studied by M. Born,<sup>[2]</sup> though from the standpoint only partially different from the ordinary electrodynamic one, so that the value  $(4/3)U/c^2$  for the Electron's mass was found of course.

In this paper, Hamilton's principle will serve as a basis, being most useful for the treatment of a problem subjected to very complicated conditions - conditions of a different nature than those considered in ordinary mechanics, because our system must contract in the direction of motion according to relativity theory. However, we notice that although this contraction is of order of magnitude  $v^2/c^2$ , it changes the most important terms of electromagnetic mass, *i.e.*, the rest mass."

The Heisenberg uncertainty principle relating energy with time and displacement with momentum in the expression  $\Delta E \cdot \Delta t = \Delta x \cdot \Delta p \geq h/4\pi$  applied to the quantum mechanical scale of de Broglie wave matter  $\lambda_{dB} = h/mv$  and the Compton mass-photon interaction  $\Delta x = r_{\text{Compton}} = h/2\pi cm$  shows a natural limit for the measurement of position in  $\Delta p = \Delta mv \geq h/4\pi \Delta x = \frac{1}{2}mc$ .

When  $\Delta p$  exceeds  $mc$ , then  $\Delta E$  exceeds  $mc$  in the Energy-Momentum relation  $E^2 = (pc)^2 + (mc^2)^2$  and we can apply this natural limitation on measurement to the position of the electrostatic electron mass in a variable classical electron radius as  $r_{ec} = \alpha h/2\pi cm = \alpha r_{\text{Compton}} = \{\mu_0 e^2 c/2h\} \cdot \{h/2\pi cm_{ec}\} = \mu_0 e^2/4\pi m_{ec}$  and rendering the Compton mass-photon interaction modified in the electromagnetic fine structure constant  $\alpha$  to relate the inverse proportionality between the electron's rest mass to its spacial extent in:

$$m_e R_e = \text{Compton constant} = \alpha h/2\pi c = l_{\text{Planck}} \cdot \alpha \cdot m_{\text{Planck}} = m_{ec} r_{ec} \dots\dots\dots [\text{Eq.XII-1}]$$

The Compton constant ensures Lorentz invariance across all reference frames in cancelling the length contraction with the relativistic mass increase in the product of the proper length  $l_0$  and the proper rest mass  $m_0$  as  $l_0 \cdot m_0 = l_0 \gamma \cdot m_0/\gamma$  in special relativity (SR) in the self-relative reference frame of the monopolar electron.

In particular, a classical size for the proton can be found in an approximation  $\frac{1}{2}R_e \cdot X = R_p$  and where the factor X represents the symmetry equilibrium for a  $B=(v/c)$  velocity ratio distribution for the effective electron rest mass  $m_e$  proportional to the spacial extent of the electron.



For the symmetry equilibrium, the electric potential energy and the magnetic action energy are related for an electron velocity of  $v_e = 0.78615138.c$  and an effective mass energy of  $m_{ef} = \gamma m_e = m_{ecf} = 1.503238892 \times 10^{-30} \text{ kg}^*$  for  $r_{ec} = \alpha h / 2\pi m_{ecf} = 5.150283117 \times 10^{-7} \text{ m}^*$  as a largely increased classical electron radius given by the Compton constant for a negligible monopolar velocity component in  $(v_{ps}/c)^2 = 1 / \{1 + r_{ec}^4 / ([2\pi\alpha]^2 r_{ps}^4)\} = 1.916797918 \times 10^{-69}$  for any substantial velocity for the electron.

For the proton then, its 'charge distribution' radius becomes averaged as  $R_{proton} = 0.85838052 \times 10^{-15} \text{ m}^*$  as a reduced classical electron radius and for a speed for the self-interactive or monopolar quantum relativistic electron of  $2.96026005 \times 10^{-13} c$ . This quantum relativistic speed reaches its  $v/c = 1^-$  limit at the instanton boundary and defines a minimum quantum relativistic speed for the electron at  $v_e = 1.50506548 \times 10^{-18} c$  for its electrostatic potential, where  $U_e = \int \{q^2 / 8\pi\epsilon_0 r^2\} dr = q^2 / 8\pi\epsilon_0 R_e = \frac{1}{2} m_e c^2$  for a classical velocity of  $v_e = 0$  in a non-interacting magnetic field  $B=0$ .

Considering the surface charge distribution of the electron's electric potential to also exhibit a self-interactive term applying to a spacial distribution of the electron mass in its quantum relativistic volume, then this part can be defined as the self-interaction of a purely electromagnetic part of the electron's electrodynamic energy.

Then for a constant charge density in the electron's volume;  $\rho = 3q / (4\pi r^3)$  and  $q = 4\pi\rho r^3 / 3$  with  $dq/dr = 4\pi\rho r^2 dr$

The electrostatic potential for this charge distribution  $V(r) = q / 4\pi\epsilon_0 r$  then contains an energy  $dU = qdq / (4\pi\epsilon_0 r)$  for  $U(r) = \int \{16\pi^2 \rho^2 r^5 / 12\pi\epsilon_0 r\} dr = (4\pi\rho^2 / 3\epsilon_0) \int r^4 dr = \frac{3}{5} \cdot e^2 / 4\pi\epsilon_0 R_e = \frac{3}{5} \cdot \mu_0 e^2 c^2 / 4\pi R_e = \frac{3}{5} \cdot m_e c^2$  for an electron rest mass  $m_e = 2U_e / c^2$  reduced by 40%.

In the linked Feynman lecture; the discrepancy between the electron radius and its electromagnetic mass is found in a factor of  $U(r) = \frac{3}{4} \cdot m_e c^2$  for  $U_e = \mu_0 e^2 c^2 / 6\pi R_e = \frac{1}{2} (1 + \frac{1}{3}) m_e c^2 = \frac{2}{3} m_e c^2$  and here reduced by 33⅓%. Then a question about the cause and origin of the discrepancy in the electrodynamic properties of the electron can be asked. As it seems that the total mass of the electron is somehow distributed between the electric and the magnetic field properties to which should be added a self-interaction effect to account for the differences.

But we can see, that should one use the measured electron mass from the  $R_e$ -definition as the electron's rest mass, that  $m_{magnetic} + m_{electric} = m_e \{ \frac{1}{2} + \frac{1}{2} (v/c)^2 \} < m_e$ , because of the mass-velocity dependency factor  $\beta$  and the group velocities  $v < c$ . To account for the 'missing' mass we simply introduce a 'missing', potential or inherent mass term  $\delta m_e$  and call it the monopolar self-interaction mass of the electron to write:

$m_{electric} + m_{magnetic} + \delta m_{monopolar} = m_{ec} \{ \frac{1}{2} + \frac{1}{2} [v/c]^2 \} + \delta_{ps} m_{ec} = m_{ec}$  with  $m_e c^2 \sqrt{1 + v^2/c^2} = m_e c^2 \gamma = m_{ec} c^2$  for  $m = m_{ec}$  from the energy-momentum relation  $E^2 = E_0^2 + p^2 c^2$  of classical and quantum theory.

The aim is to redefine  $\delta_{ps} = 1/2\gamma^2$  in  $\beta^2$  to relate the mass discrepancy to the monopolar nature of the quantum relativistic electron.

$$\delta_{ps} = \frac{1}{2} \{1 - [v/c]^2\} = \frac{1}{2} \gamma^2 \text{ for } \gamma = 1/\sqrt{1 - [v/c]^2} = 1/\sqrt{1 - \beta^2} \quad [\text{Eq.XII-2}]$$

By the Biot-Savart and Ampere Law:

$B = \mu_0 q \cdot v / 4\pi r^2$  and  $\epsilon_0 = 1/c^2 \mu_0$  for the  $E=cB$  foundation for electrodynamic theory. So for integrating a spherical surface charge distribution  $dV = 4\pi r^2 \cdot dr$  from  $R_e$  to  $\infty$ :

$$U_m = \int \{ \mu_0 q^2 v^2 / 8\pi r^2 \} dr = \mu_0 q^2 v^2 / 8\pi R_e = \frac{1}{2} m_e v^2$$

$$m_{\text{magnetic}} = \mu_0 e^2 [v/c]^2 / 8\pi R_e = m_{ec} \cdot A \beta^2 = \frac{1}{2} m_e \cdot (v/c)^2 \text{ for a constant } A = (\mu_0 e^2 / 8\pi R_e) / m_{ec} = m_e / 2m_{ec} \text{ for } R_e m_e = \mu_0 e^2 / 4\pi = \alpha h / 2\pi c$$

Similarly,  $U_e = \int dU_e = q^2 v^2 / 8\pi \epsilon_0 R_e = k_e q^2 / 2R_e = \frac{1}{2} m_e c^2$  as per definition of the classical electron radius and for the total electron energy  $m_e c^2$  set equal to the electric potential energy.

We term  $m_e$  here the effective electron mass and so differing it from an actual 'bare' rest mass  $m_0$ .

$m_{\text{electric}} = k_e q^2 / 2R_e c^2 = k_e q^2 / e^* = q^2 / 8\pi \epsilon_0 R_e c^2 = U_e / c^2 = \frac{1}{2} m_e$  and consider the electric electron energy to be half the total energy (akin the virial theorem for  $PE=2KE$ , say in the Bohr atom)

$PE = (-) k_e e^2 / R_e = e^2 / 4\pi \epsilon_0 R_e = 2e^2 / 8\pi \epsilon_0 R_e = 2KE$  and where for a single hydrogen electron:

$R_{\text{Bohr}} = h^2 / \pi m_e e^2 \mu_0 c^2 = R_e / \alpha^2 = R_{\text{Compton}} / \alpha = h\alpha / 2\pi m_e c$  for an electromagnetic fine structure constant

$$\alpha = \alpha = e^2 / 2\epsilon_0 h c = \mu_0 c e^2 / 2h$$

$m_{\text{magnetic}} = \mu_0 e^2 [v/c]^2 / 8\pi R_e = m_{\text{electric}} \cdot (v/c)^2 = \frac{1}{2} m_e \cdot (v/c)^2$  and which must be the KE by Einstein's  $c^2 dm = c^2 (m_e - m_0)$

and for the relativistic electron mass  $m = m_0 / \sqrt{1 - \beta^2} = m_0 \gamma$  for  $\beta^2 = (v/c)^2$

So we introduce a quantum relativistic (QR) monopolar rest mass  $m_{ec}$  with a Compton-de Broglie momentum  $m_{ec} \cdot c = h/\lambda_e = hf_e/c^2$  and consider there to be a frequency dependent photonic part in this rest mass and a part, which we have labeled as having an electromagnetic monopolar radiative or emmr origin.

The effective minimum rest mass for the electron in electro stasis in the absence of an external magnetic field in Maxwell's equations and as a function of the Compton constant then also harbours an internal emmr magnetic field as the sought after self-interaction of the electron.

We shall find that the  $\beta^2$  distribution for the electron velocity defines a natural mirror boundary for an actual electron speed at 0, which so enables a complex electron velocity to decrease towards this complex boundary from a complex electron space and to then increase from this boundary as a real observed part.

We shall find that the classical electrostatic electron in the absence of its monopolar component can be considered to move with a speed of 0.177379525 c through an electrostatic potential of 8.25368811 keV\*.

It is then a monopolar or self-interaction of the electron which effectively doubles its rest mass as a magnetic field applied internally and as a charge distribution for a quantum geometric electron and naturally contains the classical factor of (4/3) as a mean value in the  $\beta^2$  distribution.

The volume occupied by the monopolar magnetic charge distribution relates to quantum chromodynamics and its gluon-colour magnetopolar charges in representing quantized higher dimensional spacetime which can be considered as 'collapsed' in its nature as a 7-dimensional Calabi-Yau manifold, but manifesting as a Riemann 3-sphere or 2-Torus (horn-toroidal) volumar quantizing 11-dimensional spacetime into Weylian wormholes in a mirror 12-dimensional Vafa spacetime.

This spacetime then compactifies the higher dimensional spacetime as a 3-dimensional surface, where a 11-dimensional surface manifold manifests in 3-D spacetime through open ended strings or Dirichlet branes attached in modular string dualities to a hyperbolic open de Sitter (dS) spacetime, but is in mirror duality from a closed spheroidal Anti de Sitter spacetime (AdS) to cancel the curved spacetimes in the Vortex-Potential-Energy or Zero-Point-Energy (ZPE) per unit volume or wormhole VPE of the Weylian spacetime quanta defined for a monopolar group velocity  $v_{ps}$  and the Compton parameters in:

$$\text{Vortex-PE/V} = \text{VPE}_{E_{ps}} = \text{ZPE}_{\text{weyl}} = 4\pi E_{ps}/\lambda_{ps}^3 = 2\alpha^2 E_{ps} \{ [c/v_{ps}]^2 - 1 \} / r_{ec}^3 = E_{ps}/V_{ps} \dots\dots\dots [\text{Eq.XII-3}]$$

$$V_{ps} = (2\pi r_{ps}) \cdot (\pi r_{ps}^2) = 2\pi^2 r_{ps}^3$$

### The Extension of Newton's Law in Relativistic Momentum and Energy and the Magnetopolar Self-Interaction of the Electron

Newton's law for force is mass times acceleration  $F = ma$  can be written in relativistic form as the change of the linear momentum over time and with an associated 'hidden' form of angular momentum change and acceleration in the change of rest mass as photonic energy and mass equivalent over time itself:

$$\begin{aligned} dp_{rel}/dt &= d(m_o \gamma v)/dt = m_o d(\gamma v)/dt + \gamma v d(m_o)/dt = \\ m_o d(\gamma v)/dt + \{ \gamma v h/c^2 \} df/dt &= m_o \gamma^3 \cdot dv/dt + \{ \gamma v h/c^2 \} df/dt = F_a + F_\alpha \text{ for } \gamma = 1/\sqrt{1 - [v/c]^2} \dots\dots\dots [\text{Eq.XII-4}] \end{aligned}$$

The product  $m_e \cdot R_e = \text{Compton constant} = h\alpha/2\pi c = \alpha \cdot l_{\text{planck}} \cdot m_{\text{planck}}$

A changing electron size  $r_e$  changes the electron rest mass  $m_o$  in proportionality  $r_e \propto 1/m_o$  and where  $m_o = m_{ec} = m_e$  as the electromagnetic relativistic quantum mass for  $r_e = R_e = R_{\text{compton}}/\alpha$ .

The boundary relativistic electron mass so becomes the Compton wormhole mass of the Quantum Big Bang  $\alpha \cdot m_{ps} = \alpha \cdot hf_{ps}/c^2$

The classical electron's acceleration  $a = F_a/m$  from its relativistic force  $F_{rel} = d(p_{rel})/dt$  for a constant rest mass  $m_o$  is then supplemented by a quantum acceleration  $\alpha$  from its quantum mechanical Compton mass  $m_{\text{compton}} = m_{ec} = h\alpha/2\pi cr_e$  and where the classical rest mass  $m_o$  changes as  $m_{ec}c^2 = (hvr_e/c^2) \cdot \gamma \cdot (df/dt)$ .

The frequency differential over time is maximized in  $\{df/dt\}|_{\text{max}} = \{(f_{ps} - f_{ss})/f_{ss}\} = f_{ps}^2 - 1$  as the maximum entropy frequency permutation eigenstate  $f_{ps}^2 = 9 \times 10^{60}$  for its minimum state  $f_{ss}^2 = 1/f_{ps}^2$  by modular string T-duality  $f_{ps} \cdot f_{ss} = 1$  of super-membrane  $E_{ps}E_{ss}$  and wormhole frequency  $f_{\text{weyl}} = f_{ps}$ .

In units of angular acceleration,  $df/dt$  so relates Planck's constant  $h$  and the Planck action in  $dE/dt = hdf/dt$  and the Heisenberg Uncertainty principle in  $dE \cdot dt = h \cdot df \cdot dt$  in this string T-duality of the frequency self-states  $f_{ps}|_{\text{max}}$  and  $f_{ss}|_{\text{min}}$  and for the mass-eigen frequency quantum  $f_{ss} = m_{ss}c^2/h$  by brane coupling constants  $E_{ps} \cdot E_{ss} = h^2$  and  $E_{ps}/E_{ss} = f_{ps}^2$ .

- (1) Energy  $E = hf = mc^2$  (The Combined Planck-Einstein Law)
- (2)  $E = hf$  iff  $m = 0$  (The Planck Quantum Law  $E=hf$  for light speed invariance  $c=\lambda f$ )
- (3)  $E = mc^2$  iff  $f = f_o = f_{ss}$  (The Einstein Law  $E = mc^2$  for the light speed upper limit)

(1) Whenever there is mass ( $M = M_{\text{inertial}} = M_{\text{gravitational}}$ ) occupying space; this mass can be assigned either as a photonic mass {by the Energy-Momentum relation of Special Relativity:  $E^2 = E_o^2 + (pc)^2$ } and by the photonic momentum  $p = h/\lambda = hf/c$  or as a 'rest mass'  $m_o = m \cdot \sqrt{1 - (v/c)^2}$  for a 'rest energy'  $E_o = m_o c^2$ .

The 'total' energy for the occupied space so contains a 'variable' mass in the 'combined' law; but allows particularisation for electromagnetic radiation (always moving at the Maxwell light speed constant  $c$  in Planck's Law and for the 'Newtonian' mass  $M$  in the Einstein Law.

(2) If  $M=0$ , then the Einstein Law is suppressed in favour of the Planck Law and the space contained energy  $E$  is photonic-electromagnetic, always dynamically described by the constancy of light speed  $c$ .

(3) If  $M>0$ , then there exists a mass-eigen frequency  $f_{ss} = f_o = E_{ss}/h = m_{ss}c^2/h$ , which quantizes all mass agglomerations  $m = \Sigma m_{ss}$  in the mass quantum  $m_{ss} = E_{ss}/c^2$ .

Letting  $r_{ec}$  be the oscillating classical electron radius  $r_{ec}$  from its maximum value  $R_e = \mu_o e^2 / 4\pi m_e = \alpha h / 2\pi c m_e$  to its minimum qbb value  $r_{ps} = \lambda_{ps} / 2\pi$  from the de Broglie wave matter wavelength  $\lambda_e = h/m_e c = c/f_e = hc/E_e = hc/m_e c^2$ ; the electron's energy for its quantum mechanical self-interaction part assigns the photon - mass interaction in the Compton constant in its linearized nature of the QR electron and can be stated as:

$h \Sigma f$  frequency energy states  $= hf_e = m_{ec} c^2 = (h v r_{ec} / c^2) \cdot \gamma \cdot (df/dt) = \{v\gamma\} \{r_{ec} \cdot hf_{ps}^2 / c^2\} = \{v\gamma\} \{hr_{ec} / \lambda_{ps}^2\}$  for the maximum frequency summation at  $r_{ec} = r_{ps}$

for  $v/\sqrt{1 - [v/c]^2} = m_{ec} c^2 \lambda_{ps}^2 / h r_{ec} = \alpha c \lambda_{ps}^2 / 2\pi r_{ec}^2$  using  $m_{ec} r_{ec} = \text{constant} = \alpha h / 2\pi c = m_e R_e$  and  $v^2 / \{1 - [v/c]^2\} = \{\alpha c \lambda_{ps}^2 / 2\pi r_{ec}^2\}^2 = \emptyset^2$  solving for  $v^2 \{1 + \emptyset^2 / c^2\} = \emptyset^2$  with  $(v/c)^2 = \emptyset^2 / (c^2 + \emptyset^2) = 1 / \{1 + [c/\emptyset]^2\}$

The quantum relativistic mechanical electron's velocity distribution for a variable classical electron radius  $R_e$  in the proportional Compton rest mass  $m_{ec}$  and  $r_{ec}$  generalised in the wave matter constancy of de Broglie for the quantum relativistic part of rest mass  $m_o = hf/c^2$  and a purely self-interacting electromagnetic monopolar part as electromagnetic monopolar radiation (emmr) so is:

"Juju's Electron Equation 31 | 31:" applied for the maximum integrated quantum energy state:

$$\{m_{\text{electric}} + m_{\text{magnetic}} + m_{\text{emmr}}\} c^2 = E_{\text{weyl}} = hf_{\text{weyl}} = E_{\text{qbb}} = m_{ps} c^2 = 1/e^*$$

$$\{v_{ps}/c\}^2 = 1 / \{1 + 4\pi^2 r_{ec}^4 / \alpha^2 \lambda_{ps}^4\} = 1 / \{1 + r_{ec}^4 / 4\pi^2 \alpha^2 r_{ps}^4\} \dots \dots \dots [\text{Eq.XII-5}]$$

$$\delta_{ps} = \frac{1}{2} \{1 - [v/c]^2\} = 1/2 \gamma^2 \text{ for } \gamma = 1/\sqrt{1 - [v/c]^2} = 1/\sqrt{1 - \beta^2}$$

This sets the proportionality between monopolar emmr and electromagnetic emr in the constancy of light speed  $c$ :

$v^2 / (1 - 2\delta_{ps}) = c^2 = v_{ps}^2 / \{1 + r_{ec}^4 / 4\pi^2 \alpha^2 r_{ps}^4\}$  for the monopolar  $\delta_{ps}$  and letting  $v_{ps} = xc$  as a fractional monopolar velocity colinear with  $v$ :

For  $\delta_{ps} \rightarrow \frac{1}{2}^+$  as  $v \rightarrow 0$ ,  $\frac{1}{2}$  of the electron's mass will be monopolar in the internal magnetic field in lieu of the absence of an external magnetic field  $B=0$ , with the remaining half being the energy of the electro stasis.

For  $v = \frac{1}{2} c$ ;  $v_{ps} = 2.006753867 \times 10^{-18} c$  and  $r_{ec} = 0.866025403 R_e$  for  $\delta_{ps} = \frac{1}{2}\{1 - 0.25\} = 0.375$   
 For  $v = 0.651899075 c$ ;  $v_{ps} = 3.035381866 \times 10^{-18} c$  and  $r_{ec} = 0.758305739 R_e$  for  $\delta_{ps} = \frac{1}{2}\{1 - 0.315985704\}$   
 $= 0.34200715$

For  $\delta_{ps} \rightarrow 0^+$  as  $v \rightarrow c^-$ ,  $\frac{1}{2}$  of the electron's mass will be magnetic in the external magnetic field B supplementing the remaining half of the electro stasis with a decreasing monopolar component  $\delta_{ps}$  as a function of the monopolar velocity of the electron  $v_{ps}$ .

$$\delta_{ps} = \frac{1}{2}\{1 - [v/v_{ps}]^2\{4\pi^2\alpha^2 r_{ps}^4 / (4\pi^2\alpha^2 r_{ps}^4 + r_{ec}^4)\}\} = \frac{1}{2}\{1 - [v/v_{ps}]^2\{1 / (1 + [r_{ec}/r_{ps}]^4 / 4\pi^2\alpha^2)\}\} \dots\dots\dots[\text{Eq.XII-6}]$$

Then the upper limit for  $r_{ec} = r_{ps}$  and the qbb wormhole boundary is:  
 $\delta_{ps} = \frac{1}{2}\{1 - [c/v_{ps}|_{max}]^2(4\pi^2\alpha^2)/(1+4\pi^2\alpha^2)\} = \frac{1}{2}\{1 - 1\} = 0^+$  for  $v_{ps}|_{max} = (4\pi^2\alpha^2 c^2)/(1+4\pi^2\alpha^2)$  showing that as  $[v/c] \rightarrow 1^-$ ;  $\delta_{ps} \rightarrow 0$  for  $\frac{1}{2}$  of the electron's mass being from the electric field and the other half being from the external magnetic field for increasing relativistic velocity v increasing the monopolar part in  $v_{ps}$  to its maximum at the wormhole qbb scale.

$v_{ps}|_{max} = xc = 2\pi\alpha c / \sqrt{4\pi^2\alpha^2 + 1} = 0.045798805 c$  as the maximized monopolar magnetic speed for the electron and decreasing to its minimum speed  
 $v_{ps}|_{min} = c / \sqrt{1 + 4\pi^2(10^{10}/360)^4 / \alpha^2} c = 1.50506540 \times 10^{-18} c$  for the classical electron radius scale given by  $R_e$  and the internal velocity of the electron in electro stasis.

The lower limit for  $r_{ec} = R_e = 10^{10}\lambda_{ps}/360$  (from the Planck-Stoney-QR Unification) becomes:  
 $\delta_{ps} = \frac{1}{2}\{1 - [v/v_{ps}|_{min}]^2(4\pi^2\alpha^2)/(4\pi^2\alpha^2 + [2\pi \cdot 10^{10}/360]^4)\} = \frac{1}{2}\{1 - [v/v_{ps}|_{min}]^2(1/(1 + 4\pi^2 \cdot 10^{40}/\alpha^2 \cdot 360^4))\}$   
 $= \frac{1}{2} - \frac{1}{2}[v]^2(2.265221852 \times 10^{-36})/(4.5151962 \times 10^{-10}) = \frac{1}{2} - (2.508442326 \times 10^{-27})v^2$ , showing that as  $[v] \rightarrow 0^+$ ;  
 $\delta_{ps} \rightarrow \frac{1}{2}$  for  $\frac{1}{2}$  of the electron's mass being monopolar.

The wave nature of the electron changes the Compton radius to its Compton wavelength however and the derivation of [Eq.5] results in a recircularization of parameters to give a statistical root-mean-square velocity for the QR electron.

$$(h\nu\lambda_{ps}/c^2) \cdot \gamma \cdot (df/dt) = h\nu\lambda_{ps} \cdot f_{ps}^2 \cdot \gamma/c^2 = hf_{ps} = m_{ps}c^2$$

$(v/v(1-[v/c]^2)) = c$  and  $v^2/\{1-[v/c]^2\} = c^2$  solving for  $v^2 = c^2 - v^2$  and  $v^2 = \frac{1}{2}c^2$  for an averaged Compton emr-emm speed of

$$v_{\lambda c} = c/\sqrt{2} \dots\dots\dots[\text{Eq.XII-7}]$$

This formulation sets an upper and lower bound for  $v_{electron}$  in the electron radius in the interval:  
 $\langle R_e|_{max} \dots\dots R_{ec}|_{min} = \lambda_{ps}/2\pi = r_{ps} = r_{Weyl} = r_{wormhole} = r_{qbb} \rangle$

The speed of the quantum mechanical electron of mass  $m_{ec} = \alpha m_{ps} \text{ kg}^*$ , so is maximized in its minimum radius of the wormhole as  $0.045799 c$  or  $13,739,643.01 \text{ (m/s)}^*$  and limits the classical relativistic electron speed in:

$$m_{ec}/v\{1-(v_{ec}/c)^2\} = \alpha m_{ps} = 1.621502875 \times 10^{-22} \text{ kg}^* \text{ for } \{v_{ec}/c\}^2 = 1 - \{m_e/\alpha m_{ps}\}^2$$

$$v_e|_{\max} = \sqrt{1 - (5.72957797 \times 10^{-9})^2} c = \sqrt{1 - 3.28280637 \times 10^{-17}} c \sim \{1 - 1.64140319 \times 10^{-17}\} c = c$$

and as the self-energy  $E_{ec} = m_{ec}c^2 = \alpha m_{ps}c^2 = \alpha E_{ps} = \alpha/e^* J^*$  for the Weyl electron of the quantum big bang (qbb) or instanton following the inflaton of the string epoch.

This energy of self-interaction represents the original Zero-Point or VPE energy of the matrix of spacetime in the minimum Planck oscillator  $|\frac{1}{2}E_o| = |h/4\pi| = \frac{1}{2}E_{\text{planck}}$  which manifests the quantization for the parameters describing dynamical interaction within it.

As such a VPE-Volumar brane, the conformal transformation of the Planck oscillator into the Weyl oscillator can be used to define the concept of a 'physical consciousness awareness quantum'  $\alpha\omega = df/dt$  in the maximized frequency entropy state in a brane volumar and as per [Eq.XII-3].

Here a 4-dimensional Riemann sphere with volume  $V_4(r) = \frac{1}{2}\pi^2 r^4$  manifests as a 3-dimensional surface:  $dV_4/dr = 2\pi^2 r^3$  and so as the encompassing 'mother black hole' solution for the inner horizon of an open de Sitter holographic cosmology bounded by that inner black hole surface as a one-sided 11-dimensional hyper-surface, whose outside uses the mirror modular duality of string physics to define the outer horizon as a Möbian connected topology of closed Anti de Sitter space-time as a quasi-12th dimension, which can be labeled as a Vafa's 'father white hole', quantum entangling the inner- and outer horizons of the Witten manifold mirror in the membrane modular duality.

This allows a number of predictions for particular energy levels to be made.

For the maximized volumar brane at the Weyl energy and for the maximized frequency permutation state.

$V_{\text{brane}} \cdot (df/dt)|_{\max} = 2\pi^2 R_{\text{rmp}}^3 \cdot f_{ps}^2 = e^* = 1/E_{ps} = 2R_e c^2$  in a Restmass photonic or 'dark matter' radius

$R_{\text{rmp}} = \sqrt[3]{\{e^*/2\pi^2 f_{ps}^2\}} = 1.411884763 \times 10^{-20} \text{ m}^*$  for the nuclear electron at

$m_{\text{fermi}} = h/2\pi c R_{\text{rmp}} = 2.50500365 \times 10^{-23} \text{ kg}^*$  or  $14.034015 \text{ TeV}^*$ . This is near the maximum energy potential of the Large Hadron Collider or LHC in Geneva, Switzerland and a form of the 'dark matter' particle should make an appearance at 14 Tev.

For the Compton electron  $e^*/\alpha = 2R_e c^2/\alpha = 2R_{\text{compton}} c^2$ ;  $R_{\text{rmp}} = \sqrt[3]{\{e^*/2\alpha\pi^2 f_{ps}^2\}} = 7.279292496 \times 10^{-20} \text{ m}^*$  for the Compton electron at an energy of  $m_{\text{compton}} = h/2\pi c R_{\text{rmp}} = 4.85868164 \times 10^{-24} \text{ kg}^*$  or  $2.722024 \text{ TeV}^*$

For the Bohr electron  $e^*/\alpha^2 = 2R_e c^2/\alpha^2 = 2R_{\text{bohr}} c^2$ ;  $R_{\text{rmp}} = \sqrt[3]{\{e^*/2\alpha^2\pi^2 f_{ps}^2\}} = 3.75300456 \times 10^{-19} \text{ m}^*$  for the atomic Bohr electron at an energy of  $m_{\text{compton}} = h/2\pi c R_{\text{rmp}} = 9.4238534 \times 10^{-25} \text{ kg}^*$  or  $527.9613 \text{ GeV}^*$

The classical electromagnetic rest-mass  $m_{\text{emr}} = m_e$  becomes quantum mechanical in the string-brane sourcesink energy  $E^*$ -Gauge photon quantum of the Quantum Big Bang Weylian wormhole.

$$E^* = E_{ps} = hf_{ps} = hc/\lambda_{ps} = m_{ps}c^2 = (m_e/2e) \cdot \sqrt{[2\pi G_o/\alpha hc]} = \{m_e/m_{\text{planck}}\}/\{2eV\alpha\} = 1/2R_e c^2 = 1/e^*$$

Monopolar charge quantum  $e^*/c^2 = 2R_e \Leftarrow$  supermembrane displacement transformation  $\Rightarrow \sqrt{\alpha} \cdot l_{\text{planck}} = e/c^2$  as electropolar charge quantum

$$\begin{aligned} m_e &= 2eV\alpha \cdot m_{\text{planck}}/2R_e c^2 = l_{\text{planck}} \sqrt{\alpha} \cdot \sqrt{\alpha} \cdot m_{\text{planck}}/R_e = \alpha \cdot l_{\text{planck}} \cdot m_{\text{planck}}/R_e \\ &= \{e/c^2\} \sqrt{[2\pi ke^2/hc]} \sqrt{[hc/2\pi G_o]}/R_e = \sqrt{[G_o h/2\pi c^3]} \sqrt{[2\pi ke^2/hc]} \sqrt{[hc/2\pi G_o]}/R_e = \{h/2\pi c\} \sqrt{[2\pi ke^2/hc]}/R_e \\ &= \{ke^2/c^2\}/R_e = \{\mu_o e^2\}/4\pi R_e \end{aligned}$$

The product  $m_e \cdot R_e = \text{Compton constant} = h\alpha/2\pi c = \alpha \cdot l_{\text{planck}} \cdot m_{\text{planck}}$

A changing electron size  $r_e$  changes the electron Restmass  $m_o$  in proportionality  $r_e \propto 1/m_o$  and where  $m_o = m_e$  for  $r_e = R_e = R_{\text{Compton}}/\alpha = R_{\text{Bohr}}/\alpha^2$

The boundary relativistic electron mass so becomes the Compton wormhole mass of the Quantum Big Bang  $\alpha \cdot m_{ps} = \alpha \cdot hf_{ps}/c^2$

For the wormhole limit  $r_e = r_{ps} = \lambda_{ps}/2\pi = R_e |_{\text{minimum}}$  in unified string Planck-Stoney units

$$m_e = \alpha m_{ps} = \alpha hf_{ps}/c^2 = \alpha h/c\lambda_{ps} = \alpha/e \cdot c^2 = \alpha/2R_e c^4 = \alpha/2\pi c r_{ps} = \{60\pi h e^2/2\pi h c r_{ps}\} = 30e^2/c r_{ps}$$

$$= 1.62150288 \times 10^{-22} \text{ kg}^* = m_e \gamma = m_e/\sqrt{1 - [v/c]^2}$$

$$\text{for } v_{\text{electron}} = c^-; [v/c]^2 = 1 - 3.2828 \dots \times 10^{-17} \text{ for } v = \{1 - \frac{1}{2}(3.2828 \times 10^{-17})\} c \sim c$$

The Compton constant so relates the pre-spacetime formulation in the Planck-Stoney oscillation to the post-qbb cosmic evolution of the light path  $x=ct$  as:

$\sqrt{\alpha} \cdot l_{\text{planck}} \sqrt{\alpha} \cdot m_{\text{planck}} = \alpha h/2\pi c = \sqrt{\alpha} \cdot r_{\text{planck}} \sqrt{\alpha} \cdot M_{\text{curvature}} = \sqrt{\alpha} \cdot m_{ps} \sqrt{\alpha} \cdot r_{ps} = \alpha \cdot m_{ps} \cdot r_{ps} = m_{ec} \cdot r_{ec} = m_e R_e$  showing the limiting electron masses  $m_e$  and  $\alpha m_{ps}$  to be attained precisely at the wormhole mass  $m_{ps}$  as the modulation with the shrinking classical electron radius  $R_e$  to the wormhole radius  $r_{ps}$  as the linearization of the Compton wavelength of the wormhole event horizon  $\lambda_{ps} = 2\pi r_{ps}$ .

## Frequency permutation states in the monopolar velocity distribution

As the maximum frequency permutation state from the alpha-part of the relativistic force expression [Eq.XII-4] is always applied to the monopolar velocity  $v_{ps}$ ;  $df/dt|_{\text{max}} = f_{ps}^2 = 1/f_{ss}^2 = cf_{ps}/\lambda_{ps} = cf_{ps}/2\pi r_{ps}$  for an angular frequency  $\omega_{ps} = 2\pi f_{ps}$  as Compton frequency; the maximum monopolar velocity ratio  $\{v_{ps}/c\}^2$  applied to the mass  $m = m_{ec}$  will be proportional to that maximized frequency state.

The de Broglie group velocity  $v_{dB} = h/m_{ec}\lambda_{dB} = h/2\pi m_{ec} r_{dB}$  linearized so is recircularized in the monopolar velocity  $v_{ps}$  in the Compton constant  $m_{ec} \cdot r_{dB} = h/2\pi v_{ps}$  and with  $v_{ps}$  assuming  $c$  in the relativistic limit of the Compton radius.

For  $\langle R_{ec} \cdot m_{ec} = r_{ps} \cdot m_{ec} = \alpha h/2\pi c \rangle |_{\text{min}}$ , the minimized classical electron radius  $r_{ps}$  maximizes the monopolar speed of the electron in:

$\{v_{ps}/c\} = 1/\sqrt{1+1/4\pi^2\alpha^2} = 0.04579881$  as a conformal mapping of the wormhole radius of the electron onto its classical representation in the proportion  $10^{10} = 360R_e/2\pi r_{ps}$  in a correlation between circular measure in linearized radians and angular degrees. This is in correspondence to the wave nature expressed in the Compton and de Broglie wavelengths and of the particle nature from the Compton and de Broglie radii in an encompassing electromagnetic and electromagnetic monopolar emr-emmr interaction.

This monopolar  $\beta$  represents a magnetic mass  $m_{mm} = \mu_o e^2 (v_{ps}/c)^2 / 4\pi r_{ps} = R_e m_e (v_{ps}/c)^2 / r_{ps} = m_{ec} (v_{ps}/c)^2 = (2.09753100 \times 10^{-3}) m_{ec} = 3.4011525 \times 10^{-25} \text{ kg}$  for the alpha-energy  $E_{\alpha\omega} = m_{mm} c^2 = hf_{\alpha\omega} = 3.051037256 \times 10^{-8} \text{ J}^*$  for a total frequency integral of  $f_{\alpha\omega} = 4.59160179 \times 10^{25} = \sum f_{ss} = \sum m_{ss} c^2 / h = f_{\alpha\omega} / f_{ss} = 1.377480544 \times 10^{56}$  frequency self-states and mass quantum  $m_{ss}$  eigen inertia states by  $m_{ss} = hf_{ss}/c^2$  by the time instanton  $f_{ps} f_{ss} = 1 = E_{ps} \cdot e^*$  as universal and natural self-identity for the supermembrane  $E_{ps} E_{ss}$ , consisting of a high energy vibratory part  $E_{ps}$  and a low energy winding part  $E_{ss}$  in a mirror duality coupling.

This is a magnetic mass manifesting at the atomic scale at  $3.06100 \times 10^{-8} \text{ J}^*$  or  $190.5433 \text{ GeV}^*$  for a wavelength of  $\lambda_{mm} = h/m_{mm} c = 6.53382 \times 10^{-18} \text{ m}^*$  for a total electron mass  $m_{ec}/\sqrt{1 - (v_{ec}/c)^2} = \alpha m_{ps} = 1.621502875 \times 10^{-22} \text{ kg}^*$  as the Weyl mass having replaced the classical relativistic electron Restmass  $m_o$  by the quantum dynamic Compton Restmass  $m_{ec}$  as a function of the effective classical electron mass  $m_e$ .  $\alpha m_{ps} \{v_{ps}/c\}^2 = m_{mm}$  and so the Compton encompassing mass  $m_{ec}$  is reduced to the magnetic mass in the factor  $\{v_{ps}/c\}^2$  characterizing the mass-radius relationship for all electrons.

For  $\langle R_e \cdot m_e = \hbar \alpha / 2\pi c \rangle |_{\max}$ , the maximized classical electron radius  $R_e$  minimizes the monopolar speed of the electron in:

$$m_e = \hbar \alpha / 2\pi c R_e = k e^2 / R_e c^2 = \mu_0 e^2 / 4\pi R_e \text{ for } \{v_{ps}/c\} = 1/\sqrt{1+R_e^4/4\pi^2 \alpha^2 r_{ps}^4} = 1/\sqrt{1+(2\pi \cdot 10^{10}/360)^4/4\pi^2 \alpha^2}$$

$$= 1.50506548 \times 10^{-18}$$

and as the speed of the quantum relativistic mechanical electron at rest in the classical frame

$$v_{ps} = 1.50506548 \times 10^{-18} c = 0.45151964 \text{ (nanometers per second)*.}$$

The inversion speed of light is  $v_{ps} = 1/c = 3.3333...$  nanometers per second\* in modular brane duality to define an impedance 'bubble' characterizing astrophysical 'Hill spheres' for orbital equilibrium conditions for satellites and moons in a Radius of Hill Impedance/Hubble Time as  $R_{HI} = H_0/c$  as inversion displacement, which for a Universal Age of 19.12 Gy as Hubble time for a nodal Hubble constant oscillating between  $f_{ps}$  and  $H_0 = c/R_H = 58.04 \text{ (km/Mpc.s)*}$  for  $R_H = 1.59767545 \times 10^{26} \text{ m*}$  and becomes

$R_{HI} = 19.12 \text{ Gy}/c = 2.011229 \times 10^9 \text{ m*}$  and encompassing a 'planetary bubble radius' to approximately 5% to both the neighboring planets Venus and Mars.

This represents a magneto-monopolar mass  $m_{mm} = \mu_0 e^2 (v_{ps}/c)^2 / 4\pi R_e = m_e (v_{ps}/c)^2 = (2.265221 \times 10^{-36}) m_e$   
 $= 2.1045107 \times 10^{-66} \text{ kg*}$  for the alpha-energy  $E_{\alpha\omega} = m_{mm} c^2 = \hbar f_{\alpha\omega} = 1.8940596 \times 10^{-49} \text{ J*}$  for a total frequency integral of  $f_{\alpha\omega} = 2.84108945 \times 10^{-16} = \sum f_{ss} = \sum m_{ss} c^2 / \hbar = f_{\alpha\omega} / f_{ss} = 8.52326834 \times 10^{14}$  frequency self-states for the mass-frequency coupling  $m_{ss} = \hbar f_{ss} / c^2$ .

The classical electron Restmass  $m_o = m_e$  so is reduced to the magneto-monopolar mass  $m_{mm}$  in the factor  $\{v_{ps}/c\}^2$ .

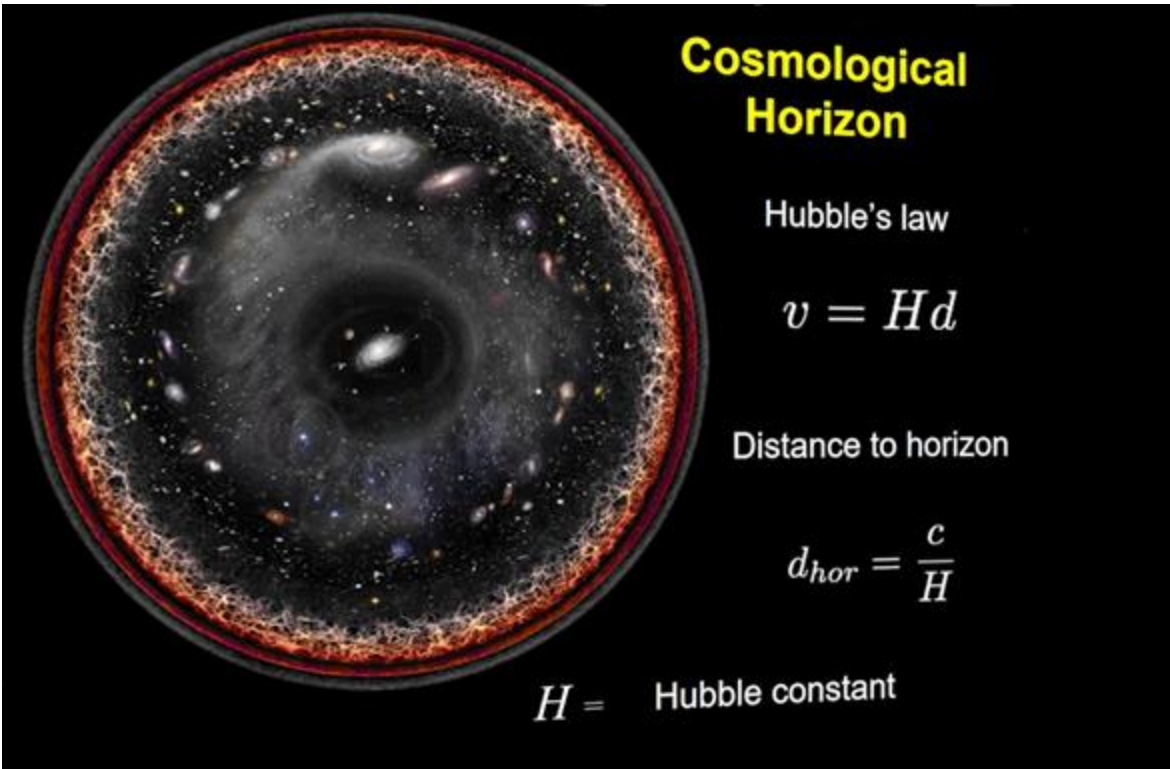



## The charge radius for the proton and neutrinos in QR

[BeginQuote]A scientific tug-of-war is underway over the size of the proton. Scientists cannot agree on how big the subatomic particle is, but a new measurement has just issued a forceful yank in favor of a smaller proton.

By studying how electrons scatter off of protons, scientists with the PRad experiment at Jefferson Laboratory in Newport News, Va., [sized up the proton's radius](https://www.sciencenews.org/article...-slightly-smaller-proton?tgt=more) at a measly 0.83 femtometers, or millionths of a billionth of a meter. That is about 5 percent smaller than the currently accepted radius, about 0.88 femtometers. <https://www.sciencenews.org/article...-slightly-smaller-proton?tgt=more>[EndofQuote]

It is the unitary interval between  $A=1/2$  and  $A=1$  which so determines the quantum nature for the quantum mechanics in the relativistic  $\beta$  distribution.

In particular for  $A=1/2$  and for  $\beta^2 = x = 0$ , the Compton constant defines the required electron Restmass of electro stasis as  $1/2 m_e c^2 = e^2 c^2 / 8\pi\epsilon_0 R_e$  for an effective electron size of  $R_e$ , whilst for  $A=1$   $m_e c^2 = e^2 c^2 / 4\pi\epsilon_0 R_e$  for a doubling of this radius to  $2R_e$  for  $\beta^2 = x = X$ .

Using the Rydberg Constant as a function of Alpha (and including the Alpha variation) as  $R_{y\infty} = \text{Alpha}^3 / 4\pi R_e = \text{Alpha}^2 \cdot m_e c / 2h = m_e e^4 / 8\epsilon_0^2 h^3 c = 11.1299104 \times 10^6$  [1/m]\* or  $11.1485125 \times 10^6$  [1/m] defines variation in the measured CODATA Rydberg constant of a factor  $10,973,731.6/11,148,512.5 = 0.98432\dots$

Subsequently, using the Rydberg energy levels for the electron-muon quantum energy transitions, will result in a discrepancy for the proton's charge radius in  $0.88 \times 0.98 \sim 0.866$  femto meters as a mean value for the charge radius of the proton.

$$\frac{1}{\lambda} = R_{\infty} \left( \frac{1}{n_1^2} - \frac{1}{n_2^2} \right) = \frac{m_e e^4}{8\epsilon_0^2 h^3 c} \left( \frac{1}{n_1^2} - \frac{1}{n_2^2} \right)$$

---

$$R_{\infty} = \frac{m_e e^4}{8\epsilon_0^2 h^3 c} = 10\,973\,731.568\,508\,(65) \text{ m}^{-1},$$

Energy for quantization  $n$ :  $E = -Ze^2 / 8\pi\epsilon_0 R = KE + PE = 1/2 mv^2 - Ze^2 / 4\pi\epsilon_0 R$  for angular momentum  $nh/2\pi = mvR$  with  $mv^2/R = Ze^2 / 4\pi\epsilon_0 R^2$

for  $v = Ze^2 / 2\epsilon_0 nh$  and  $R = n^2 h^2 \epsilon_0 / Ze^2 \pi m = 5.217 \times 10^{-11} \text{ m}^*$  for the minimum energy  $n=1$  for  $m = m_{\text{effective}} = m_e = 9.29061 \times 10^{-31} \text{ kg}^*$  and atomic number  $Z=1$  for hydrogen.

$E_n = hf_n = hc/\lambda_n = -Z^2 e^4 (\pi m_e) / (8\pi\epsilon_0^2 h^2 n^2) = -Z^2 e^4 (\pi e^2 / 4\pi\epsilon_0 R_e c^2) / (8\pi\epsilon_0^2 h^2 n^2) = -Z^2 e^6 / (32\pi R_e \epsilon_0^3 h^2 n^2 c^2)$  for  $1/\lambda_n = -Z^2 e^6 / (32\pi R_e \epsilon_0^3 h^3 n^2 c^3) = -Z^2 \cdot \text{Alpha}^3 / 4\pi n^2 R_e$  for eigen state  $n$  and Rydberg constant  $R_{y\infty} = \text{Alpha}^3 / 4\pi R_e = \text{Alpha}^2 \cdot m_e c / 2h = m_e e^4 / 8\epsilon_0^2 h^3 c$

In the Feynman lecture the discrepancy for the electron mass in the electromagnetic mass multiplier of  $4/3$  is discussed. [http://www.feynmanlectures.caltech.edu/II\\_28.html](http://www.feynmanlectures.caltech.edu/II_28.html)

Its solution resides in the unitary interval for A, as the arithmetic mean of:  $\frac{1}{2}\{\frac{1}{2}+1\} = 3/4$  as the present internal magnetic charge distribution of the electron, namely as a trisection of the colour charge in  $3 \times \frac{1}{3} = 1$  negative fraction charges in the quantum geometry of the electron indicated below in this paper.

The classical size for the proton so is likewise approximated at the mean value of its own colour charge distribution, now consisting of a trisected quark-gluon-anti-neutrino kernel of  $3 \times \frac{1}{3} = 2$  positive fraction charges, which are 'hugged' by a trisected 'Inner Mesonic Ring' (d-quark-KIR) as a contracted 'Outer Leptonic Ring' (s-quark-KOR) for the manifestation of the electron-muon-tauon lepton family of the standard model.

For the electrostatic electron the  $\beta$  distribution at  $A = \frac{1}{2}$ , the Compton constant gives  $m_{ec}f_{ec} = m_e R_e$  for  $\beta^2 = 0$  and at  $A = 1$ , the Compton constant gives  $m_{ec}f_{ec} = \frac{1}{2} m_e \cdot 2R_e$  for  $\beta^2 = X$  and as the mean for a unitary interval is  $\frac{1}{2}$ , the electron radius transforms into the protonic radius containing monopolar charge as internal charge distribution in  $R_p = \frac{1}{2} X R_e$  and where the factor X represents the symmetry equilibrium for a  $\beta = (v/c)$  velocity ratio distribution for the effective electron Restmass  $m_e$  proportional to the spacial extent of the electron.

For the proton then, its 'charge distribution' radius becomes averaged as  $R_{proton} = 0.85838052 \times 10^{-15} \text{ m}^*$  as a reduced classical electron radius and for a speed for the self-interactive or quantum relativistic electron of  $2.96026005 \times 10^{-13} \text{ c}$ .

This quantum relativistic speed reaches its  $v/c = 1$  limit at the instanton boundary and defines a minimum quantum relativistic speed for the electron at  $v_e = 1.50506548 \times 10^{-18} \text{ c}$  for its electrostatic potential, where  $U_e = \int \{q^2 / 8\pi\epsilon_0 r^2\} dr = q^2 / 8\pi\epsilon_0 R_e = \frac{1}{2} m_e c^2$  for a classical velocity of  $v_e = 0$  in a non-interacting magnetic field  $B = 0$ .

$2U_e = m_e c^2$  so implies a halving of the classical electron radius to obtain the electron mass  $m_e = 2U_e / c^2$  and infers an oscillating nature for the electron size to allow a synergy between classical physics and that of quantum mechanics.

## A mapping of the atomic nucleus onto the thermodynamic universe of the hyperspheres

We consider the universe's thermodynamic expansion to proceed at an initializing time  $t_{ps} = t_{ss}$  at lightspeed for a light path  $x = ct$  to describe the hypersphere radii as the volume of the inflaton made manifest by the instanton as a lower dimensional subspace and consisting of a summation of a single spacetime quantum with a quantized toroidal volume  $2\pi^2 r_{weyl}$  and where  $r_{weyl} = r_{ps}$  is the characteristic wormhole radius for this basic building unit for a quantized universe (say in string parameters given in the Planck scale and its transformations).

At a time  $t_G$ , say so 18.85 minutes later, the count of space time quanta can be said to be  $9.677 \times 10^{102}$  for a universal 'total hypersphere radius' of about  $r_G = 3.391558005 \times 10^{11}$  meters and for a G-Hypersphere volume of so  $7.69 \times 10^{35}$  cubic meters from  $N\{2\pi^2 \cdot r_{ps}^3\} = \text{Volume} = 2\pi^2 \cdot R_{Hk}^3$ .

{This radius is about 2.3 Astronomical Units (AU's) and about the distance of the Asteroid Belt from the star Sol in a typical (our) solar system.}

This modelling of a mapping of the quantum micro-scale onto the cosmological macro-scale can then be used to indicate the mapping of the wormhole scale onto the scale of the sun as a quasi-conformal scaling of the fermi scale of the classical electron radius onto a typical gravitational star system.

$r_{\text{weyl}}/R_{\text{sun}}=R_e/r_e$  for  $R_{\text{sun}}=r_{\text{weyl}}.r_e/R_e=1,971,030$  meters. This gives an 'inner' solar core of diameter about  $3.94 \times 10^5$  meters.

As the classical electron radius is quantized in the wormhole radius in the formulation  $R_e=10^{10}r_{\text{weyl}}/360$ , rendering a fine structure for Planck's Constant as a 'superstring parametric':  $h=2\pi r_{\text{weyl}}/2R_e c^3$ ; the 'outer' solar scale becomes  $R_{\text{sun[0]}}=360.R_{\text{sun}}=7.092 \times 10^8$  meters as the observed radius for the solar disk.

19 seconds later; a F-Hypersphere radius is about  $r_F=3.451077503 \times 10^{11}$  meters for a F-count of so  $1.02 \times 10^{103}$  spacetime quanta for the thermodynamically expanding universe from the instanton.

We also define an E-Hypersphere radius at  $r_E=3.435971077 \times 10^{14}$  meters and an E-count of so  $10^{112}$  to circumscribe this 'solar system' in so 230 AU.

We so have 4 hypersphere volumes, based on the singularity-unit and magnified via spacetime quantization in the hyperspheres defined in counters G, F and E. We consider these counters as somehow fundamental to the universe's expansion, serving as boundary conditions in some manner.

As counters, those googol-numbers can be said to be defined algorithmically and to be independent on mensuration physics of any kind.

<https://cosmosdawn.net/index.php/en...stanton-to-continuo-n-four-pillars-of-creation>

Should we consider the universe to follow some kind of architectural blueprint; then we might attempt to use our counters to be isomorphic (same form or shape) in a one-to-one mapping between the macro-cosmos and the micro-cosmos.

So we define a quantum geometry for the nucleus in the simplest atom, say Hydrogen.

The hydrogenic nucleus is a single proton of quark-structure udu and to which we assign a quantum geometric template of Kernel-Inner Ring-Outer Ring (K-IR-OR), say in a simple model of concentricity.

We set the up-quarks (u) to become the 'smeared out core' in say a tripartition uuu so allowing a substructure for the down-quark (d) to be u+Inner Ring (IR).

A down-quark so is a unitary ring coupled to a kernel-quark. The proton's quark-content so can be rewritten and without any loss of any of the properties and generalities in unitary symmetry obtained from the Standard Model of particle physics and associated with the quantum conservation laws; as proton  $\Rightarrow$  udu  $\Rightarrow$  uuu+IR = KKK+IR. We may now label the Inner Ring as Mesonic and the Outer Ring as Leptonic.

The Outer Ring (OR) is so definitive for the strange quark in quantum geometric terms:  $s=u+OR$ .

A neutron's quark content so becomes neutron=dud=KIR.K.KIR with a 'hyperon resonance' in the  $\lambda=sud=KOR.K.KIR$  and so allowing the neutron's beta decay to proceed in disassociation from a nucleus (where protons and neutrons bind in meson exchange); i.e. in the form of 'free neutrons'.

The neutron decays in the oscillation potential between the mesonic inner ring and the leptonic outer ring as the 'ground-energy' eigenstate.

There actually exist three uds-quark states which decay differently via strong, electromagnetic and weak decay rates in the uds ( $\Sigma^0$  Resonance); usd ( $\Sigma^0$ ) and the sud ( $\Lambda^0$ ) in increasing stability.

This quantum geometry then indicates the behaviour of the triple-uds decay from first principles, whereas the contemporary standard model does not, considering the u-d-s quark eigenstates to be quantum geometrically undifferentiated.

The nuclear interactions, both strong and weak are confined in a 'Magnetic Asymptotic Confinement Limit, coinciding with the Classical Electron Radius  $R_e = k_e e^2 / m_e c^2$  and in a scale of so 3 Fermi or  $2.8 \times 10^{-15}$  meters. At a distance further away from this scale, the nuclear interaction strength vanishes rapidly.

The wave nature of the nucleus is given in the Compton-Radius  $R_{\text{compton}} = h / 2\pi m c$  with  $m$  the mass of the nucleus, say a proton; the latter so having a scale reduced from  $R_e$  by some partitioning of the classical electron size.

As the Planck Oscillator  $E_o = \frac{1}{2} h f_o$  of the Zero-Point-Energy or ZPE as Vortex-Potential-Energy or VPE defines its ground state at half its effective energy of  $E_k = h f_k$ , and as a conformal mapping from the string energy scale of the inflaton onto the qbb scale of the instanton in the  $E_{\text{weyl}} = E_{\text{ps}} = /e^* = 1/2 R_e c^2 |_{\text{mod}}$  gauge boson; we define a subatomic scale at half of  $R_e$  as  $r_{\text{mean}} = \frac{1}{2} R_e$ .

The wave-matter (after de Broglie generalizing wave speed  $v_{\text{dB}}$  from  $c$  in  $R_{\text{compton}}$ ) then relates the classical electron radius as the 'confinement limit' to the Compton scale in the electromagnetic fine structure constant in  $R_e = \text{Alpha} \cdot R_{\text{compton}}$ .

The extension to the hydrogen-atom is obtained in the expression  $R_e = \text{Alpha}^2 \cdot R_{\text{bohr1}}$  for the first Bohr-Radius as the 'ground energy' of so 13.7 eV at a scale of so  $10^{-10}$  meters (Angstroems).

These 'facts of measurements' of the standard models now allow our quantum geometric correspondences to assume cosmological significance in their isomorphic mapping. We denote the Outer Ring as the classical electron radius and introduce the Inner Ring as a mesonic scale contained within the geometry of the proton and all other elementary baryonic- and hadronic particles.

Firstly, we define a mean macro-mesonic radius as:  $r_M = \frac{1}{2}(r_F + r_G) = 3.421317754 \times 10^{11}$  meters and set the macro-leptonic radius to  $r_E = 3.435971077 \times 10^{14}$  meters.

Secondly, we map the macro-scale onto the micro-scale, say in the simple proportionality relation for the micro-mesonic scale  $R_{\text{mean}} = R_e \cdot r_M / r_E = 2.765931439 \times 10^{-18}$  meters.

So reducing the apparent measured 'size' of a halving of  $R_e$  in a factor about 1000 gives the scale of the sub-nuclear mesonic interaction, say the strong interaction coupling by pions.

## The Higgsian Scalar-Neutrino

The (anti)neutrinos are part of the electron mass in a decoupling process between the kernel and the rings. Neutrino mass is so not cosmologically significant and cannot be utilized in 'missing mass' models'.

We may define the kernel-scale as that of the singular spacetime-quantum unit itself, namely as the wormhole radius  $r_{\text{weyl}} = r_{\text{ps}} = 10^{-22} / 2\pi$  meters.

Before the decoupling between kernel and rings, the kernel-energy can be said to be strong-weakly coupled or unified to encompass the gauge-gluon of the strong interaction and the gauge-weakon of the weak interaction defined in a coupling between the leptonic Outer Ring and the Kernel and bypassing the mesonic Inner Ring.

So for matter, a W-Minus ( weakon) must consist of a coupled lepton part yet linking to the strong interaction via the kernel part. If now the colour-charge of the gluon transmutes into a 'neutrino-colour-charge'; then this decoupling will not only define the mechanics for the strong-weak nuclear unification coupling; but also, the energy transformation of the gauge-colour charge into the gauge-lepton charge.

There are precisely 8 gluonic transitive energy permutation eigenstates between a 'radiative-additive' Planck energy in  $W(\text{hite})=E=hf$  and an 'inertial-subtractive' Einstein energy in  $B(\text{lack})=E=mc^2$ , which describe the baryonic- and hyperonic 'quark-sectors' in:  $mc^2=BBB, BBW, WBB, BWB, WBW, BWW, WWB$  and  $WWW=hf$ . The permutations are cyclic and not linearly commutative. For mesons (quark-antiquark eigenstates), the permutations are  $BB, BW, WB$  and  $WW$  in the  $SU(2)$  and  $SU(3)$  Unitary Symmetries.

So generally, we may state, that the gluon is unified with a weakon before decoupling; this decoupling 'materializing' energy in the form of mass, namely the mass of the measured 'weak-interaction-bosons' of the standard model ( $W^-$  for charged matter;  $W^+$  for charged antimatter and  $Z^0$  for neutral mass-currents say). Experiment shows, that a  $W^-$  decays into spin-aligned electron-antineutrino or muon-antineutrino or tauon-antineutrino pairings under the conservation laws for momentum and energy.

So, using our quantum geometry in the Unified Field of Quantum Relativity or UFoQR, we realize, that the weakly decoupled electron must represent the Outer Ring, and just as shown in the analysis of Quantum Electro-Dynamics or QED.

Then it can be inferred, that the Electron's Anti-neutrino represents a transformed and materialized gluon via its colour charge, now decoupled from the kernel and in a way revisiting the transformation of a bosonic ancestry for the fermionic matter structures, discussed further on in the string class transformations of the inflaton era. There exists so a natural and generic supersymmetry in the quark-lepton hierarchy and no additional supersymmetric particles are necessary.

Then the Outer Ring contracts along its magneto axis defining its asymptotic confinement and in effect 'shrinking the electron' in its inertial and charge- properties to its experimentally measured 'point-particle-size'.

Here we define this process as a mapping between the electronic wavelength  $2\pi R_e$  and the wormhole perimeter  $\lambda_{\text{weyl}}=2\pi r_{\text{weyl}}$ .

But in this process of the 'shrinking' classical electron radius towards the gluonic kernel; the mesonic ring will be encountered and it is there, that any mass inductions should occur to differentiate a massless lepton gauge-eigenstate from that manifested by the weakon precursors.

{Note: Here the  $W^-$  inducing a lefthanded neutron to decay weakly into a lefthanded proton, a lefthanded electron and a righthanded antineutrino. Only lefthanded particles decay weakly in CP-parity-symmetry violation, effected by neutrino-gauge definitions from first principles}.

This then indicates a neutrino-oscillation potential at the Inner Ring-Boundary. Using our proportions and assigning any neutrino-masses  $m_\nu$  as part of the electron mass  $m_e$ , gives the following proportionality as the mass eigenvalue of the Tau-(Anti)Neutrino as Higgsian Mass Induction in the Weak Nuclear Interaction at the Mesonic Inner Ring Boundary within the subatomic quantum geometry utilized as the dynamic interaction space:

$$m_{\text{Higgs/Tauon}} = m_e \lambda_{\text{weyl}} \cdot r_E / (2\pi r_M R_e) = m_e \lambda_{\text{weyl}} \cdot r_E / (2\pi r_M R_e) \sim 5.345878435^{-36} \text{ kg}^* / 2.994971267 \text{ eV}^* \dots [\text{Eq.XII-8}]$$

So we have derived, from first principles, a (anti)neutrino mass eigenstate energy level of 3 eV as the appropriate energy level for any (anti)neutrino matter interaction within the subatomic dynamics of the nuclear interaction.

This confirms the Mainz, Germany Result (Neutrino 2000), as the upper limit for neutrino masses resulting from ordinary Beta-Decay and indicates the importance of the primordial beta-decay for the cosmogenesis and the isomorphic scale mappings referred to in the above.

The hypersphere intersection of the G- and F-count of the thermodynamic expansion of the mass-parametric universe so induces a neutrino-mass of 3 eV\* at the 2.765931439x10<sup>-18</sup> metre marker.

The more precise G-F differential in terms of eigenenergy is 0.052 eV as the mass-eigenvalue for the Higgs-(Anti)neutrino (which is scalar of 0-spin and constituent of the so-called Higgs Boson as the kernel-Eigenstate). This has been experimentally verified in the Super-Kamiokande (Japan) neutrino experiments published in 1998 and in subsequent neutrino experiments around the globe, say Sudbury, KamLAND, Dubna, MinibooNE and MINOS.

Recalling the Cosmic scale radii for the initial manifestation of the primordial 'Free Neutron (Beta-Minus) Decay', we rewrite the Neutrino-Mass-Induction formula:

$r_E = 3.435971077 \times 10^{14}$  meters and an E-count of  $(26 \times 65^{61}) = 1.00 \times 10^{112}$  spacetime quanta:  
 $m_{\nu\text{Higgs-E}} = m_{\nu\text{electron}} = m_e \cdot r_{ps} \{r_E/r_E\}/R_e = 5.323079952 \times 10^{-39}$  kg\* or 0.00298219866 eV\* as Weak Interaction Higgs Mass induction.

But in this limiting case the supermembrane modular duality of the instanton identity  $E_{ps} \cdot e^* = 1$  applied to the Compton constant will define the limiting neutrino mass for the electron as a modular neutrino mass per displacement quantum defined in the Compton constant  $m_e R_e = \alpha m_p l_p = h\alpha/2\pi c$  and for a modulation displacement factor  $\{R_e^2/r_{ps}\}$  as monopolar displacement current as mass equivalence, the Planck Length bounce displacement  $x = \sqrt{\alpha} \cdot l_p = e/c^2$  for finestructure unification  $k_e G_o = 1$  and the Action Law  $\{\text{Action } h = ee^* \text{ Charge}^2\}$  via mass  $[m] = h/cx = hc/e = [ec]$  for  $[i]_{\text{monopolar}} = [ec]_{\text{monopolar}}/\text{displacement } x$

$$|m_{\nu\text{Higgs-E}} = m_{\nu\text{electron}}|_{\text{mod}} = m_e \cdot r_{ps} \{R_e^2/r_{ps}\}/R_e = \{\alpha h/2\pi c\}|_{\text{mod}} = 2.58070199 \times 10^{-45} \text{ kg}[m/m]^* \dots [\text{Eq.XII-9}]$$

$r_F = 3.451077503 \times 10^{11}$  meters for the F-count of  $(13 \times 66^{56}) = 1.02 \times 10^{103}$  spacetime quanta:  
 $m_{\nu\text{Higgs-F}} = m_{\nu\text{muon}} = m_e \cdot r_{ps} \{r_E/r_F\}/R_e = 5.299779196 \times 10^{-36}$  kg\* or 2.969144661 eV\* as Weak Interaction Higgs Mass induction.

$r_G = 3.39155805 \times 10^{11}$  meters for the G-count of  $(67 \times 36^{65}) = 9.68 \times 10^{102}$  spacetime quanta:  
 $m_{\nu\text{Higgs-G}} = m_{\nu\text{tauon}} = m_e \cdot r_{ps} \{r_E/r_G\}/R_e = 5.392786657 \times 10^{-36}$  kg\* or 3.021251097 eV\* as Weak Interaction Higgs Mass Induction.

**The mass difference for the Muon-Tauon-(Anti)Neutrino Oscillation, then defines the Mesonic Inner Ring Higgs Induction: .....[Eq.XII-10]**

$$m_{\nu\text{Higgs}} = m_e \cdot r_{ps} \{r_E/r_G - r_E/r_F\}/R_e = 9.3007461 \times 10^{-38} \text{ kg}^* \text{ or } 0.05210643614 \text{ eV}^* \text{ as the Basic Cosmic (Anti)Neutrino Mass.}$$

This Higgs-Neutrino-Induction is 'twinned' meaning that this energy can be related to the energy of so termed 'slow- or thermal neutrons' in a coupled energy of so twice 0.0253 eV for a thermal equilibrium at so 20° Celsius and a rms-standard-speed of so 2200 m/s from the Maxwell statistical distributions for the kinematics. The (anti)neutrino energy at the  $R_E$  nexus for  $R_E = r_{ps} \sqrt[3]{(26 \times 65^{61})} m^*$  and for

$$m_{\nu\text{Higgs-E}} = m_{\nu\text{electron}} = \mu_o e^2 c^2 \cdot r_{ps} / 4\pi R_e^2 c^2 = 30e^2 \lambda_{ps} / 2\pi c R_e^2 \text{ or } \mu_o \{\text{Monopole GUT masses } ec\}^2 r_{ps} / 4\pi R_e^2 c^2 = 2.982198661 \times 10^{-3} \text{ eV}^* \text{ and for:}$$

$$m_{\nu\text{Electron}} c^2 = m_{\nu} (v_{\text{Tauon}})^2 c^2 = m_{\nu} (v_{\text{Muon}}^2 + v_{\text{Higgs}}^2) c^2 = \mu_o \{\text{Monopole GUT masses } ec\}^2 r_{ps} / 4\pi R_e^2 \dots \dots [\text{Eq.XII-11}]$$

This can also be written as  $m_{\nu\text{Higgs-E}}=m_{\text{velectron}}=m_{\nu\text{Tauon}}^2$  to define the 'squared' Higgs (Anti)Neutrino eigenstate from its templated form of the quantum geometry in the UfoQR.

Subsequently, the Muon (Anti)Neutrino Higgs Induction mass becomes defined in the difference between the masses of the Tau-(Anti)Neutrino and the Higgs (Anti)Neutrino.

$$\begin{aligned} m_{\nu\text{Tauon}} &= B^4G^4R^4[0]+B^2G^2R^2[-\frac{1}{2}] = B^6G^6R^6[-\frac{1}{2}] = \sqrt{(m_{\text{velectron}})} = \sqrt{(0.002982)} = 0.0546\dots \text{ eV}^* \\ m_{\nu\text{Higgs}} &= B^4G^4R^4[0] = m_e\lambda_{ps}\cdot r_E\{1/r_G-1/r_F\}/(2\pi R_e) \sim 9.301\times 10^{-38} \text{ kg}^* \text{ or } 0.0521\dots \text{ eV}^* \\ m_{\nu\text{Muon}} &= B^2G^2R^2[-\frac{1}{2}] = \sqrt{(m_{\nu\text{Tauon}}^2 - m_{\nu\text{Higgs}}^2)} = \sqrt{(0.00298-0.00271)} = \sqrt{(0.00027)} = 0.0164\dots \text{ eV}^* \\ m_{\nu\text{Electron}} &= B^2G^2R^2[-\frac{1}{2}] = (m_{\nu\text{Tauon}})^2 = (0.054607\dots)^2 = 0.002982\dots \text{ eV}^* \end{aligned}$$

This energy self-state for the Electron (Anti)Neutrino then manifests in the Higgs Mass Induction at the Mesonic Inner Ring or IR as the squared mass differential between two (anti)neutrino self-states as:

$$(m_{\nu 3} + m_{\nu 2}) \cdot (m_{\nu 3} - m_{\nu 2}) = m_{\nu 3}^2 - m_{\nu 2}^2 = 0.002981\dots \text{ eV}^{*2}$$

to reflect the 'squared' energy self-state of the scalar Higgs (Anti)Neutrino as compared to the singlet energy eigen state of the base (anti)neutrinos for the 3 leptonic families of electron-positron and the muon-antimuon and the tauon-antitauon.

The Electron-(Anti)Neutrino is massless as base-neutrino weakon eigenstate and inducted at  $R_E$  at 0.00298 eV\*.

The Muon-(Anti)Neutrino is also massless as base-neutrino weakon eigenstate and inducted at the Mesonic Ring F-Boundary at 2.969 eV\* with an effective Higgsian mass induction of 0.0164 eV\*.

All (anti)neutrinos gain mass energy however when they become decoupled from their host weakon; either a  $W^-$  for matter or a  $W^+$  for antimatter.

So as constituents of the weakon gauge for the weak interaction the electron- and muon (anti)neutrinos are their own antiparticles and so manifest their Majorana qualities in the weak interaction. Once emitted into the energy-momentum spacetime however, the monopolar nature from their self-dual GUT/IIB monopole mass  $[ec]_{\text{uimd}}$  or their energy  $[ec^3=2.7\times 10^{16} \text{ GeV}^*]_{\text{unifiedinmodularuality}}$  manifests in their masses.

The premise of the older Standard Model for a massless (anti)neutrino so remains valid for them in respect to their Majorana-coupling their lepton partners as the weakon agents in their quantum geometric templates; but is modified for 'free' (anti)neutrinos as Dirac particles.

The Tauon-(Anti)Neutrino is not massless with inertial eigenstate inducted at the Mesonic Ring G-Boundary at 3.021 eV\* and averaged at 3.00 eV\* as  $\sqrt{(0.05212+0.01642)} = 0.0546 \text{ eV}^*$  as the square root value of the ground state of the Higgs inertia induction. The neutrino flavour mechanism, based on the Electron (Anti)Neutrino so becomes identical in the Weakon Tauon-Electron-Neutrino oscillation to the Scalar Muon-Higgs-Neutrino oscillation.

The weakon kernel-eigenstates are 'squared' or doubled ( $2\times 2=2+2$ ) in comparison with the gluonic-eigenstate (one can denote the colour charges as  $(R^2G^2B^2)[\frac{1}{2}]$  and as  $(RGB)[1]$  respectively say and with the [] bracket denoting gauge-spin and RGB meaning colours Red-Green-Blue).

The scalar Higgs-Anti(Neutrino) becomes then defined in:  $(R^4G^4B^4)[0]$  and the Tauon Anti(Neutrino) in  $(R^6G^6B^6)[\frac{1}{2}]$  in doubling of the singular  $R^2G^2B^2$  inflexion points in the UfoQR for odd  $\pi$  Gravitational Interaction GI and even  $\pi$  Electromagnetic Interaction EMI. The GI points define BGR color charges, and the EMI points define RGB color charges for (anti)neutrino generation as a function of the 12 interwoven monopolar current loops (see diagram below).

The reason as to why no right-handed neutrinos and left-handed antineutrinos manifest in the UfoQR crystallizes in the distribution of the odd and even pi-nodes established in the base templates of the QBBS. The Dark Matter agent of the RMP manifests in the  $0^\circ - 120^\circ - 180^\circ - 200^\circ$  interval in the UfoQR and so includes an odd  $\pi$  GI monopolar current coordinate; whilst the Anti-RMP manifests in the  $520^\circ - 540^\circ - 600^\circ - 720^\circ$  interval with  $540^\circ$  as  $3\pi+\pi/6$  in between the odd  $\pi$  GI at  $3\pi$  and the even  $\pi$  EMI at  $4\pi$ .

The Anti-RMP as an Anti-Dark Matter agent is therefore suppressed in that the  $B^2G^2R^2[-\frac{1}{2}]$  Majorana neutrino at  $720^\circ$  flipping into a  $R^2G^2B^2[+\frac{1}{2}]$  Majorana Anti-neutrino at  $600^\circ$  cannot then flip into a Majorana neutrino at the  $540^\circ$  nexus and remains as a Majorana Anti-neutrino at the  $520^\circ$  coordinate to suppress the manifestation of the Anti-RMP  $M^2C^2Y^2[+1]$  as the spin induced form of the scalar Anti-Higgs Boson or Anti-HB  $M^2C^2Y^2[0]$ .

The right-handed  $R^2G^2B^2[+\frac{1}{2}]$  Majorana Antineutrino so continues to the intersection monopolar current coordinate as the  $2\pi$ -EMI 3-junction where it meets and merges with a left-handed Majorana Antineutrino which flipped from  $R^2G^2B^2[+\frac{1}{2}]$  Majorana Antineutrino at  $0^\circ$  into a  $B^2G^2R^2[-\frac{1}{2}]$  Majorana Neutrino at  $120^\circ$  before flipping its color charge permutation cyclicity from anticyclic  $B^2G^2R^2$  to cyclic  $R^2G^2B^2$  into a  $R^2G^2B^2[-\frac{1}{2}]$  Majorana Antineutrino at  $180^\circ$  to complete its unified field Weak-Nuclear matter-antimatter interaction in conjunction with the manifested dark matter agency of the RMP[-1] and to create the template for the Higgs Anti-neutrino  $R^2G^2B^2[-\frac{1}{2}] + R^2G^2B^2[+\frac{1}{2}] = R^4G^4B^4[0]$ .



## Neutrino Discrepancies and Higgs Neutrino Oscillation Masses

A history of neutrino measurements is described as a reply to a published video by Sabine Hossenfelder from September 21<sup>st</sup>, 2021

<https://youtu.be/p118Ybx FtGg>



# The Unified Gauge Parameter Field of Quantum Relativity

Primary-Secondary-Tertiary Colour Triplets of the Chromaticity Unities in the UFOQR 1-2-3-4-5-6-7-8-9-10-11-12-13 Anticolours for 8 Gluon Permutations in Energy gravitational  $E=mc^2$  for B(lack) and Energy radiative  $E=hf$  for W(hite) R+C and O+A and Y+B and L+I and G+M and T+P and C+R and A+O and B+Y and I+L and M+G and P+T and R+C

Gluon RGB=(RG)B=YB=CR=MG=YB=CR=MG=RGB

for: {BBB;BBW;BWB;BWW;WBB;WBW;WWB;WWW} hyperonic triplets and {BB;BW;WB;WW} mesonic doublets

R(ed)-O(range)-Y(ellow)-L(ime)-G(reen)-T(urquoise)-C(yan)-A(quamarine)-B(lue)-I(ndigo)-M(agenta)-P(urple)-R(ed)

The 12 Junction-Loops of the Unified Field Natural Current Field in Quantum Relativity Extent:  $4\lambda_{ps}$  & Amplitude= $\lambda_{ps}/2\pi$

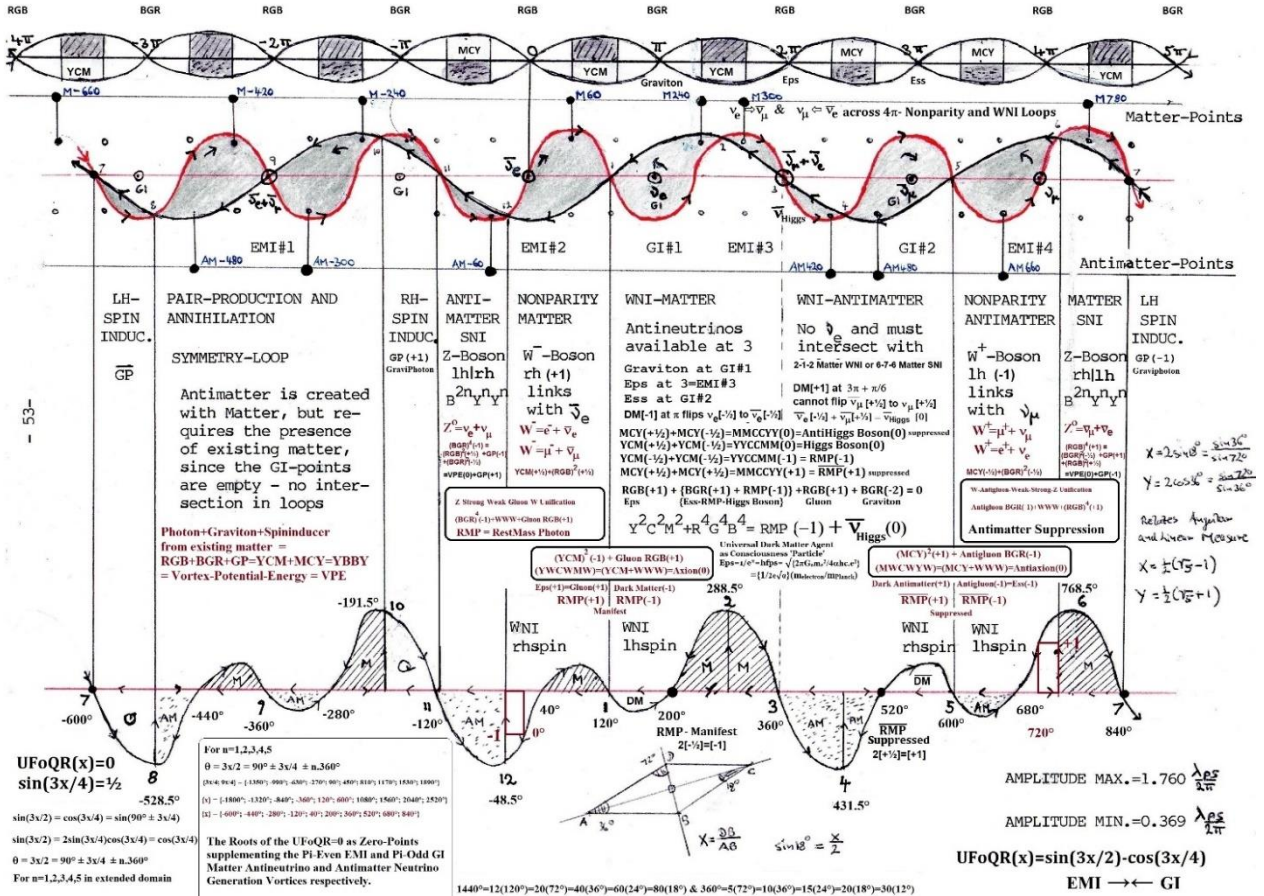

**EM(M)|=ElectroMagnetic (Monopolic) Radiation Interaction = Unified Field of QR before spacetime creation {Inflation to Quantum Big Bang} without Gravitational Interaction GI**  
**Metaphysical Abstraction of Mathimatia Supersymmetry by Logos Definition in Radiation-Antiradiation Symmetry**

**Möbian-Klein Twosided 11D-Mirror SelfIntersection :** RGB(+1)+RGB(-1) ⇒ RRGGBB(0) ⇒ YCM(0)+YCM(0) ⇒ BBGGRR(0) ⇒ MCY(0)+MCY(0) ⇒ BGR(-1)+BGR(+1)

Eps=RGB(+1) at 0° .....Ess=RGB(-1) at 360° .....Eps=BGR(-1) at 180° Inflexion Ess=BGR(+1)  
 Ess=RGB(+1) at 0° .....Eps=RGB(+1) at 360° .....Breaking of the metaphysical supersymmetry in quantum spin to allow the birth of the Graviton and matter-antimatter symmetry, suppressing however the matter-antimatter symmetry in the reformulation of antiradiation  
 [Encoded as the retracing of the 'steps' of the creator' --Ezekiel.28.13-19; Isaiah.14.12-14]

**Unified Field of QR in the 11D-Membrane Inflation, followed by a Quantum Big Bang of Relativistic Thermodynamic Cosmology**  
**Physicalisation of the Metaphysical Precursor in an inherent Matter-Antimatter Asymmetry**

**Möbian-Klein Onesided 10D/12D-Mirror SelfIntersection as the Goldstone Boson Unification of all Interactions in the UFOQR:**  
**RGB(+1)+BGR(+1)+RGB(+1)+BGR(-2)+YYCCMM(-1) = EMI Eps-Photon + WNI Ess-Antiphoton + SNI Gluon + Graviton + EMMR-RMP**  
**⇒ MGGM(+2)+MGGM(-1)+YYCCMM(-1) = VPE(+2)+VPE(-1)+YYCCMM(-1) = VPE(+1)+YYCCMM(-1) = EMMR UFOQR Unification**

The Ess-Anti-Photon(+1) is suppressed as Goldstone ambassador gauge in spin +1 by The SNI ambassador Gluon and is suppressed in colour charge BGR by the GI gauge ambassador Graviton. The birth of the Graviton demands a net spin of +1 of the Vortex-Potential Energy or VPE/ZPE to become neutralized by the fifth gauge ambassador of the RMP with spin -1 as the gauge ambassador of the Goldstone Boson as the primal gauge ambassador for the consciousness energy interaction encompassing all particular constituents in the Unified Field of Quantum Relativity.

The 'missing' left-handed Anti-neutrino so is integrated or absorbed by the scalar or sterile Higgs Anti-neutrino with a natural suppression of the scalar or sterile Higgs neutrino by the not manifested RMP[+1] and Anti-HB[0] templates in the UfoQR.

$$R^2G^2B^2[+\frac{1}{2}]-\pi \rightarrow B^2G^2R^2[-\frac{1}{2}]-\pi \rightarrow R^4G^4B^4[0] \leftarrow \pi - R^2G^2B^2[+\frac{1}{2}] \leftarrow \pi - B^2G^2R^2[-\frac{1}{2}] \text{ across a } 4\pi \text{ interval.}$$

The scalar Higgs-Anti(Neutrino) then is defined in  $(R^4G^4B^4)[0]$  and the Tauon Anti(Neutrino) in  $(R^6G^6B^6)[\frac{1}{2}]$ .

The twinned neutrino state so becomes apparent in a coupling of the scalar Higgs-Neutrino with a massless base neutrino in a  $(R^6G^6B^6)[0+\frac{1}{2}]$  mass-induction template.

The Higgs-Neutrino is bosonic and so not subject to the Pauli Exclusion Principle; but quantized in the form of the FG-differential of the 0.0521 Higgs-Restmass Induction.

Subsequently all experimentally observed neutrino-oscillations should show a stepwise energy induction in units of the Higgs-neutrino mass of 0.0521 eV.

This was the case in the Super-Kamiokande experiments; and which was interpreted as a mass-differential between the muonic and tauonic neutrino forms.

$$\begin{aligned} m_{\nu\text{Higgs}} + m_{\nu\text{electron}} &= m_{\nu\text{Higgs}} + (m_{\nu\text{Tauon}})^2 \text{ for the 'squared' ground state of a massless base (anti)neutrino for a} \\ &\text{perturbation Higgsian (anti)neutrino in } (m_{\nu\text{Tauon}})^2 \\ &= (m_{\nu\text{Higgs}} + \Delta)^2 = m_{\nu\text{Electron}} \text{ for a quadratic } m_{\nu\text{Higgs}}^2 + 2m_{\nu\text{Higgs}}\Delta + \Delta^2 = 0.002982 \text{ from } (m_{\nu\text{Higgs}} + \Delta) = \nu(m_{\nu\text{electron}}) \\ &\text{and for a } \Delta = \nu(m_{\nu\text{electron}}) - m_{\nu\text{Higgs}} = m_{\nu\text{Tauon}} - m_{\nu\text{Higgs}} = 0.0546 \text{ eV} - 0.0521 \text{ eV} = 0.0025 \text{ eV.} \end{aligned}$$

$$\begin{aligned} m_{\nu\text{Higgs}} + \Delta &= 0.0521 + 0.0025 = (m_{\nu\text{Higgs}}) + (m_{\nu\text{electron}}) - 0.00048 = m_{\nu\text{tauon}} = 0.0521 + 0.00298 - 0.00048 + \dots \\ &= 0.0546 \text{ eV}^* \text{ as a perturbation expression for the 'squared' scalar Higgs (Anti)Neutrino.} \end{aligned}$$

$$\begin{aligned} (m_{\nu\text{Muon}} - m_{\nu\text{Electron}})\{(m_{\nu\text{Muon}} + m_{\nu\text{Electron}}) - (m_{\nu\text{Muon}} - m_{\nu\text{Electron}})\} &= 2m_{\nu\text{Electron}}(m_{\nu\text{Muon}} - m_{\nu\text{Electron}}) \text{ as the squared mass} \\ &\text{difference: } m_{\nu\text{Muon}}^2 - m_{\nu\text{Electron}}^2 = 2m_{\nu\text{Electron}}(m_{\nu\text{Muon}} - m_{\nu\text{Electron}}) + (m_{\nu\text{Muon}} - m_{\nu\text{Electron}})^2 \\ &\text{and for } m_{\nu\text{Muon}}^2 = m_{\nu\text{Electron}}^2 - m_{\nu\text{Higgs}}^2 = (0.002982 - 0.00271 = 0.00027) \text{ for } \nu(0.00027) = m_{\nu\text{Muon}} = 0.01643 \\ &= 5.51 m_{\nu\text{Electron}} \cdot \end{aligned}$$

$$\begin{aligned} \{m_{\nu\text{Muon}}^2 - m_{\nu\text{Electron}}^2\} - m_{\nu\text{Muon}}^2 + 2m_{\nu\text{Muon}}m_{\nu\text{Electron}} - m_{\nu\text{Electron}}^2 &= 2m_{\nu\text{Muon}}m_{\nu\text{Electron}} - 2m_{\nu\text{Electron}}^2 \\ &= 2m_{\nu\text{Electron}}\{m_{\nu\text{Muon}} - m_{\nu\text{Electron}}\} \\ &= 2m_{\nu\text{Electron}}^2\{m_{\nu\text{Muon}}/m_{\nu\text{Electron}} - 1\} = 8.892 \times 10^{-6}\{11.02-1\} = 8.910 \times 10^{-5}, \text{ approximating the KamLAND 2005} \\ &\text{neutrino mass induction value of } 7.997 \dots \times 10^{-5} \text{ eV}^2 \text{ obtained for a ratio of } 11m_{\nu\text{Electron}} = 2m_{\nu\text{Muon}}. \end{aligned}$$

For 3 (anti)neutrinos then, the cosmological summation lower and upper bounds for (anti)neutrino oscillations are:

$$0 + m_{\nu\text{electron-muon}} + m_{\nu\text{electron-tauon}} + m_{\nu\text{muon-tauon}} = 3(0.002982) = 0.00895 \text{ eV}^* \text{ or } 0.00893 \text{ eV [SI] and } 3(0.0030+0.0546) = 3(0.0576) = 0.1728 \text{ eV}^* \text{ or } 0.1724 \text{ eV [SI] respectively.}$$

Inclusion of the scalar Higgs (anti)neutrino as a fourth (anti)neutrino inertial self-state extends this upper boundary by 0.0521 eV\* and 0.0520 eV to 0.2249 eV\* or 0.2243 eV [SI].

$$\sum m_{\nu} = m_{\nu\text{Electron}} + m_{\nu\text{Muon}} + m_{\nu\text{Higgs}} + m_{\nu\text{Tauon}} = 0.002982 \dots + 0.0164 \dots + 0.0521 \dots + 0.0546 \dots = 0.1261 \text{ eV}^* \text{ or } 0.1258 \text{ eV.}$$

In terms of the Higgs Mass Induction and their inertial states, the Neutrinos are their own antiparticles and then Majorana defined; but in terms of their basic magneto charged nature within the Unified Field of Quantum Relativity, the Neutrinos are different from their Antineutrino antiparticles in their Dirac definition of  $R^2G^2B^2[+\frac{1}{2}]$  for the Antineutrinos and in  $B^2G^2R^2[-\frac{1}{2}]$  for the Neutrinos.

$mv_{\text{Higgs}} = m_e \lambda_w \cdot rE / (2\pi r_M R_e) \{1/r_G - 1/r_F\} \sim 9.3 \times 10^{-38} \text{ kg}$  or 0.052 eV for a scalar blueprint  $\text{Antiv}_{\text{Higgs}} = R^4G^4B^4[0]$  with anti-state  $v_{\text{Higgs}} = B^4G^4R^4[0]$  and coupling as the Tauon (Anti) Neutrino as

$\text{Antiv}_{\text{tauon}} = R^2G^2B^2[+\frac{1}{2}] + R^4G^4B^4[0] = R^6G^6B^6[+\frac{1}{2}] = \text{Antiv}_{\text{electron}} + \text{Antiv}_{\text{Higgs}}$   
and  $v_{\text{tauon}} = B^2G^2R^2[-\frac{1}{2}] + B^4G^4R^4[0] = B^6G^6R^6[-\frac{1}{2}] = v_{\text{electron}} + v_{\text{Higgs}}$

For a differential equation for Potential Energy:  $\nabla^2\phi - \{\mu r\}^2 = 0$

$\nabla^2\phi - \{r/R_e\}^2 = 0 = (1/r) \cdot \partial^2/\partial r^2\{r\phi\} - \{r/R_e\}^2 \cdot \phi = \{r/R_e\}^2 \cdot (r\phi)$  for a solution  $r\phi = \text{constant} \cdot \exp[-r/R_e]$  for the Yukawa Potential with  $\mu = 1/R_e = 4\pi\epsilon_0 m_e c^2 / e^2 = 4\pi m_e / \mu_0 e^2$   
 $\phi = \text{constant} \cdot (1/r) \cdot \exp[-r/R_e] \Rightarrow m_e c^2 = (\mu_0 e^2 c^2 / 4\pi R) \cdot \exp[-R/R_e]$  for  $R/R_e = \exp[-R/R_e]$

$f(R/R_e) = R/R_e - \exp[-R/R_e] = f(x) = x - \exp[-x] = 0$  with derivative  $f'(R/R_e) = f'(x) = 1 + \exp(-x)$

and  $x_{k+1} = x_k - f(x)/f'(x)$  for a Newton-Raphson solution

$x_0 = \frac{1}{2}$  for  $x_1 = \frac{1}{2} - (-0.10653066)/(1.6065307) = 0.56631100$ ;

$x_2 = 0.56631100 - (-0.00130508243)/(1.56761552) = 0.56714353$ ;

$x_3 = 0.56714353 - (0.00000037547)/(1.56714316) = 0.56714330\dots$  for  $R = 0.5671433 R_e$

For the potential energy of the electron with effective mass  $m_e = \mu_0 e^2 / 4\pi R$ , the Yukawa potential for the nucleus reduces the classical electron radius to  $0.5671433 R_e$ , which approximates the radius of the proton as  $\frac{1}{2}R_e$  but diverges from the proton's charge radius by the factor X approximately.

We have shown that the sought-after reduction of the classical radius of the electron occurs in the interval from  $A=\frac{1}{2}$  to  $A=1$  and where the Yukawa potential results in  $\frac{1}{2}XR_e$  or  $= 0.85838 \times 10^{-15} \text{ m}^*$  for the charge radius of the proton at  $A=1$  as precisely half of the reduced monopolar quantum relativistic electron radius at  $1.716761063 \times 10^{-15} \text{ m}^*$ .

The Yukawa potential applied to the classical electromagnetic electron in electro stasis so approximates the monopolar quantum relativistic electron in  $0.5671433/0.618034$  or 91.77%.

### **From the Feynman Lecture:**

This function is called the *Yukawa potential*. For an attractive force,  $K$  is a negative number whose magnitude must be adjusted to fit the experimentally observed strength of the forces. The Yukawa potential of the nuclear forces dies off more rapidly than  $1/r$  by the exponential factor.

The potential—and therefore the force—falls to zero much more rapidly than  $1/r$  for distances beyond  $1/\mu$ , as shown in Fig. 28–6. The “range” of nuclear forces is much less than the “range” of electrostatic forces. It is found experimentally that the nuclear forces do not extend beyond about  $10^{-13} \text{ cm}$ , so  $\mu \approx 10^{15} \text{ m}^{-1}$ .

$$\phi = K \frac{e^{-\mu r}}{r}. \quad (28.18)$$

This function is called the *Yukawa potential*. For an attractive force,  $K$  is a negative number whose magnitude must be adjusted to fit the experimentally observed strength of the forces.

The Yukawa potential of the nuclear forces dies off more rapidly than  $1/r$  by the exponential factor. The potential—and therefore the force—falls to zero much more rapidly than  $1/r$  for distances beyond  $1/\mu$ , as shown in Fig. 28–6. The “range” of nuclear forces is much less than the “range” of electrostatic forces. It is found experimentally that the nuclear forces do not extend beyond about  $10^{-13}$  cm, so  $\mu \approx 10^{15} \text{ m}^{-1}$ .

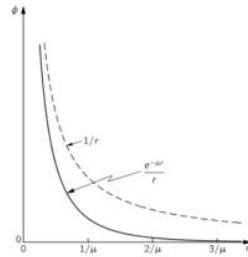

Fig. 28–6. The Yukawa potential  $e^{-\mu r}/r$ , compared with the Coulomb potential  $1/r$ .

Finally, let's look at the free-wave solution of Eq. (28.17). If we substitute

$$\phi = \phi_0 e^{i(\omega t - kx)}$$

into Eq. (28.17), we get that

$$\frac{\omega^2}{c^2} - k^2 - \mu^2 = 0.$$

Relating frequency to energy and wave number to momentum, as we did at the end of Chapter 34 of Vol. I, we get that

$$\frac{E^2}{c^2} - p^2 = \mu^2 \hbar^2,$$

which says that the Yukawa “photon” has a mass equal to  $\mu\hbar/c$ . If we use for  $\mu$  the estimate  $10^{15} \text{ m}^{-1}$ , which gives the observed range of the nuclear forces, the mass comes out to  $3 \times 10^{-25} \text{ g}$ , or 170 MeV, which is roughly the observed mass of the  $\pi$ -meson. So, by an analogy with electrodynamics, we would say that the  $\pi$ -meson is the “photon” of the nuclear force field. But now we have pushed the ideas of electrodynamics into regions where they may not really be valid—we have gone beyond electrodynamics to the problem of the nuclear forces.

Fig. 28–6. The Yukawa potential  $e^{-\mu r}/r$ , compared with the Coulomb potential  $1/r$ .

**For an open hyperbolic cosmology in 10 dimensions, changing the 'flat pi' to 'hyperbolic pi' then increases the value of 'flat pi' by so 4.9% and sets the volume proportionality equal to the Golden Ratio Phi:  $\Phi = \frac{1}{2}\{\sqrt{5} + 1\} = 1.618033...$**

$$\pi_{\text{hyperbolic}} = \frac{16}{3\Phi} = 3.29618127... = 1.0492070...\pi$$

For  $\sinh(R)/R = 1.0492070...$

$R = 0.539425...$  using Newton's Root Aproximation  $\{x_0=1\}$

and  $R = -0.539425...$  in the total curvature  $1/(iR)^2 = 1/|R|^2 = 0.290979...$

$$f(R) = \sinh(R) - 1.0492070...R = 0$$

$$f'(R) = \cosh(R) - 1.0492070...$$

Newton's Method

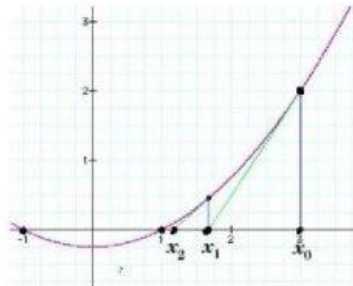

$$x_{n+1} = x_n - \frac{f(x_n)}{f'(x_n)}$$

## The Wave Matter of de Broglie: $\lambda_{\text{deBroglie}} = h/p$

View: <https://youtu.be/-lfmqyXs7z8> View: <https://youtu.be/tQSbms5MDvY>

The Wave matter of de Broglie from the Energy-Momentum Relation is applied in a (a) nonrelativistic, a (b) relativistic and a (c) superluminal form in the matter wavelength:

$$\lambda_{\text{deBroglie}} = h/p = hc/pc \text{ for } (pc) = v\{E^2 - E_0^2\} = m_0c^2 \cdot v\{[v/c]^2/(1-[v/c]^2)\}$$

(a) Example:

A pellet of 10g moves at 10 m/s for a de Broglie wavelength  $v_{\text{dB}} = h/mv = h/0.1 = 6.7 \times 10^{-33} \text{ m}^*$

This matter wavelength requires diffraction interference pattern of the order of  $\lambda_{\text{dB}}$  to be observable and subject to measurement

(b) Example:

An electron, moving at 80% of light speed 'c' requires relativistic development

$E_0 = m_0c^2$  with  $E = mc^2 = m_0c^2/\sqrt{1-[v/c]^2}$ , a 66.66% increase in the electron's energy describing the Kinetic Energy  $E - E_0 = \{m - m_0\}c^2$

for a relativistic momentum  $p = m_0c \cdot v\{[0.8]^2/(1-[0.8]^2)\} = (1.333..) m_0c = h/\lambda_{\text{deBroglie}}$  and for a relativistic de Broglie wavelength, 60% smaller, than for the non-relativistic electron in

$\lambda_{\text{deBroglie}} = h/1.333..m_0c < h/0.8m_0c = \lambda_{\text{deBroglie}} (1.83 \times 10^{-12} \text{ m relativistic and } 3.05 \times 10^{-12} \text{ m}^* \text{ non-relativistic for an electron 'Restmass' of } 9.11 \times 10^{-31} \text{ kg}^* \text{ and measurable in diffraction interference patterns with apertures comparable to this wave matter scale).}$

(c) The de Broglie matter wave speed in its 'group integrated' form derives from the postulates of Special Relativity and is defined in the invariance of light speed 'c' as a classical upper boundary for the acceleration of any mass M. In its 'phase-individuated' form, the de Broglie matter wave is 'hyper accelerated' or tachyonic, the de Broglie wave speed being lower bounded by light speed 'c'

$$v_{\text{phase}} = \text{wavelength} \cdot \text{frequency} = (h/mv_{\text{group}})(mc^2/h) = c^2/v_{\text{group}} > c \text{ for all } v_{\text{group}} < c$$

$$m = \text{Energy}/c^2 = hf/c^2 = hc/\lambda_{\text{deBroglie}}c^2 = h/\lambda_{\text{deBroglie}}c = m_{\text{deBroglie}} = [\text{Action as Charge}^2]_{\text{mod}}/c(\text{Planck-Length Oscillation}) = [e^2]_{\text{mod}}/cI_{\text{Planck}}\alpha = [e^2c^2/ce]_{\text{mod}} = [ec]_{\text{modular}}$$

as monopole mass of GUT-string IIB and as string displacement current mass equivalent for the classical electron displacement  $2R_e = e^*/c^2 = [ec]_{\text{modular}}$  as Wormhole minimum spacetime configuration for the Big Bang Instanton of Big Bang wormhole energy quantum  $E_{\text{ps}} = hf_{\text{ps}} = m_{\text{ps}}c^2 = k_B T_{\text{ps}}$  as a function of  $e^* = 1/E_{\text{ps}}$  of Heterotic superstring class HE 8x8 and relating the Classical Electron Diameter  $\{2R_e\}$  as Monopole Mass  $[ec]_{\text{mod}}$  in mass  $M = E/c^2$  modular dual in Curvature Radius  $r_{\text{ps}} = \lambda_{\text{ps}}/2\pi = 2G_0M/c^2 \Rightarrow G_0m_{\text{ps}}/c^2$  quantum gravitationally.

The factor  $2G_0/c^2$  multiplied by factor  $4\pi$  is Einstein's Constant  $\kappa = 8\pi G_0/c^2 = 3.102776531 \times 10^{-26} \text{ m/kg}$  describing how spacetime curvature relates to the mass embedded in that spacetime in the theory of General Relativity coupled to the theory of Quantum Relativity.

The self-duality of the superstring IIB aka the Magnetic Monopole self-state in GUT Unification  $2R_e/30[ec]_{\text{mod}} = 2R_e c^2/30[ec^3]_{\text{mod}} = e^*/30[ec^3]_{\text{mod}} \propto \kappa$  for a proportionality constant  $\{\kappa^*\} = 2R_e/30\kappa[ec]_{\text{mod}} = 2R_e \cdot c^2/8\pi e = e^*/8\pi e = 1.2384.. \times 10^{20} \text{ kg}^*/\text{m}^*$  in string units for Star Charge in Star Coulomb  $C^*/\text{Electro Charge in Coulomb C unified}$ .

The monopolar Grand Unification (SEWG  $\Rightarrow$  sEwG  $\Rightarrow$  gravitational decoupling SEW.G) has a Planck string energy reduced at the IIB string level of  $e^*=[ec^3]_{\text{modular}}$  for  $m_{ps}c^2/[ec]_{\text{modular}} = [c^3]_{\text{modular}} = 2.7 \times 10^{25} \text{ eV}^*$  or  $4.3362 \times 10^6 \text{ J}^*$  for a monopole mass  $[ec]_{\text{modular}} = m_{\text{monopole}} = 4.818 \times 10^{-11} \text{ kg}^*$ .

Mass  $M = n \cdot m_{ss} = \Sigma m_{ss} = n \cdot \{h/2\pi r_{\text{deBroglie}C}\} \cdot [E_{ss} \cdot e^*]_{\text{mod}} = n \cdot m_{ps} \cdot [E_{ss} \cdot \{9 \times 10^{60}\} \cdot 2\pi^2 R_{\text{rmp}}^3]_{\text{mod}}$   
 $= n \cdot m_{ps} \cdot [E_{ss} \cdot \{2R_e \cdot c^2\}]_{\text{mod}} = n \cdot [E_{ps} \cdot E_{ss}]_{\text{mod}} \cdot [2R_e]_{\text{mod}}$  for  $\lambda_{\text{deBroglie}} = \lambda_{ps} = h/m_{ps}c$  and  $[E_{ps} \cdot e^*]_{\text{mod}} = 1$   
 $\{2R_e c^2\} = 4G_o M_{\text{Hyper}}$  for the classical electron radius  $R_e = k_e e^2 / m_e c^2$  and describes its Hyper-Mass  
 $M_{\text{Hyper-electron}} = R_e c^2 / 2G_o = k_e e^2 / 2G_o m_e = 1.125 \times 10^{12} \text{ kg}^*$  for an effective electron mass of  
 $m_e = k_e e^2 / 2G_o (1.125 \times 10^{12}) = 9.290527148 \times 10^{-31} \text{ kg}^*$  in string units and where  
 $k_e = 1/4\pi\epsilon_o = [G_o]_u = [30c]_u = 9 \times 10^9 \text{ (Nm}^2/\text{C}^2)^*$ .

The curvature radius for the electron mass  $m_e = r_{\text{electron}} c^2 / 2G_o$  then becomes  $r_{\text{electron}} = 2G_o m_e / c^2$   
 $= 2.293957 \dots \times 10^{-57} \text{ m}^*$  in string-membrane inflaton space as  $1.44133588 \times 10^{-34} r_{ps}$  in the wormhole instanton space.

$R_e / r_{\text{inflaton-electron}} = M_{\text{Hyper-electron}} / m_e = 1.2109108 \dots \times 10^{42} = \frac{1}{2} (EMI/GI) = \frac{1}{2} (e^2 / G_o^2 m_e^2) = \frac{1}{2} \{e / G_o m_e\}^2$   
 $= \frac{1}{2} (2.421821677 \times 10^{42})$  for the classical electron radius  $R_e$  halved from the classical electron diameter  $2R_e$   
from the definition for the modulated supermembrane coupled in  $E_{ps} E_{ss} = h^2$  and  $E_{ps} / E_{ss} = f_{ps}^2 = 1 / f_{ss}^2$ .

Mass  $M = n \cdot m_{ss} = \Sigma m_{ss} = n \cdot \{m_{ps}\} \cdot [E_{ss} \cdot e^*]_{\text{mod}} = n \cdot \{m_{ps}\} \cdot \{hf_{ss}\} \cdot 2\pi^2 R_{\text{rmp}}^3]_{\text{mod}} = n \cdot [m_{ps} f_{ss}^2]_{\text{mod}} = n \cdot [hf_{ss} / c^2] = n \cdot m_{ss}$

The classical approach described in the Feynman lecture derives the momentum of a moving electron in deriving the volume element for electromagnetic momentum  $p = m_{\text{electromagnetic}} \cdot v = m_{\text{emr}} \cdot v$  with the component of the electron's motion  $v$  parallel  $g \sin \theta$  and a relativistic velocity  $v_{\text{rel}} = v \gamma = v / \sqrt{1 - [v/c]^2}$  modifying  $p_{\text{rel}} = p \gamma$

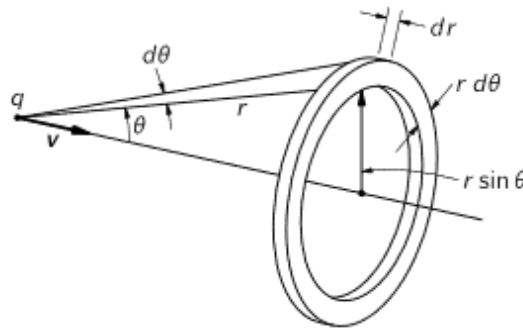
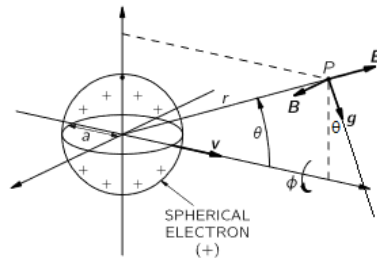

Fig. 28–2. The volume element  $2\pi r^2 \sin \theta d\theta dr$  used for calculating the field momentum.



**B perpendicular E and v**  
**g sinθ in direction of v**  
**g cosθ transverse direction of v**

Fig. 28-1. The fields **E** and **B** and the momentum density **g** for a positive electron. For a negative electron, **E** and **B** are reversed but **g** is not.

For magnetic field  $B = vxE/c^2 = v.E.\sin\theta/c^2$  the momentum density  $\epsilon_0 E \times B = \epsilon_0 v.E^2 \sin\theta/c^2$  electric energy density  $U_e = \frac{1}{2}\epsilon_0 E^2$  and  $E = q/(4\pi\epsilon_0 r^2)$  and  $dV = 2\pi r^2.\sin\theta.d\theta.dr$  for the spacetime interval from some minimum boundary  $a$  to  $\infty$  and with  $\int 1/r^2 dr = |-1/r|[\infty, a] = 0 + 1/a = 1/a$  for  $a=R_e$  for the waded particle electron

$$p = \int \epsilon_0 v (E \sin\theta/c)^2 dV = p_{rel} = \{2\pi\epsilon_0 v \gamma/c^2\} \{q^2/16\pi^2\epsilon_0^2\} \int r^{-2} \cdot \{\sin^3 \theta.d\theta\}.dr = \{v\gamma q^2/8\pi\epsilon_0 c^2\} \int r^{-2} \cdot \{\sin^3 \theta.d\theta\}.dr$$

$$= \{v\gamma q^2/8\pi.a.\epsilon_0 c^2\} \int \sin^3 \theta.d\theta = \{v\gamma q^2/8\pi.a.\epsilon_0 c^2\} \int \{1-\cos^2\theta\} \sin\theta.d\theta$$

$$= \{v\gamma q^2/8\pi.a.\epsilon_0 c^2\} \left| \frac{1}{3}\cos^3\theta - \cos\theta \right| [\pi, 0] = \{v\gamma q^2/8\pi.a.\epsilon_0 c^2\} \left| -\frac{1}{3} + 1 - \frac{1}{3} + 1 \right| = v\gamma q^2/6\pi.a.\epsilon_0 c^2 = \mu_0 v \gamma e^2/6\pi.R_e$$

**$p_{rel} = \mu_0 v \gamma e^2/6\pi.R_e$  for  $m_{emr} = \mu_0 \gamma e^2/6\pi.R_e = \{4/3\}\frac{1}{2}m_e = \frac{2}{3}m_e > \frac{1}{2}m_e$**

The electromagnetic mass must however be exactly  $U_e/c^2$  by the postulates of Relativity and so the classical derivation must be modified in the particle nature of the electron in its associated quantum mechanical nature.

Using  $m_{emr} = m_o = m_e/2A = \mu_0 \gamma e^2/6\pi.R_e = \{4/3\}\frac{1}{2}m_e = \frac{2}{3}m_e$  defines  $A = \frac{3}{4}$  in the  $(v/c)^2$  distribution and for a velocity:

$$B^2 = \{v/c\}^2 = -\frac{5}{6} \pm \sqrt{(19/12)}$$

for roots  $x=0.425$  and  $y=-2.092$ ; with  $v_{electron} = 0.65189908 c$  in

$$U_m = (\frac{1}{2}v^2)\mu_0 e^2/4\pi R_e = \frac{1}{2}m_e v^2$$

$$\{4/3\}.U_e/c^2 = \{4/3\}\gamma e^2/8\pi.\epsilon_0 R_e c^2 = \{4/3\}\frac{1}{2}m_e = \{4/3\}.U_m/c^2 = \{4/3\}.\mu_0 \gamma e^2/8\pi.R_e = \{4/3\}\gamma k e^2/e^*$$

$$= \{4/3\}\gamma k e^2.hf^* = (1-\frac{1}{3})m_e \text{ for an apparent Restmass } \frac{2}{3}m_e.$$

The corresponding energy level for this mass increase of  $\frac{1}{3}m_e$  for a velocity of  $0.745 c$  is  $2.788 \times 10^{-14}$  Joules\* or  $0.17350 \text{ MeV}^*$  ( $0.17307 \text{ MeV}$ ) for a dynamic mass  $m_e$ .

The classical electromagnetic mass  $m_{emr}$  becomes quantum mechanical in the string-brane sourcesink energy  $E^*$ -Gauge photon quantum of the Quantum Big Bang Weylian wormhole. In particular setting the classical electron radius at  $(3/2)R_e = \alpha h/(2\pi c.\frac{2}{3}m_e) = \alpha h/2\pi c m_e = 4.1666 \times 10^{-15} \text{ m}^*$  ( $4.15971430 \times 10^{-15} \text{ m}$ ) normalizes the  $\{4/3\}$  factor from the classical derivation of the electromagnetic mass for the electron in the mean value for the  $A = \frac{1}{2}$  to  $A=1$  interval for the  $B^2$  distribution.

$$E^* = E_{ps} = hf_{ps} = hc/\lambda_{ps} = m_{ps}c^2 = (m_e/2e).\sqrt{[2\pi G_o/\alpha hc]} = \{m_e/m_p\}/\{2e v \alpha\} = 1/2R_e c^2 = 1/e^* \text{ [Eq.XII-12]}$$

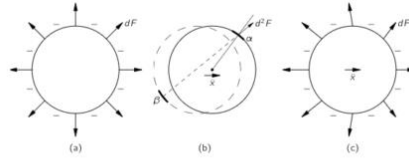

Fig. 28-3. The self-force on an accelerating electron is not zero because of the retardation. (By  $dF$  we mean the force on a surface element  $da$ , by  $d^2F$  we mean the force on the surface element  $da_\alpha$  from the charge on the surface element  $da_\beta$ .

The picture is something like this. We can think of the electron as a charged sphere. When it is at rest, each piece of charge repels electrically each other piece, but the forces all balance in pairs, so that there is no *net* force. [See Fig. 28-3(a).] However, when the electron is being accelerated, the forces will no longer be in balance because of the fact that the electromagnetic influences take time to go from one piece to another. For instance, the force on the piece  $\alpha$  in Fig. 28-3(b) from a piece  $\beta$  on the opposite side depends on the position of  $\beta$  at an earlier time, as shown. Both the magnitude and direction of the force depend on the motion of the charge. If the charge is accelerating, the forces on various parts of the electron might be as shown in Fig. 28-3(c). When all these forces are added up, they don't cancel out. They would cancel for a uniform velocity, even though it looks at first glance as though the retardation would give an unbalanced force even for a uniform velocity. But it turns out that there is no net force unless the electron is being accelerated. With acceleration, if we look at the forces between the various parts of the electron, action and reaction are not exactly equal, and the electron exerts a force *on itself* that tries to hold back the acceleration. It holds itself back by its own bootstraps.

It is possible, but difficult, to calculate this self-reaction force; however, we don't want to go into such an elaborate calculation here. We will tell you what the result is for the special case of relatively uncomplicated motion in one dimension, say  $x$ . Then, the self-force can be written in a series. The first term in the series depends on the acceleration  $\ddot{x}$ , the next term is proportional to  $\dot{x}$ , and so on.<sup>1</sup> The result is

$$F = \alpha \frac{e^2}{ac^2} \ddot{x} - \frac{2}{3} \frac{e^2}{c^3} \dot{x} + \gamma \frac{e^2 a}{c^4} \dot{x} + \dots, \quad (28.9)$$

where  $\alpha$  and  $\gamma$  are numerical coefficients of the order of 1. The coefficient  $\alpha$  of the  $\ddot{x}$  term depends on what charge distribution is assumed; if the charge is distributed uniformly on a sphere, then  $\alpha = 2/3$ . So there is a term, proportional to the acceleration, which varies inversely as the radius  $a$  of the electron and agrees exactly with the value we got in Eq. (28.4) for  $m_{\text{elec}}$ . If the charge distribution is chosen to be different, so that  $\alpha$  is changed, the fraction  $2/3$  in Eq. (28.4) would be changed in the same way. The term in  $\dot{x}$  is *independent* of the assumed radius  $a$ , and also of the assumed distribution of the charge; its coefficient is *always*  $2/3$ . The next term is proportional to the radius  $a$ , and its coefficient  $\gamma$  depends on the charge distribution. You will notice that if we let the electron radius  $a$  go to zero, the last term (and all higher terms) will go to zero; the second term remains constant, but the first term—the electromagnetic mass—goes to infinity. And we can see that the infinity arises because of the force of one part of the electron on another—because we have allowed what is perhaps a silly thing, the possibility of the "point" electron acting on itself.

Expressing the electromagnetic mass in a series perturbation expansion in decreasing the classical electron size so sets a minimum size for the electron at the Weyl boundary or 'Planck-Stoney Bounce' limit at  $R_e$  in  $\chi/c^2 = \lambda_{ps}/2\pi$  for  $\chi = r_{ps}c^2 = 2G_0M_{\text{Hubble}} = \text{Wormhole Radius of the Instanton of the quantum gravitational Big Bang creation event}$ .

Modular duality  $E_{ps} = hf_{ps} = 1/e^* = \text{Energy primary sourcesink quantum as the Weyl wormhole energy then transforms the electron's self- energy in a decomposition or fine structure of the classical electron radius and as 'spacetime awareness' or 'physical consciousness'}$ .

Spacetime awareness  $|df/dt|$  acting on a volume of space in a holographic Weyl Bound conformally maps and integrates the quantum gravitational wormhole of wavelength  $\lambda_{ps} = 10^{-22} \text{ m}^*$  onto the classical electron radius as:  $R_{\text{wormhole}}/R_{\text{electron}} = 360/(2\pi \cdot 10^{10})$ .

This can be defined as a form of angular acceleration  $|\alpha\omega = \alpha\dot{\omega}| = |df/dt|_e = e^*/V^* = \lambda_{ps}/hc \cdot V^*$  acting on space time volumars or multi-dimensional branes in particle-wave interactions of elementary particles-wavicles.

It is so the space occupied and containing dynamical interactions, which render the synthesis of classical physics with quantum mechanics possible; the underpinning nature for those interactions being based on the quantum geometry of the conformal transformations from and to the higher dimensional and open-closed Anti de Sitter (AdS) spacetimes intersecting the lower dimensional and closed de Sitter (dS) spacetimes. {Closed 10D dS - Open AdS 11D Mirror – Closed 12D dS}

$$m_{\text{emr}} = \mu_0 \gamma e^2 / 6\pi \cdot R_e = \{4/3\} \cdot U_e / c^2 = \{4/3\} \gamma e^2 / 8\pi \cdot \epsilon_0 R_e c^2 = \{4/3\} \frac{1}{2} m_e = \{4/3\} \cdot U_m / c^2 = \{4/3\} \cdot \mu_0 \gamma e^2 / 8\pi \cdot R_e = \{4/3\} \gamma k_e e^2 / e^* = \{4/3\} \gamma k_e e^2 \cdot hf^*$$

As the electromagnetic mass must however be exactly  $U_e/c^2$  by the postulates of Relativity and so the classical derivation must be modified in the particle nature of the electron in its associated quantum mechanical nature.

A Self-Interaction for the electron in the jerk or time derivative of acceleration  $d^3x/dt^3$  is naturally found in the definition of the classical size of the electron in the wormhole quantization.



The self-interaction of the electron then can be considered as a deformation of the size of the electron using both the classical scale of the particular and the quantum mechanical form in the nature of its intrinsic quantum spin in the form of an angular acceleration given as the time derivative of frequency  $df/dt$ .

The extension of Newton's Law in relativistic momentum and energy leads to  $dp_{rel}/dt = d(m_o\gamma v)/dt = m_o d(\gamma v)/dt + \gamma v d(m_o)/dt = m_o d(\gamma v)/dt + \{\gamma v h/c^2\} df/dt = m_o \gamma^3 .dv/dt + \{\gamma v h/c^2\} df/dt$ .

It then is the dynamical interaction of the electron with spacetime itself, that changes the classical volume of the electron as a function of  $df/dt$  in the membrane space of  $2R_e c^2 = \text{Volume} \times \text{Angular radially independent acceleration}$ .

Using this electron self-interaction as a conformal mapping from the Quantum Big Bang 'singularity' from the electric charge in brane bulk space as a magnetic charge onto the classical spacetime of Minkowskian and from the Planck parameters onto the atomic-nuclear diameters in  $2R_e c^2 = e^*$  from the Planck length conformally maps the Planck scale onto the classical electron scale as the classical electron radius and as defined in the alpha electromagnetic fine structure and the related mass-charge definition for the eigen energy of the electron in  $m_e c^2 = k_e e^2 / R_e$ .

The pre-Big Bang 'bounce' of many models in cosmology can be found in a direct link to the Planck-Stoney scale of the 'Grand-Unification-Theories'. In particular it can be shown, that the Square root of Alpha, the electromagnetic fine structure constant, multiplied by the Planck-length results in a Stoney-transformation factor  $L_p \sqrt{\alpha} = e/c^2$  in a unitary coupling between the quantum gravitational and electromagnetic fine structures.

$G_o k_e = 1$  for  $G_o = 4\pi \epsilon_o$  and representing a conformal mapping of the Planck length onto the scale of the 'classical electron' in superposing the lower dimensional inertia coupled electric charge quantum 'e' onto a higher dimensional quantum gravitational-D-brane magnetopole coupled magnetic charge quantum 'e\*' =  $2R_e . c^2 = 1/hf_{ps} = 1/E_{Weyl \text{ wormhole}}$  by the application of the mirror/T duality of the super membrane  $E_{ps} E_{ss}$  of heterotic string class HE(8x8).

Also in a model of quantum relativity (QR), there is a quantization of exactly  $10^{10}$  wormhole 'singularity-bounce' radii defining the radian-trigonometric Pi ratio as  $R_{\text{wormhole}}/R_{\text{electron}} = 360/2\pi . 10^{10}$  or  $10^{10} = \{360/2\pi\} \{R_e/r_{\text{wormhole}}\}$  as a characteristic number of microtubules in a conformal mapping from the classical electron space onto the 'consciousness' space of the neuron-cell intermediate between the Hubble scale of  $10^{26}$  m and the Planck scale of  $10^{-35}$  m as geometric mean of  $10^{-4}$  to  $10^{-5}$  meters.

It is so the geometry of the architecture of the microtubules and the nature of their construction utilizing the pentagonal quasi-crystalline pattern in its application for maximizing the compression of information in the Fibonacci geometrical pattern-sequencing.

This then results in the conformal mapping of this geometry as a quantum geometry and defining physical consciousness as a conformal mapping of the quantum of spacetime in the form of Weylian 'Quantum Big Bang' wormholes of the cosmogenesis.

<https://cosmosdawn.net/index.php/en...he-weyl-curvature-hypothesis-of-roger-penrose>

The 4/3 factor from the classically derived electromagnetic mass appears in the quantum geometry of the subatomic particles, namely in the different quark content for the positively charged proton and the electrically overall neutral neutron, both displaying an internal charge distribution however.

For the Proton, one adds one (K-IR-Transition energy) and subtracts the electron-mass for the d-quark level and for the Neutron one doubles this to reflect the up-down-quark differential.

An electron perturbation subtracts one  $2-2/3=4/3$  electron energy as the difference between 2 leptonic rings from the proton's 2 up-quarks and  $2-1/3=5/3$  electron energy from the neutron's singular up-quark to relate the trisected nucleonic quark geometric template. This is revisited below.

Proton  $m_p = u.d.u = K.KIR.K = (939.776 + 1.5013 - 0.5205 - 0.1735) \text{ MeV}^* = 940.5833 \text{ MeV}^* (938.270 \text{ MeV})$ .  
 Neutron  $m_n = d.u.d = KIR.K.KIR = (939.776 + 3.0026 - 1.0410 + 0.1735) \text{ MeV}^* = 941.9111 \text{ MeV}^* (939.594 \text{ MeV})$ .

This is the ground state from the Higgs-Restmass-Induction-Mechanism and reflects the quarkian geometry as being responsible for the inertial mass differential between the two elementary nucleons. All ground state elementary particle masses are computed from the Higgs-Scale and then become subject to various fine structures.

But modular string duality defines the Inverse Energy of the wormhole as the quantum of physical consciousness in units of the product of the classical electron diameter and the proportionality between energy and mass in the Maxwell constant  $c^2 = 1/\epsilon_0\mu_0$  and the inverse of the product between electric permittivity  $\epsilon_0 = 1/120c\pi$  and magnetic permeability  $\mu_0 = 120\pi/c$  for 'free space' impedance:

$Z_0 = \text{electric field strength } E / \text{magnetic field strength } H = \sqrt{(\mu_0/\epsilon_0)} = c\mu_0 = 1/c\epsilon_0 = 120\pi\}$ .

**Coulomb Electro-Charge  $e = L_p \cdot \sqrt{\alpha} \cdot c^2 \leftrightarrow 2R_e \cdot c^2 = e^*$  (Star Coulomb Magneto-Charge)**

$e^* = 2R_e c^2 = 2k_e e^2 / m_e = e^2 / 2\pi\epsilon_0 m_e = \alpha hc / \pi m_e$  with Alpha-Variation  $(1.6021119 \times 10^{-19} / 1.60217662 \times 10^{-19})^2 = 0.99991921...$  for the calibration

$$\begin{aligned} \{R_e m_e\} &= \mu_0 e^2 / 4\pi = (2.8179403267 \times 10^{-15} \text{ m})(9.10938356 \times 10^{-31} \text{ kg}) \\ &= (2.818054177 \times 10^{-15} \text{ m})(9.109015537 \times 10^{-31} \text{ kg}) = (10^{-7})(1.60217662 \times 10^{-19} \text{ C})^2 \\ &= [2.56696992 \times 10^{-45}] \cdot [1.001671358][1.003753127] \cdot (0.99991921...) \text{ (mkg)}^* \\ &= [2.56696992 \times 10^{-45}] \cdot [1.002711702]^2 \cdot [0.99991921...] = 2.580701985 \times 10^{-45} \text{ {mkg}}^* \\ &= (2.77777... \times 10^{-15} \text{ m}^*) (9.290527148 \times 10^{-31} \text{ kg}^*) = \mu_0 e^2 / 4\pi \text{ for } e = 1.606456344 \times 10^{-19} \text{ C}^* \end{aligned}$$

for the quantum mechanical electron and adjusted in the [SI/\*] alpha variation [mkg/C<sup>2</sup>]  
 = Alpha Variation  $\alpha_{var}$  in  $\{R_e m_e \cdot \alpha_{var}\}_{SI} = \{\alpha_{var} \cdot \mu_0 e^2 / 4\pi\}_{SI} = \{R_e m_e\}^* = \{\mu_0 e^2 / 4\pi\}^*$ .

Decreasing the electronic charge quantum from  $1.60217662 \times 10^{-19} \text{ C}$  to  $1.602111893 \times 10^{-19} \text{ C}$  so calibrates the SI-unitary measurement system with the star based \* unitary mensuration system in the alpha variation in a reduced classical electron radius of  $R_e = 2.773142866 \times 10^{-15} \text{ m}$  for an increased electron effective Restmass of  $m_e = 9.255789006 \times 10^{-31} \text{ kg}$  or for  $(R_e m_e) = (\mu_0 e^2 / 4\pi) = 2.566762525 \times 10^{-45} \text{ mkg}$ .

**From Wikipedia:** <https://en.wikipedia.org/wiki/Electron>

The electron has no known [substructure](#).<sup>[1][75]</sup> and it is assumed to be a [point particle](#) with a [point charge](#) and no spatial extent.<sup>[9]</sup> In [classical physics](#), the angular momentum and magnetic moment of an object depend upon its physical dimensions. Hence, the concept of a dimensionless electron possessing these properties contrasts to experimental observations in Penning traps which point to finite non-zero radius of the electron. A possible explanation of this paradoxical situation is given below in the "[Virtual particles](#)" subsection by taking into consideration the [Foldy-Wouthuysen transformation](#).

The issue of the radius of the electron is a challenging problem of the modern theoretical physics. The admission of the hypothesis of a finite radius of the electron is incompatible to the premises of the theory of relativity. On the other hand, a point-like electron (zero radius) generates serious mathematical difficulties due to the [self-energy](#) of the electron tending to infinity.<sup>[76]</sup> These aspects have been analyzed in detail by [Dmitri Ivanenko](#) and [Arseny Sokolov](#).

Observation of a single electron in a [Penning trap](#) shows the upper limit of the particle's radius is  $10^{-22}$  meters.<sup>[77]</sup> Also an upper bound of electron radius of  $10^{-18}$  meters<sup>[78]</sup> can be derived using the [uncertainty relation](#) in energy.

There *is* also a physical constant called the "[classical electron radius](#)", with the much larger value of  $2.8179 \times 10^{-15}$  m, greater than the radius of the proton. However, the terminology comes from a simplistic calculation that ignores the effects of [quantum mechanics](#); in reality, the so-called classical electron radius has little to do with the true fundamental structure of the electron.<sup>[79][note 5]</sup>

Note that the defined maximum scale for the electron in the Penning Trap is consistent with the defined size of the wormhole radius  $r_{ps} = 10^{-22} / 2\pi$  meters as minimum spacetime configuration of the Instanton. The 'point particular' electron of Quantum Electrodynamics' and its point-like particle fields, so crystallizes naturally from the theory of the string-membrane classes. The classical electron radius  $R_e$  has much to do with the quantum mechanical electron addressed by Richard Feynman in the linked lecture.

#### **From the Feynman Lecture:**

There is, however, one fundamental objection to this theory and to all the other theories we have described. All particles we know obey the laws of quantum mechanics, so a quantum-mechanical modification of electrodynamics has to be made.

Light behaves like photons. It is not 100 percent like the Maxwell theory. So, the electrodynamic theory has to be changed. We have already mentioned that it might be a waste of time to work so hard to straighten out the classical theory, because it could turn out that in quantum electrodynamics the difficulties will disappear or may be resolved in some other fashion. But the difficulties do not disappear in quantum electrodynamics.

That is one of the reasons that people have spent so much effort trying to straighten out the classical difficulties, hoping that if they *could* straighten out the classical difficulty and *then* make the quantum modifications, everything would be straightened out. The Maxwell theory still has the difficulties after the quantum mechanics modifications are made.

The quantum effects do make some changes—the formula for the mass is modified, and Planck's constant  $h/2\pi$  appears—but the answer still comes out infinite unless you cut off an integration somehow—just as we had to stop the classical integrals at  $r=a$ . And the answers depend on how you stop the integrals.

We cannot, unfortunately, demonstrate for you here that the difficulties are really basically the same, because we have developed so little of the theory of quantum mechanics and even less of quantum electrodynamics. So, you must just take our word that the quantized theory of Maxwell's electrodynamics gives an infinite mass for a point electron.

It turns out, however, that nobody has ever succeeded in making a *self-consistent* quantum theory out of any of the modified theories. Born and Infeld's ideas have never been satisfactorily made into a quantum theory. The theories with the advanced and retarded waves of Dirac, or of Wheeler and Feynman, have never been made into a satisfactory quantum theory. The theory of Bopp has never been made into a satisfactory quantum theory. So today, there is no known solution to this problem.

We do not know how to make a consistent theory—including the quantum mechanics—which does not produce an infinity for the self-energy of an electron, or any point charge. And at the same time, there is no satisfactory theory that describes a non-point charge. It is an unsolved problem.

In case you are deciding to rush off to make a theory in which the action of an electron on itself is completely removed, so that electromagnetic mass is no longer meaningful, and then to make a quantum theory of it, you should be warned that you are certain to be in trouble. There is definite experimental evidence of the existence of electromagnetic inertia—there is evidence that some of the mass of charged particles is electromagnetic in origin.

It used to be said in the older books that since Nature will obviously not present us with two particles—one neutral and the other charged, but otherwise the same—we will never be able to tell how much of the mass is electromagnetic and how much is mechanical. But it turns out that Nature *has* been kind enough to present us with just such objects, so that by comparing the observed mass of the charged one with the observed mass of the neutral one, we can tell whether there is any electromagnetic mass. For example, there are the neutrons and protons. They interact with tremendous forces—the nuclear forces—whose origin is unknown. However, as we have already described, the nuclear forces have one remarkable property. As far as they are concerned, the neutron and proton are exactly the same.

The *nuclear* forces between neutron and neutron, neutron and proton, and proton and proton are all identical as far as we can tell. Only the little electromagnetic forces are different; electrically the proton and neutron are as different as night and day. This is just what we wanted. There are two particles, identical from the point of view of the strong interactions, but different electrically. And they have a small difference in mass.

The mass difference between the proton and the neutron—expressed as the difference in the rest-energy  $mc^2$  in units of MeV—is about 1.3 MeV, which is about 2.6 times the electron mass. The classical theory would then predict a radius of about  $\frac{1}{2}$  to  $\frac{1}{3}$  the classical electron radius, or about  $10^{-13}$  cm. Of course, one should really use the quantum theory, but by some strange accident, all the constants— $2\pi's$  and  $h/2\pi's$ , etc.—come out so that the quantum theory gives roughly the same radius as the classical theory.

The only trouble is that the *sign* is wrong! The neutron is *heavier* than the proton.

Nature has also given us several other pairs—or triplets—of particles which appear to be exactly the same except for their electrical charge. They interact with protons and neutrons, through the so-called “strong” interactions of the nuclear forces. In such interactions, the particles of a given kind—say the  $\pi$ -mesons—behave in every way like one object *except* for their electrical charge.

In Table [28-1](#) we give a list of such particles, together with their measured masses. The charged  $\pi$ -mesons—positive or negative—have a mass of 136.9 MeV, but the neutral  $\pi^0$ -meson is 4.6 MeV lighter. We believe that this mass difference is electromagnetic; it would correspond to a particle radius of 3 to  $4 \times 10^{-14}$  cm. You will see from the table that the mass differences of the other particles are usually of the same general size.

**Table 28-1 Particle Masses**

Particle	Charge (electronic)	Mass (MeV)	$\Delta m^1$ (MeV)
n (neutron)	0	939.5	
p (proton)	+1	938.2	-1.3
$\pi$ ( $\pi$ -meson)	0	135.0	
	$\pm 1$	139.6	+4.6
K (K-meson)	0	497.8	
	$\pm 1$	493.9	-3.9
$\Sigma$ (sigma)	0	1191.5	
	+1	1189.4	-2.1
	-1	1196.0	+4.5

$^1\Delta m = (\text{mass of charged}) - (\text{mass of neutral})$ .

Now the size of these particles can be determined by other methods, for instance by the diameters they appear to have in high-energy collisions. So, the electromagnetic mass seems to be in general agreement with electromagnetic theory, if we stop our integrals of the field energy at the same radius obtained by these other methods. That is why we believe that the differences do represent electromagnetic mass. You are no doubt worried about the different signs of the mass differences in the table. It is easy to see why the charged ones should be heavier than the neutral ones.

But what about those pairs like the proton and the neutron, where the measured mass comes out the other way? Well, it turns out that these particles are complicated, and the computation of the electromagnetic mass must be more elaborate for them.

For instance, although the neutron has no *net* charge, it *does* have a charge distribution inside it—it is only the *net* charge that is zero. In fact, we believe that the neutron looks—at least sometimes—like a proton with a negative  $\pi$ -meson in a “cloud” around it, as shown in Fig. 28–5.

Although the neutron is “neutral,” because its total charge is zero, there are still electromagnetic energies (for example, it has a magnetic moment), so it is not easy to tell the sign of the electromagnetic mass difference without a detailed theory of the internal structure.

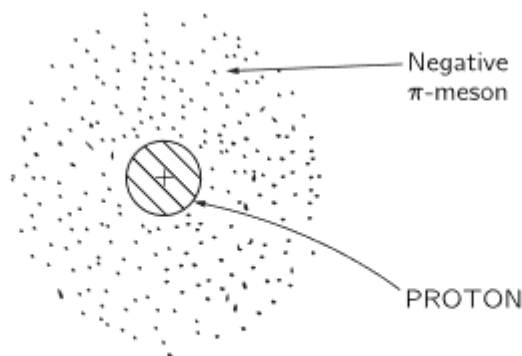

Fig. 28–5. A neutron may exist, at times, as a proton surrounded by a negative  $\pi$ -meson.

The negatively charged pion cloud of Feynman and Yukawa can be substituted by the inner negatively charged mesonic Inner Ring in the quantum geometry of the quarks based on colour charged or chromodynamic double charged kernels surrounded by an Inner Mesonic and an outer Leptonic Ring wave structure asymptotically confined by a magneto charged region known as the classical radius of the electron. The rings are oppositely charged to the kernel quarks. They however remain coupled in the kernel trisection say as the protons  $udu=K.KIR.K=K(K+IR)K$  or the neutron's  $dud=KIR.K.KIR=(IR+K)K(K+IR)$  except when they experience the electro-weak decays.

## The Mass Distribution for a Quantum Relativistic Classical Electron

We set Constant A in  $Am_{ec} = \mu_0 e^2 / 8\pi c R_e$  for  $A\beta^2 = 1/\sqrt{1-\beta^2} - 1$   
 from:  $c^2(m - m_{ec}) = \mu_0 e^2 v^2 / 8\pi R_e = m_{ec} c^2 (1/\sqrt{1-\beta^2} - 1) = m_{ec} v^2 A$  with a total QR monopolar mass  
 $m = m_{ec} / \sqrt{1-(v/c)^2}$

This leads to a quadratic in  $\beta^2$ :  $1 = (1 + A\beta^2)^2(1-\beta^2) = 1 + \beta^2(2A + A^2\beta^2 - 2A\beta^2 - A^2\beta^4 - 1)$  and so:  
 $\{A^2\beta^4 + \{2A - A^2\}\beta^2 + \{1 - 2A\}\} = 0$  with solution in roots:

$$\beta^2 = \frac{[A-2] \pm \sqrt{[A^2+4A]}}{2A} = \left\{ \left\{ \frac{1}{2} - \frac{1}{A} \right\} \pm \sqrt{\left\{ \frac{1}{4} + \frac{1}{A} \right\}} \right\} \dots\dots\dots [\text{Eq.XII-13}]$$

and  $A = -\{1 \pm 1/\sqrt{1-\beta^2}\}/\beta^2$  solving (in 4 roots) the quadratic  $(2A\beta^2 + 2 - A)^2 = A^2 + 4A$

This defines a distribution of  $\beta^2 = (v/c)^2$  and  $\beta = v/c$  velocity ratios in  $m_{ec} A \beta^2 = \mu_0 e^2 [v/c]^2 / 8\pi R_e$

The electromagnetic mass  $m_{ec}$  in the relation  $m_{ec} A = \frac{1}{2} m_e$  is then the monopolar quantum relativistic Restmass and allows correlation by the Compton constant and between its internal magnetopolar self-interaction with its external magnetic relativistic and kinetic effective electron ground state mass  $m_e$ , respectively.

In particular  $m_e = 2A m_{ec}$  and is  $m_{ec}$  for  $A = \frac{1}{2}$  as the new minimization condition. In string parameters and with  $m_e$  in \*units,  $m_e A = 30 e^2 c / e^* = \frac{1}{2} m_e = 4.645263574 \times 10^{-31} \text{ kg}^*$

In terms of the superstring quantum physical theory, the expression  $[ec]_{\text{unified}} = 4.81936903 \times 10^{-11} \text{ kg}^*$  or  $[ec^3]_u = 2.7 \times 10^{16} \text{ GeV}^*$  as the Grand-Unification (GUT) energy scale of the magnetic monopole, which represents the first superstring class transformation from the Planck-string class I of closure to the self-dual opening of class IIB, as the magnetic monopole of the inflaton epoch.

$$E^* = E_{\text{weyl}} = E_{\text{ps}} = h f_{\text{ps}} = hc / \lambda_{\text{ps}} = m_{\text{ps}} c^2 = (m_e / 2e) \cdot v [2\pi G_o / \alpha hc] = \{m_e / m_p\} / \{2e v \alpha\} = 1 / 2 R_e c^2 = 1 / e^*$$

**Monopolar charge quantum as Electropolar charge quantum**  
 $e^* / c^2 = 2R_e \Leftarrow \text{super-membrane displacement transformation} \Rightarrow v \alpha \cdot l_{\text{planck}} = e / c^2$

This implies that for  $A=1$ ,  $m_{ec} = \frac{1}{2} m_e$ , where  $m_e = 9.290527155 \times 10^{-31} \text{ kg}^*$  from particular algorithmic associations of the QR cosmogony and is related to the fine structure of the magnetic permeability constant  $\mu_0 = 120\pi / c = 1 / \epsilon_0 c^2$ , defining the classical electronic radius.

As  $\beta \geq 0$  for all velocities  $v$ , bounded as group speed in  $c$  for which  $\beta^2 = \beta = 1$ , (and not de Broglie phase speed:

$$v_{\text{dB}} = (h / m v_{\text{group}}) (m c^2 / h) = c^2 / v_{\text{group}} > c$$
; a natural limit for the  $\beta$  distribution is found at  $A = \frac{1}{2}$  and  $A = \infty$ .

The electron's Restmass  $m_{ec}$  so is binomially distributed for the  $\beta$  quadratic. Its minimum value is half its effective mass  $m_e$  and as given in:

$$\mu_0 e^2 / 8\pi m_e R_e = \frac{1}{2} m_e$$
 for a distributed rest-mass  $m_{ec} / R_e = m_e / r_{ec}$  in A and

$$m_{\text{electric}} = k_e q^2 / 2R_e c^2 = \mu_0 e^2 / 8\pi R_e = U_e / c^2 = \frac{1}{2} m_e$$
 for  $A = \frac{1}{2}$  and its maximum for  $A = \infty$  is the unity  $v=c$  for  $\beta=1$

The classical Restmass  $m_o$  of the electron and as a function of its velocity from  $v=0$  to  $v=c$  so is itself distributed in its magnetic mass potential about its effective Restmass  $m_e = \mu_o e^2 / 4\pi R_e c^2$  and as a function of the classical electron radius  $R_e$ .

Its minimum condition is defined by the electric potential energy in  $m_o = \frac{1}{2} m_e$  for  $A = \frac{1}{2}$  with effective Restmass  $m_e$  being the Restmass for a stationary electron  $v=0$  without magnetic inertia component.

For  $v=c$ , the mass of the electron incorporates a purely relativistic and quantum relative self-interacting magnetic monopolar value for which  $m_o=0$  and the effective  $m_e$  assumes the minimum rest energy for the electron at  $A=1$  and generalised as  $m_e = 2A m_o$ .

The classical Restmass  $m_o = hf/c^2$  so decreases from its maximum value as  $m_o = m_e$  to  $m_o = 0$  as a function of the velocity distribution and in the extension of the classical force to incorporate the differential

$d(m_o) = hd(f)/c^2$  by  $F_{\text{Newton}} = F_a + F_\alpha = F\text{-acceleration} + F\text{-alpha}$  as the sum of the classical Newtonian linear momentum change and the quantum mechanical angular acceleration momentum change in the self-interaction for the electron.

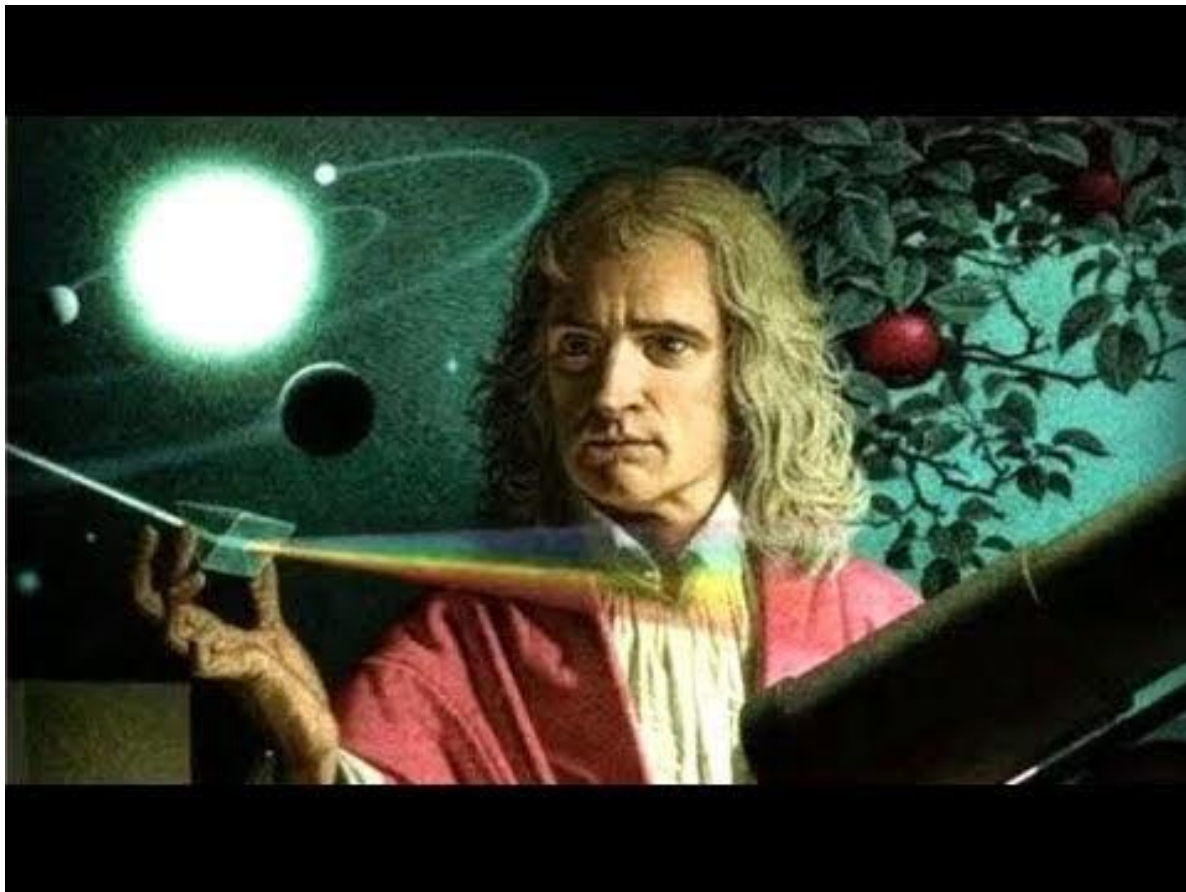



# Derivation of the electron restmass from a super-membraned Planck Oscillator

The bare electron mass  $m_{e0}$  should be found in two intervals defined in the alpha variation applied to both a complex halving part  $A_3$  upper bound -  $A_3$  lower bound for a minimised  $\delta_{min}$  added to  $\frac{1}{2}\alpha_{var}$  and a real halving part  $A_6$  lower bound -  $A_6$  upper bound for a maximised  $\delta_{max}$  subtracted from  $\frac{1}{2}\alpha_{var}$ .

To calibrate the(\*)-measurement system to the SI-mensuration units within the context of the alpha variation, the electromagnetic charge-mass ratio for the electron is used with:

$\{e/m_{e0} = 1.606456344 \times 10^{-19} \text{ C}^*/9.143202823 \times 10^{-31} \text{ kg}^* = 1.756995196 \times 10^{11} \text{ C}^*/\text{kg}^*\}$  and  
 $\{e/m_{e0} = 1.602111894 \times 10^{-19} \text{ C}/9.10901554 \times 10^{-31} \text{ kg} = 1.758820024 \times 10^{11} \text{ C}/\text{kg}\}$  minimised in the alpha variation maximum.

$A_0 = 0.000000000$		$(1/0^+)m_e \cdot (0^+)R_e$
$A_{1b} = 0.487459961..$	$\frac{1}{2} E_{ps}  =  1/2e^*  =  1/4R_e c^2  =  \frac{1}{2}hf_0  =  \frac{1}{2}E_0 $ for conformal mapping of minimum energy Planck Oscillator $E_0 \leftrightarrow E_{ps}$	
$A_1 = 0.488459961..$	$\frac{1}{2}\alpha_{var}$	
$A_3 = 0.488500361..$	$\alpha_{var}$	
$A_u = 0.488540761..$	alpha variation $\alpha_{var}$	
$A_5 = 0.489123658..$	$\{\sqrt{\alpha}\}^3$	$\Delta\{\frac{1}{2}\alpha_{var}\}$ Minimum = $2 \times 10^{-6}$
$A_{5u} = 0.489164058..$	$\{\sqrt{\alpha}\}^3$	$m_{e0} = m_e \sqrt{\{1 - (i\beta)^2\}}$ complex solution
	$\frac{1}{2}\alpha_{var}$	$A_{SI} = A_{3lb} + \Delta\{\frac{1}{2}\alpha_{var}\}_{min}$
	$\frac{1}{3}\alpha^{2/3} - \alpha_{var} - \frac{1}{2} E_{ps}  - \{\sqrt{\alpha}\}^3$	0.488500361.. +0.000002000 0.488502361.. -0.000000095 0.488502266
$A_{1/2} = 0.500000000$	$\frac{1}{3}\alpha^{2/3} - \alpha_{var} - \frac{1}{2} E_{ps} $	$\delta m_{e0}$ complex - real uncertainty solution $\delta m_{e0} = 9.5 \times 10^{-8}$
	$\frac{1}{2}\alpha_{var}$	$(1)m_e \cdot (1)R_e$
$A_4 = 0.511459239..$	$\frac{1}{2}\alpha_{var}$	
$A_u = 0.511499639..$	$\alpha_{var}$	
$A_2 = 0.511540039..$	alpha variation $\alpha_{var}$	
$A_6 = 0.512082536..$	$\{\sqrt{\alpha}\}^3$	real solution
$A_u = 0.512122936..$	$\{\sqrt{\alpha}\}^3$	$m_{e0} = m_e \sqrt{\{1 - \beta^2\}}$
$A_{ub} = 0.512540039..$	$\frac{1}{2}\alpha_{var}$	$\Delta\{\frac{1}{2}\alpha_{var}\}$ Maximum = $6 \times 10^{-6}$
	$\frac{1}{2} E_{ps}  =  \frac{1}{2}E_0 $	$A_{SI} = A_{6ub} - \Delta\{\frac{1}{2}\alpha_{var}\}_{max}$
$A_{3/5} = 0.600000000..$	Volume Charge for the classical electron for $U_e = \frac{3}{5} \mu_0 e^2 / 4\pi R_e \neq \mu_0 e^2 / 8\pi R_e = \frac{1}{2} m_e c^2 = U_e$	
$A_{3/4} = 0.750000000$	Surface Charge for the classical electron for $U_e = \mu_0 e^2 / 6\pi R_e \neq \mu_0 e^2 / 8\pi R_e = \frac{1}{2} m_e c^2 = U_e$	
	As $\beta^2 = (1 - (m_e/m_{ec})^2)$ and $(1 - (m_{e0}/m_e)^2)$ as a distribution of mass ratios, it can be linked to the Compton constant in $m_e/m_{ec} = r_{ec}/R_e$ in an inverse proportionality and so the unitary interval and the electron's mass and spacial extent distribution.	
	A conformal mapping of the minimum Planck energy as a Planck oscillator $E_0 = \frac{1}{2}hf_0$ at the Planck energy of superstring class I onto the heterotic superstring HE(8x8) in the qbb energy quantum $E_{ps} = E_{weyl}$ associates and couples the unitary interval to the displacement bounce of the inflaton. We denote the $E_{ps}$ energy quantum as $ E_{ps} $ in its unified modular self state where $E_{ps} \cdot e^* = 1 = E^*e^*$	
	The alpha variation $\alpha_{var} = 1 - (1.6021119 \times 10^{-19} / 1.60217662 \times 10^{-19})^2 = 1 - 0.99999192 = 8.08 \times 10^{-5}$ by [Eq.10]	
$A_{1/4} = 1.000000000$	$A_{ub} - A_4 = A_{3u} - A_{1b} = 0.0010808... = 0.0010 + 0.00008078 = \frac{1}{2} E_{ps}  + [-]\alpha_{var}$	
		$(1/2)m_e \cdot (2)R_e$

Minimum Planck Oscillator $\frac{1}{2} E_0  \leftrightarrow  E_{ps} ^* = 1/ e^* $	$\frac{1}{2} E_{ps} $	$\frac{3}{4} E_{ps} $	$1 E_{ps} $	$5/4 E_{ps} $	$3/2 E_{ps} $
Value in energy (Joules; Joules*)	1/1000	1/666 $\frac{2}{3}$	1/500	1/400	1/333 $\frac{1}{3}$
Value as modulated to A-interval as M-Sigma	$1 \times 10^{-3}$	$1.5 \times 10^{-3}$	$2 \times 10^{-3}$	$2.5 \times 10^{-3}$	$3 \times 10^{-3}$
$ E_{ps} ^*/ e^* $ to reunite-renormalize $E^*e^*=1$	$2 \times 10^{-6}$	$3 \times 10^{-6}$	$4 \times 10^{-6}$	$5 \times 10^{-6}$	$6 \times 10^{-6}$
$\frac{3}{5}$ -value in partition interval $\frac{3}{5}m_e \cdot \frac{3}{5}R_e$ for mean $A=3/4$	1/2	3/4	1	5/4	3/2
Fraction of Renormalization effect	1/3	1/2	2/3	5/6	1
Value of $\Delta\{\frac{1}{2}\alpha_{var}\}$ in $A_{6lb} - A_{6ub}$ and in $A_{3ub} - A_{3lb}$	$2 \times 10^{-6}$	$3 \times 10^{-6}$	$4 \times 10^{-6}$	$5 \times 10^{-6}$	$6 \times 10^{-6}$
	complex min				real max
The $\frac{1}{2}\alpha_{var}$ sub-interval so is adjusted by $6 \times 10^{-6}$ from $A_{6ub} - \Delta\{\frac{1}{2}\alpha_{var}\} = A_{SI}$ for $m_{e0}SI$ for the real solution					

# Electromagnetic Mass Distribution for the Quantum Relativistic Electrodynamic Electron

$A = \mu_0 e^2 / 8\pi m_e R_e$ $= ke^2 / 2m_e R_e c^2$ $= ke^2 / m_e c^2$ $= ke^2  E_{ps}^*  / m_e c$	$B^2 = 1 - (m_{eo} / m_e)^2$ $= 1 - (m_{eo} R_e / m_e c r_{ec})^2$ $B^2 \Rightarrow (i\beta)^2$ for $A < 1/2$	x root	y root	self-relative-QR- $m_{eo}$ $m_{eo} \text{ kg}^* / m_e \text{ kg}$ $m_{eo} = m_e v(1 - \beta^2)$ $= m_e / \gamma$ $B^2 \Rightarrow (i\beta)^2$ for $A < 1/2$	v/c	$(v_{ps}/c)^2 = 1 / (1 + r_{ec}^4 / 4\pi^2 \alpha^2 r_{ps}^4)$ for magnetopolar.velocity.in c (m/s)* $r_{ec} = R_e / \gamma = v(1 - \beta^2) R_e$ $r_{ec} / R_e = m_e / m_{eo}$ in $m^*$	self-relative -QR- $r_e$
0	$0 \neq 0$	$1/0^*$	$-1/0^*$	$[1/0^*] m_e$	$i/0^*$	algorithmic metaphysicality inflaton spacetime as complex $v_{ps} = ic = ci$	$[\infty] R_e$
$1 - 1/2\sqrt{2} = 0.292893218$		$-1 = i^2$ x-root is complex	$1 + 1/2\sqrt{2} = -4.82842714$ y-root is complex	0 0	i	1 c 1 0 0 $R_e$	$(2/0^*) R_e$
$\{1 - 1/2\sqrt{2}\} + O(10^{-17}) = 0.292893218^+$ $- \{1 \pm 1/\sqrt{1 - \beta^2}\} / \beta^2$ $\sim -1 \{1 \pm 1 + 1/2\beta^2\} / \beta^2$	$\beta_{\text{compleximage}}^2 = -2.914213561 \dots$ $\pm 1.91421356200 \dots$	$-0.9999999999 \dots$ $\{i m_e / (am_{pe})\}^2 = -1 + 3.282806345 \times 10^{-17}$	$-4.82842714^+$	$0^+$ $0^+$	i	$v_{ps} = 2\pi\alpha c / \sqrt{1 + 4\pi^2 \alpha^2}$ $= 0.045798805 ic$ $13,739,641.79 \text{ [m/s]}^*$ $r_{ec} = r_{ps} = 180 R_e / (\pi 10^{10})$ $1.591549431 \times 10^{-23}$ $5.729577953 \times 10^{-9} R_e$	$349,065,850.6 R_e$
$A_{0b} = 0.487459961$	$B_{0b}^2 = -1.55145054$ $\pm 1.517053242$	-0.034397297	-3.068503782	$9.129344446 \times 10^{-31}$ $9.095208981 \times 10^{-31}$	0.185i	$1.558679858 \times 10^{-18} ic$ $4.676039573 \times 10^{-10}$ $2.729585632 \times 10^{-15}$ $0.982650855 R_e$	$1.018 R_e$
$A_1 = 0.488459961$	$B_1^2 = -1.547250706 \pm 1.515668402$	-0.031582303	-3.062919108	$9.142642017 \times 10^{-31}$ $9.108456831 \times 10^{-31}$	0.177i	$1.554149091 \times 10^{-18} ic$ $4.662447273 \times 10^{-10}$ $2.733561478 \times 10^{-15}$ $0.984082159 R_e$	$1.016 R_e$
$A_{31} = 0.488500361$	$B_{31}^2 = -1.547081394$ $\pm 1.515612547$	-0.031468847	-3.062693941	$9.143177565 \times 10^{-31}$ $9.108990376 \times 10^{-31}$	0.177i	$1.55396695 \times 10^{-18} ic$ $4.661900851 \times 10^{-10}$ $2.733721674 \times 10^{-15}$ $0.984139803 R_e$	$1.016 R_e$
$A_{31} = \text{complex}$ $0.488502266$ $[e/m] = 1.758820024$ $\times 10^{-11} \text{ C/kg}$ with $\alpha_{var}$ A-root complex=real	$B_{31}^2 = -1.54707341$ $\pm 1.515609914$	-0.031463495	-3.062683324	$9.14320282 \times 10^{-31}$ $9.109015537 \times 10^{-31}$ $\delta m_{eo} = 9.5 \times 10^{-8}$ uncertainty solution complex - real	0.177i	$1.553958288 \times 10^{-18} ic$ $4.661874865 \times 10^{-10}$ $2.733729293 \times 10^{-15}$ $0.984142545 R_e$	$1.016 R_e$
$A_{31} = \text{complex}$ $0.488502361$ $[e/m] = 1.758820024$ $\times 10^{-11} \text{ C/kg}$ with $\alpha_{var}$ min	$B_{31}^2 = -1.547073013$ $\pm 1.515609783$	-0.03146323	-3.062682796	$9.143204074 \times 10^{-31}$ $9.109016786 \times 10^{-31}$	0.177i	$1.553957936 \times 10^{-18} ic$ $4.661873808 \times 10^{-10}$ $2.733729603 \times 10^{-15}$ $0.984142657 R_e$	$1.016 R_e$

$A_{3u} =$ 0.488540761	$B_{3u}^2 =$ -1.54691211 $\pm 1.5155567$	-0.03135541	-3.06246881	9.143712983x10 <sup>-31</sup> 9.109523792x10 <sup>-31</sup>	0.177i	1.553784965x10 <sup>-18</sup> ic 4.661354894x10 <sup>-10</sup> 2.733881762x10 <sup>-15</sup> 0.984197434 R <sub>e</sub>	1.016 R <sub>e</sub>
$A_{51} =$ 0.489123658	$B_{51}^2 =$ -1.54447277 $\pm 1.514751719$	-0.029721051	-3.059224489	9.151423661x10 <sup>-31</sup> 9.117205639x10 <sup>-31</sup>	0.172i	1.551167736x10 <sup>-18</sup> ic 4.653503207x10 <sup>-10</sup> 2.73618718x10 <sup>-15</sup> 0.985027384 R <sub>e</sub>	1.015 R <sub>e</sub>
$A_{5u} =$ 0.489164058	$B_{5u}^2 =$ -1.544303917 $\pm 1.514695982$	-0.029607935	-3.058999899	9.151957085x10 <sup>-31</sup> 9.117737069x10 <sup>-31</sup>	0.172i	1.550986921x10 <sup>-18</sup> ic 4.652960762x10 <sup>-10</sup> 2.736346668x10 <sup>-15</sup> 0.9850848 R <sub>e</sub>	1.015 R <sub>e</sub>
$\frac{1}{2}$	<b>-3/2 ± 3/2</b>	<b>0.0</b>	<b>-3</b>	<b>m<sub>ee</sub> = m<sub>e</sub> = m<sub>ec</sub></b> 9.290527148x10 <sup>-31</sup> 9.255789006x10 <sup>-31</sup>	<b>0</b>	<b>1.5050654x10<sup>-18</sup> c</b> <b>2.777777...x10<sup>-15</sup></b> <b>= 1.00 R<sub>e</sub></b>	<b>R<sub>e</sub></b>
0.50078795	$B_{realmag}^2 =$ -1.496853158 $\pm 1.498950686$	0.002097530539 0.00209752801	-2.995803844	9.280778463x10 <sup>-31</sup> 9.246076772x10 <sup>-31</sup>	0.0458	1.508228953x10 <sup>-18</sup> c 4.524686858x10 <sup>-10</sup> 2.774863014x10 <sup>-15</sup> 0.998950685 R <sub>e</sub>	1.001576 R <sub>e</sub>
$A_{41} =$ 0.511459239	$B_{41}^2 =$ -1.455190021 $\pm 1.484988222$	0.029798201	-2.940178243	9.151059822x10 <sup>-31</sup> 9.1163843161x10 <sup>-31</sup>	0.173	1.551286282x10 <sup>-18</sup> c 2.73608263x10 <sup>-15</sup> = 0.98498975 R <sub>e</sub>	1.015 R <sub>e</sub>
$A_{4u} =$ 0.511499639	$B_{4u}^2 =$ -1.455035593 $\pm 1.484936225$	0.029900632	-2.939971818	9.15057674x10 <sup>-31</sup> 9.116361885x10 <sup>-31</sup>	0.173	1.55145488x10 <sup>-18</sup> c 2.73593396x10 <sup>-15</sup> = 0.98493623 R <sub>e</sub>	1.015 R <sub>e</sub>
$A_2 =$ 0.511540039	$B_2^2 =$ -1.45488119 $\pm 1.484884234$	0.030003044	-2.939765424	9.150093721x10 <sup>-31</sup> 9.115880672x10 <sup>-31</sup>	0.1732.86	1.55161873x10 <sup>-18</sup> c 2.7357895x10 <sup>-15</sup> = 0.98488423 R <sub>e</sub>	1.015 R <sub>e</sub>
$A_{41} =$ 0.512082536	$B_{41}^2 =$ -1.452810201 $\pm 1.484186714$	0.031376513	-2.936996915	9.143613382x10 <sup>-31</sup> 9.109424564x10 <sup>-31</sup>	0.177	1.553818818x10 <sup>-18</sup> c 2.73385198x10 <sup>-15</sup> = 0.98418671 R <sub>e</sub>	1.016 R <sub>e</sub>
$A_{51} =$ real 0.512116936 [e/m]= 1.758820024 x10 <sup>-11</sup> C/kg with $\alpha_{var}$ max	$B_{51}^2 =$ -1.452679026 $\pm 1.484142522$	0.031463496	-2.936821548	[1.02/1.02]m <sub>e</sub> √(1-x) 9.14320282x10 <sup>-31</sup> 9.109015537x10 <sup>-31</sup>	0.177	1.553958371x10 <sup>-18</sup> c 2.73372922x10 <sup>-15</sup> = 0.98414252 R <sub>e</sub>	1.016 R <sub>e</sub>
$A_{6u} =$ 0.512122936	$B_{6u}^2 =$ -1.452656072 $\pm 1.484134815$	0.031478742	-2.936790887	9.143130852x10 <sup>-31</sup> 9.108943838x10 <sup>-31</sup>	0.177	1.553982826x10 <sup>-18</sup> c 2.73370771x10 <sup>-15</sup> = 0.98413478 R <sub>e</sub>	1.016 R <sub>e</sub>
$A_{ub} =$ 0.512540039	$B_{ub}^2 =$ -1.451067085 $\pm 1.483599368$	0.032532283	-2.934666453	9.138156632x10 <sup>-31</sup> 9.103988218x10 <sup>-31</sup>	0.180	1.555675057x10 <sup>-18</sup> c 2.73222047x10 <sup>-15</sup> = 0.98359937 R <sub>e</sub>	1.017 R <sub>e</sub>

$4(\frac{1}{2}\sqrt{3}-1)$ 0.618802153	$-1.116025404$ $\pm 1.366025404$ $-\frac{1}{4}(1+2\sqrt{3}) \pm \frac{1}{2}\sqrt{(4+2\sqrt{3})}$	$\frac{1}{4}$	$-2.4820500808$ $-(\frac{1}{4}+\sqrt{3})$	$[1.24/1.24]m_e\sqrt{(1-x)}$ $8.045832525x10^{-31}$ $8.015748411x10^{-31}$	0.500	$2.006753867x10^{-18} c$ $v_{ps} = 6.020261601x10^{-9}$ $2.405626121x10^{-15}$ $= 0.866025403 R_e$	1.238 $R_e$
$\frac{3}{4}$ Mean: $\frac{1}{2}\{\frac{1}{2}+1\}$ $\Sigma$ surface charge	$-\frac{3}{4} \pm \sqrt{(19/12)}$	0.424972405	-2.09164	$[\frac{3}{2}]m_e\sqrt{(1-x)}$ $7.045060062x10^{-31}$ $7.018717929x10^{-31}$	0.652	$2.617379438x10^{-18} c$ $v_{ps} = 7.852138314x10^{-9}$ $2.10640483x10^{-15}$ $= 0.75830574 R_e$	$3R_e/2$
$\frac{5}{6}$ $\Sigma$ Volume charge	$-7/10 \pm \sqrt{(29/20)}$	0.504159457	-1.904159458	$[\frac{5}{3}]m_e\sqrt{(1-x)}$ $6.542012566x10^{-31}$ $6.517551374x10^{-31}$	0.710	$3.035381866x10^{-18} c$ $v_{ps} = 9.106145598x10^{-10}$ $1.9559985x10^{-15}$ $= 0.70415946 R_e$	$5R_e/3$
<b>1</b>	$-\frac{1}{2} \pm \frac{1}{2}\sqrt{(5)}$	<b>0.618033988</b>	<b>-1.618033988</b>	$[2]m_e\sqrt{(1-x)}$ <b>5.741861551x10<sup>-31</sup></b> <b>5.720392198x10<sup>-31</sup></b>	<b>0.786</b>	<b>3.94031237x10<sup>-18} c</sup></b> <b><math>v_{ps} = 1.182093711x10^{-9}</math></b> <b>1.71676108x10<sup>-15</sup></b> <b>= 0.61803399 R<sub>e</sub></b>	<b>2 R<sub>e</sub></b>
$1+\frac{1}{2}\sqrt{2} =$ <b>1.707106781</b>		<b>0.828427125</b> x-root is real	<b>-1 = i<sup>2</sup></b> y-root is complex	$[3.41/3.41]m_e\sqrt{(1-x)}$ <b>3.848262343x10<sup>-31</sup></b> <b>3.833873334x10<sup>-31</sup></b>	<b>0.910</b>	<b>8.77216401x10<sup>-18} c</sup></b> <b>2.631649203x10<sup>-9</sup></b> <b>1.150593228x10<sup>-15</sup></b> <b>0.414213562 R<sub>e</sub></b> <b>= <math>(\sqrt{2} - 1) R_e</math></b>	<b>3.414213562 R<sub>e</sub></b> <b>= <math>(2+\sqrt{2}) R_e</math></b>
2	$0 \pm \frac{1}{2}\sqrt{(3)}$	0.866025403	-0.866025403	$[4]m_e\sqrt{(1-x)}$ $3.400568951x10^{-31}$ $3.387853908x10^{-31}$	0.931	$1.123396092x10^{-17} c$ $3.370188275x10^{-9}$ $1.01673724x10^{-15}$ $= 0.36602540 R_e$	4 $R_e$
<b>2.47213603</b>	<b>0.095491515 ± 0.809016986</b>	<b>0.904508501</b>	<b>-0.7135255471</b>	$[4.94/4.94]m_e\sqrt{(1-x)}$ <b>2.870930718x10<sup>-31</sup></b> <b>2.860196042x10<sup>-31</sup></b>	<b>0.951</b>	<b>1.576125021x10<sup>-17} c</sup></b> <b>4.728375064x10<sup>-9</sup></b> <b><math>R_{proton} = 0.85838052x10^{-15}</math></b> <b>= 0.309016987 R<sub>e</sub></b>	<b>4.94427206 R<sub>e</sub></b>
3	$\frac{1}{4} \pm \sqrt{(7/12)}$	0.930429282	-0.597195949	$[6]m_e\sqrt{(1-x)}$ $2.450493743x10^{-31}$ $2.44133112x10^{-31}$	0.965	$2.163360455x10^{-17} c$ $6.490081364x10^{-9}$ $7.32673935x10^{-16}$ $= 0.26376262 R_e$	6 $R_e$
4	$\frac{1}{4} \pm \sqrt{(1/2)}$	0.957106781	-0.457106781	$[8]m_e\sqrt{(1-x)}$ $1.924131173x10^{-31}$ $1.916936668x10^{-31}$	0.978	$3.50886558x10^{-17} c$ $1.052659674x10^{-8}$ $5.75296616x10^{-16}$ $= 0.20710678 R_e$	8 $R_e$
<b>174,532,925.3</b> <b><math>-\{1 \pm 1/\sqrt{[1-B^2]}\} / B^2</math></b> <b><math>\sim -1\{1 \pm 1/2B^2\} / B^2</math></b>	<b>0.499999...4 ±</b> <b>0.500000...5</b> <b><math>\sim \frac{1}{2} \pm \frac{1}{2}^+</math></b>	<b>0.999999999....</b> <b><math>\{m_e/am_{ps}\}^2 =</math></b> <b><math>1-3.282806345x10^{-17}</math></b>	<b>-0.000000...1</b>	<b><math>[\#\#\#]m_e\sqrt{(1-x)}</math></b> <b>5.323079946x10<sup>-39</sup></b> <b>5.303176457x10<sup>-39</sup></b> <b>minimum mass</b> <b>(electron-neutrino)</b> <b>0.00297104794 eV<sup>+</sup></b> <b><math>m_{ve} = m_{v^2}</math></b> <b>= 0.002982...eV<sup>+</sup></b>	<b>0.999</b>	<b>qbb boundary of physicality</b> <b>0.045798805 c</b> <b>13,739,641.79</b> <b><math>v_{ec} = \Gamma_{ps} = (m_e/am_{ps})R_e</math></b> <b>1.59154943x10<sup>-23</sup></b> <b>= 5.7296x10<sup>-9} R<sub>e</sub></sup></b>	<b>349,065,850.6 R<sub>e</sub></b>
$\infty$	$\frac{1}{2} \pm \frac{1}{2}^+$	1 <sup>-</sup>	0 <sup>-</sup>	$[\infty]0^+m_e\sqrt{(1-x)}=m_e$ $m_{ee}=0^+$	1 <sup>-</sup>	<b>algorithmic metaphysicality</b> <b>inflaton spacetime as complex</b> $v_{ps} = ic = ci$	$[\infty] R_e$

The X-root is always positive in an interval from 0 to 1 and the Y-root is always negative in the interval from -3 to 0.

for  $A=\infty$ :  $\beta^2 = \frac{1}{2} \pm \frac{1}{2} +$  for roots  $x=1$  and  $y=0$ ; for  $v=c$  with  $U_m = (\frac{1}{2}v^2)\mu_0 e^2 / 8\pi R_e$   
 $= (\frac{1}{2}v^2)\mu_0 e^2 / 4\pi R_e = \frac{1}{2}m_e c^2 = m_{magnetic}c^2 = m_{electric}c^2$  and  $m_o = 0m_e$   
 $A\beta^2 = ([1-\beta^2]^{-\frac{1}{2}} - 1) = 1 + \frac{1}{2}\beta^2 - 3\beta^4/8 + 5\beta^6/16 - 35\beta^8/128 + \dots - 1$

The Binomial Identity gives the limit of  $A=\frac{1}{2}$  in:  $A=\frac{1}{2} - \beta^2\{3/8 - 5\beta^2/16 + 35\beta^4/128 - \dots\}$  and as the non-relativistic low velocity approximation of  $E=mc^2$  as  $KE=\frac{1}{2}m_o v^2$ .

Letting  $\beta^2=n$ , we obtain the Feynman-Summation or Path-Integral for dimensionless cycle time  $n = H_o t = ct/R_{Hubble}$  with  $H_o=dn/dt$  in the UfoQR for  $1 = (1-\beta^2)(1+\beta^2)^2$  as  $\beta^4 + \beta^2 - 1 = 0$  for  $T(n) = n(n+1) = 1$ .

750-84 = 666 for 3 1/2 Times in 7 Times as 1500-168 = 1332      168x15 = 2520 = 1260+1260 = 7x360 = 7 Times = 3 1/2 Times + 3 1/2 Times

$\sum_{n=1}^{36} n = 666$       2030 = 750+20+490+20+750 = Continuity of 7 Times  
 $\{750-84\} + \frac{1}{2}\{490\} + 20 + 1260/15 + 1260/15 + 20 + \frac{1}{2}\{490\} + \{750-84\}$   
**666+245+20+2520/15+20+245+666**       $\sum_{n=prime}^7 n^2 = 666$   
 $\{1+2+3+\dots+34+35+36\} = 666$        $\{4+9+25+49+121+169+289\} = 666$



VICARIUS FILII DEI

V = 5	F = 0	D = 500
I = 1	I = 1	E = 0
C = 100	L = 50	I = 1
A = 0	I = 1	<hr/> 501
R = 0	I = 1	
I = 1	<hr/> 53	
U = 5		
S = 0		
<hr/> 112		

666



the Beast + in The Name Of Allah in Revelation 137 Dr. Chuck Meeler

Here is wisdom. Let him that hath understanding count the number of the beast: for it is the number of a man; and his number is Six hundred threescore and six. Revelation 13:18

*sophia* sophia wisdom, broad and full of intelligence; used of the knowledge of very diverse matters  
*psophizo* psephizo to count, reckon, decide by voting  
*arithmos* arithmos a definite number; an indefinite number, a multitude

P47 Late 3d c manuscript Clyde Beatty collection: Revelation 13:18 Number of the Beast

666

Byzantine Text

[http://www.csntm.org/manuscript/zoomify/GA\\_P47?image=P47\\_007a\\_k.jpg&page=3](http://www.csntm.org/manuscript/zoomify/GA_P47?image=P47_007a_k.jpg&page=3)

1 Kings 10:14 - King James Version (KJV)  
 14 And the weight of gold that came to Solomon in one year was six hundred threescore and six talents of gold.

Crossed Swords and Bimillah of Islam

John of Patmos script

From the unification polynomial  $U(x) = x^4 + 2x^3 - x^2 - 2x + 1 = 0$  and derivative  $U'(x) = 4x^3 + 6x^2 - 2x - 2$  with minimum roots at  $x_1 = X$  and  $x_2 = -(X+1) = Y$  and maximum root at  $x_3 = \frac{1}{2}$  we form the factor distribution  $(1-X)(X)(1+X)(2+X) = 0$  and form a unification proportionality:

**SNI:EMI:WNI:GI = [Strong Nuclear Interaction #]:[Electromagnetic Interaction #<sup>3</sup>]  
:[Weak Interaction #<sup>18</sup>]:[Gravitational Interaction #<sup>54</sup>]  
under the Grand Unification transformation of  $X \leftrightarrow \alpha$**

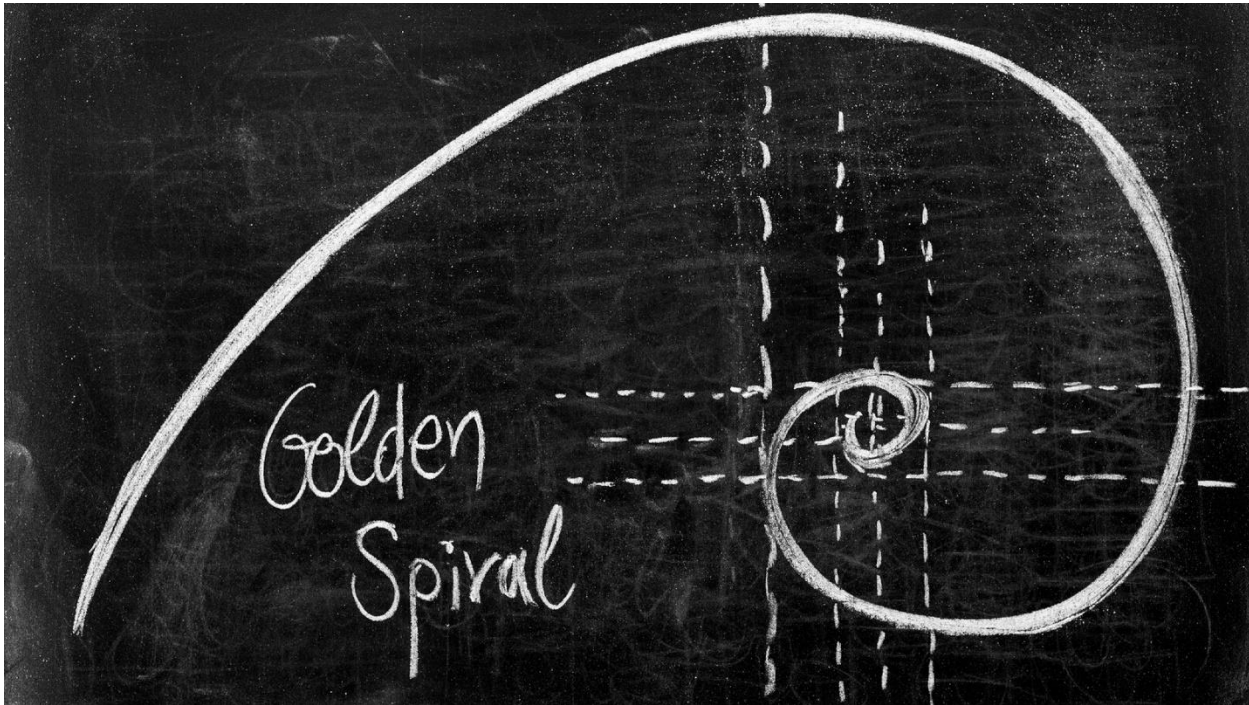

FIBONACCI NUMBERS  
Golden Spiral

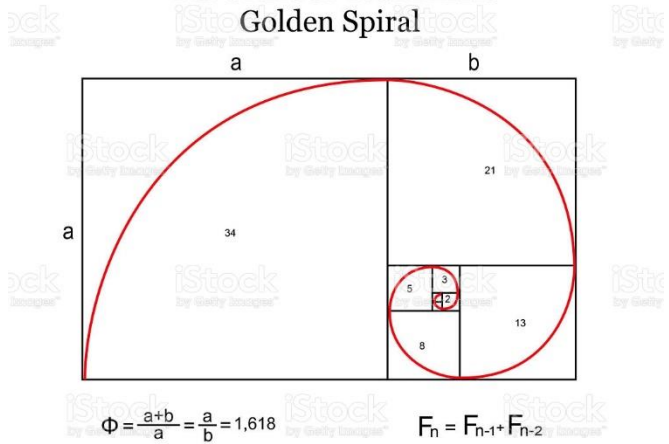

<https://youtu.be/O2wU-HT7FiM>

**X ⇔ α in N(Transformation)**

$$\{\mathbf{N}\}^3 : \mathbf{X} \rightarrow \alpha\{\#\}^3 \rightarrow \# \rightarrow \#^3 \rightarrow (\#^2)^3 \rightarrow \{(\#^2)^3\}^3 \dots \text{[Eq.XII-14]}$$

This redefines the Interaction proportion as:

SNI:EMI:WNI:GI = [#]:[#^3]:[#^18]:[#^54] = [1-X]:[X]:[1+X]:[2+X] for the X Alpha Unification, which is of course indicated in the unitary interval from A = 0 to A =1 in the β<sup>2</sup> distribution for the electron mass.

SNI:EMI	[1-X]:[X]	X	X	#:# <sup>3</sup> # <sup>2</sup>	α <sup>-2/3</sup> 1/√[3]{α <sup>2</sup> }	Invariant Upper Bound	X-Boson
SNI:WNI	[1-X]:[1+X]	[2X-1]	X <sup>3</sup>	#:# <sup>18</sup> # <sup>17</sup>	α <sup>-1/3(17)</sup> 1/√[3]{α <sup>17</sup> }		
SNI:GI	[1-X]:[2+X]	[1-X] <sup>2</sup>	X <sup>4</sup>	#:# <sup>54</sup> # <sup>53</sup>	α <sup>-1/3(53)</sup> 1/√[3]{α <sup>53</sup> }		
EMI:WNI	[X]:[1+X]	[1-X]	X <sup>2</sup>	# <sup>3</sup> :# <sup>18</sup> # <sup>15</sup>	α <sup>-5</sup> 1/√[3]{α <sup>15</sup> }		
EMI:GI	[X]:[2+X]	[2X-1]	X <sup>3</sup>	# <sup>3</sup> :# <sup>54</sup> # <sup>51</sup>	α <sup>-17</sup> 1/√[3]{α <sup>51</sup> }		
WNI:GI	[1+X]:[2+X]		X	# <sup>18</sup> :# <sup>54</sup> # <sup>36</sup>	α <sup>-12</sup> 1/√[3]{α <sup>36</sup> }	Invariant Lower Bound	L-Boson

For the unitary interval at A=½ the Compton constant defines m<sub>e</sub>.R<sub>e</sub>, but at A=1, the constancy becomes ½m<sub>e</sub>.2R<sub>e</sub> and at the average value at A=¾ it is ⅓m<sub>e</sub>.(3/2)R<sub>e</sub>.

This crystallizes the multiplying (4/3) factor calculated from the integration of the volume element to calculate the electromagnetic mass in the Feynman lecture and revisited further on in this paper.

If the electrostatic potential energy is proportional to half the electron mass and is changed by a factor of (4/3), then the full electron mass will be modified to ⅓ of its value.

Using the  $\beta^2$  velocity distribution, one can see this (4/3) factor in the electromagnetic mass calculation to be the average between the two A-values as  $\frac{1}{2}(\frac{1}{2}+1) = \frac{3}{4}$  for a corrected electron mass of  $\frac{2}{3}m_e$  and for a surface distribution for the electron.

The problem with the electromagnetic mass so becomes an apparent 'missing mass' in its distribution between the electric- and magnetic external fields and the magnetopolar self- interaction fields as indicated in this paper.

In the diagram above the mass of the electron is distributed as  $m_{ec}$  in the unitary interval applied to the Compton constant and where exactly half of it can be considered imaginary or complex from  $A=0$  to  $A=\frac{1}{2}$ .

The mass of the electron at  $A=0$  is however simply half of its effective mass  $m_e$ , which is realised at the half-way point at  $A=\frac{1}{2}$  as the new origin of the electron's electrostatic energy without velocity in the absence of an external magnetic field.

We have seen however, that the electrostatic electron carries a minimum eigen-velocity and so magnetopolar self-energy, calculated as

$$v_{ps} = 1.50506548 \times 10^{-18} \text{ c and manifesting not as a dynamic external motion, but as}$$

$$f_{\alpha\omega} = 2.84108945 \times 10^{-16} = \sum f_{ss} = \sum m_{ss}c^2/h = f_{\alpha\omega}/f_{ss} = 8.52326834 \times 10^{14} \text{ mass- or frequency self-states.}$$

### M-Sigma conformal mapping onto $\{m_{e0}/m_e\}^2$ in the $\beta^2$ distribution

As the  $\beta^2$  distribution is bounded in  $\{A_{ub} - A_{lb} = \frac{2}{3}\alpha^{2/3}\}$  as a sub-unitary interval in a smaller sub-interval of  $\frac{1}{2}\alpha_{var}$ ; the SI-CODATA value for the Restmass of the electron is derived from first inflaton-based principles in a conformal mapping of the M-Sigma relation applied to the Black Hole Mass to Galactic Bulge ratio for the alpha bound.

Minimum Planck Oscillator $\frac{1}{2} E_o  \Leftrightarrow  E_{ps} ^* = 1/ e^* $	$\frac{1}{2} E_{ps} $	$\frac{3}{4} E_{ps} $	$1 E_{ps} $	$5/4 E_{ps} $	$3/2 E_{ps} $
Value in energy (Joules; Joules*)	1/1000	1/666 $\frac{2}{3}$	1/500	1/400	1/333 $\frac{1}{3}$
Value as modulated to A-interval as M-Sigma	$1 \times 10^{-3}$	$1.5 \times 10^{-3}$	$2 \times 10^{-3}$	$2.5 \times 10^{-3}$	$3 \times 10^{-3}$
$ E_{ps} ^*/ e^* $ to reunite-renormalize $E^*e^*=1$	$2 \times 10^{-6}$	$3 \times 10^{-6}$	$4 \times 10^{-6}$	$5 \times 10^{-6}$	$6 \times 10^{-6}$
$\frac{2}{3}$ -value in partition interval $\frac{2}{3}m_e.(3/2)R_e$ for mean $A=\frac{3}{4}$	1/2	3/4	1	5/4	3/2
<b>Fraction of Renormalization effect</b>	<b>1/3</b>	<b>1/2</b>	<b>2/3</b>	<b>5/6</b>	<b>1</b>
Value of $\Delta(\frac{1}{2}\alpha_{var})$ in $A_{6lb} - A_{6ub}$ and in $A_{3ub} - A_{3lb}$	<b><math>2 \times 10^{-6}</math> complex minimum</b>	$3 \times 10^{-6}$	$4 \times 10^{-6}$	$5 \times 10^{-6}$	<b><math>6 \times 10^{-6}</math> real maximum</b>

The  $\frac{1}{2}\alpha_{var}$  sub-interval so is adjusted by  $6 \times 10^{-6}$  from  $A_{6ub} - \Delta(\frac{1}{2}\alpha_{var}) = A_{SI}$  for  $\beta_{SI}^2$  for  $m_{e0}SI$  for the real solution



## The Schwarzschild Classical Electron as a Planck function for a Quantum of Physicalized Consciousness

$$m_{ebh} = R_e c^2 / 2G_o = e^* / 4G_o |_{\text{mod-mass}} = V_{rmp} \cdot df/dt |_{\text{max}} / 4G_o = 2\pi^2 R_{rmp}^3 \cdot f_{ps}^2 / 4G_o = 1.125 \times 10^{12} \text{ kg}^*$$

is the Schwarzschild wave matter mass for a classical electron with curvature radius  $R_e$  and effective electron mass  $m_e$  in the electromagnetic interaction  $E^*$ -Gauge photon of the supermembrane displacement transformation between the monopolar and electropolar universal charge quanta  $e^*$  and  $e$ , respectively.

The energy density for this modular 'dark matter-consciousness' electron as function of the 'Planck Vacuum' becomes:

$$\begin{aligned} \rho_{\text{planck}} &= m_{\text{planck}} / V_{\text{planck}} = m_{\text{planck}} / L_{\text{planck}}^3 = 2\pi c^5 / h G_o^2 = \{8\pi c^3 \lambda_{ps}^2 / h G_o\} \cdot \{f_{ps}^2 / 4G_o\} = 1.855079 \times 10^{96} \text{ (kg/m}^3\text{)}^* \\ \rho_{\text{ebh-rmp}} &= m_{\text{ebh}} / V_{rmp} = df/dt |_{\text{max}} / 4G_o = f_{ps}^2 / 4G_o = 2.025 \times 10^{70} \text{ (kg/m}^3\text{)}^* = 1.0916 \times 10^{-26} \rho_{\text{planck}} \\ M_{rmp} &= m_{\text{fermi}} = h / 2\pi c R_{rmp} = 2.50500365 \times 10^{-23} \text{ kg}^* \text{ or } 14.034015 \text{ TeV}^* \end{aligned}$$

is the Compton-de Broglie wave-matter mass for the Restmass Photon  $rmp$  as the 'dark matter' agent in the UFOQR and here redefined as the 'Particle of Universal or Cosmic Physicalized Consciousness.'

$$R_{rmp} = \sqrt[3]{\{V_{rmp} / 2\pi^2\}} = \sqrt[3]{\{2R_e c^2 / (2\pi^2 \cdot df/dt |_{\text{max}})\}} = \sqrt[3]{\{e^* / 2\pi^2 f_{ps}^2\}} |_{\text{mod}} = \sqrt[3]{\{1 / 2\pi^2 h f_{ps}^3\}} |_{\text{mod}} = 1.411884763 \dots \times 10^{-20} \text{ m}^*$$

for a unitary calibration for the  $rmp$  in  $[m^3]^* = [s^3/h]^*$  and  $[m]^* = [s]^* / \sqrt[3]{h}$  for  $M_{rmp}$  in  $[kg]^*$   
 $= [Js^2/m]^* \times \sqrt[3]{h} / [s]^* = [Js/m]^* \times \sqrt[3]{h} = [kg]^*$

$M_{rmp} = m_{\text{fermi}} = h / 2\pi c R_{rmp} = \{h / 2\pi c\} \cdot \sqrt[3]{\{2\pi^2 h f_{ps}^3\}} |_{\text{mod}} = \{h f_{ps} / c\} \sqrt[3]{\{2\pi^2 h / 8\pi^3\}} |_{\text{mod}} = \{E_{ps} / c\} \sqrt[3]{\{h / 4\pi\}} |_{\text{mod}}$   
 $M_{rmp} = h / 2\pi c R_{rmp} = \{E_{ps} / c\} \sqrt[3]{\{h / 4\pi\}} |_{\text{mod}} = 2L_{\text{planck}}^2 c^2 / R_{rmp} R_e = L_{\text{planck}}^2 c^2 / G_o R_{rmp}$  in the equivalence of the Gravitational parameter applied to de Broglie wave matter  $M_{dB}$  in  $4G_o M_{dB} = 2R_e c^2 = e^*$  with the Star Coulomb  $[C^*]^*$  as the unit for physicalized consciousness.

Closed Planck-String class I Finestructure Constant for monopolar mass displacement current

$$[M] = [ec] |_{\text{mod}} = [2\pi R_e] |_{\text{mod}}:$$

$$M_{rmp} / m_{\text{ebh}} = 2h G_o / 2\pi c^3 R_{rmp} R_e = 2L_{\text{planck}}^2 / R_{rmp} R_e = 2.226669925 \times 10^{-35} = 1 / 4.491011392 \times 10^{34} = \text{Order}\{\text{Planck-Length}\}$$

Dark Matter-Physicalized Consciousness Finestructure Constant:

$$R_e / R_{rmp} = 4\pi G_o M_{rmp} m_{\text{ebh}} / hc = 62,625.09124 = 1 / 1.596804061 \times 10^{-5}$$

The nature of the universal Schwarzschild classical electron as a high-density form of de Broglie wave matter so becomes an elementary agency for quantum gravity manifesting from the hyperspace of the multi-dimensional cosmology as non-Baryonic form of matter energy and is related to the definition of physicalized consciousness in the Unified Field of Quantum Relativity (UFOQR).

The UFOQR is based on Vortex-Potential-Energy or VPE as the non-virtual, but Goldstone Boson gauged Zero-Point-Energy Heisenberg matrix of spacetimes.

Möbius had broken into two and had transferred his one-sidedness to the Klein mirror and in a dimensional twinship between Klein's heness in the 12th dimension at the Instanton of Khaibit and Klein's sheness at the Instanton in Universe in the 10th dimension of the 11-dimensional two-sided manifold, Logos called the M-spacetime of the Mother as a Magic Mirror of the Mystery of Witten.

Klein's sheness so brought the UFOQR with its matter-antimatter definitions and acting under the auspices of the gauge ambassadors into the 10th dimension of the superstrings of Universe of the Mother as the Queendom of Baab from the 12th dimension of the Kingdom of the Father.

The matter templates YCM so could interact with their antimatter counterparts MCY in a new way, as the quantum relativity between them had changed from its 2-dimensional origin with no thickness to a 3-dimensional evolvment , due to the thickness of the Inflaton-Instanton interval in the birthing of space-time.

In particular  $YCM(1)+MCY(-1) = (Y+M)C^2(M+Y)(0) = RCCR(0) = GMMG(0) = BYYB(0)$  in the mixing of the colour charges.

This created a new template, the Universal Intelligence called the Vortex-Potential-Energy or VPE as a Vacuum-Potential-Energy or a Zero-Point-Energy in the UFOQR.

This zero-spin or scalar VPE so had been defined as the Dark Energy or DE from Khaibit to continue the Inflaton of the hyper acceleration of the de Broglie wave-matter of the mass seed  $M_o$ .

Because the Inflaton had defined the Hubble event horizon as a Black Hole  $M_H = R_H c^2 / 2G_o$  , this gradient of Black Hole masses  $M_o/M_H = \Omega_o$  defined a parameter  $\Omega_o = 0.028$  as the difference between the Hubble Mother Black Hole and the mass seed  $M_o$  from the creation algorithm of the Mathimatia.

This Black Hole Mass parameter  $\Omega_o$  so would specify  $M_o$  as the mass seed and as a form of mass energy Abba named as the 'Baryonic Matter Seed' and it was the baryonic matter that would interact with the EMR as photons without colour charge as a luminous form of matter.

The Inflaton parameters of the de Broglie wave matter had been the hyper-acceleration  $A_{dB} = R_H \cdot f_{ps}^2$  and the superluminal hyper-speed  $V_{dB} = R_H \cdot f_{ps} = R_{HC} / \lambda_{ps}$ , incorporating Abba's resonance self-state or eigen frequency  $f_{ps}$  into the birth of the cosmos.

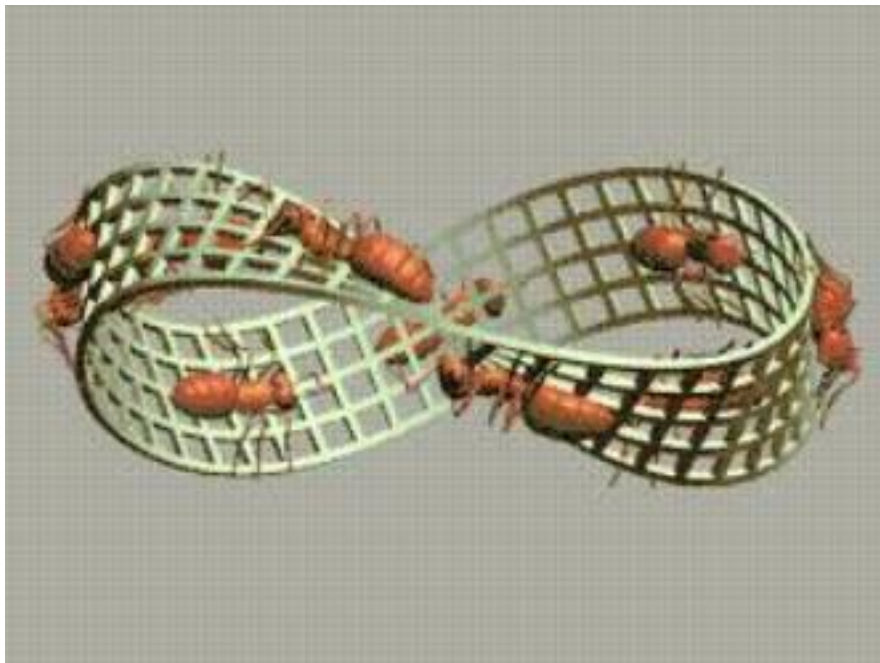

## **XV: The birth of the universe in space and time from physicalized universal consciousness**

Time began, when the nonexistent and the uncreated became conscious of itself and what 'It' was, as also being 'It' as the existent and as the created. The difference between the uncreated and the created then describes the concept of time as a process for 'It' of becoming conscious of itself in the form of a universal self, using time potentials to experience itself as a form of energy. 'It' created itself as a universal self in realizing its own potential from the uncreated state of 'It' in no time to create itself in 'Now time,' and therefore giving birth to time.

Consciousness so is a form of source energy, which forms a relationship between the nonexistent and uncreated and the existent and created. This original consciousness also forms a partnership between the energy forms in existence and the energy forms not in existence in the form of the consciousness energy as imagination.

The not existing or 'Nothingness' of a potential and eternal void was as 'One' with the 'Every thingness' of 'All that It could have been' and was as 'All That Is' and could be in a realization of the energy potentials contained in the eternity of the void.

And the movement and dynamic of differentiating the potentials of the 'could have been' from the potentials of the 'could be' became the definition of differentiating the order of before and after as a flow of time from the relative past to the relative present to the relative future.

The imagination in self-consciousness so exists to realize the potentials of the source energy in a form of the forethought realizing itself as the afterthought. This process connects the time relative past with experienced realized energy potentials through the time relative present moment or now time to the time relative future with not experienced and unrealized energy potentials of the source energy, albeit distributed in the parts of the source energy.

The source energy so experiences the 'flow of time' as a principle of order where event B cannot occur before event A has become happenstance in the realization of a relative time potential.

The relativity of time potentials then becomes self-relative in the form of the source energy and its partition into sub structures of the precursor or parent source energy. The duration between events A and B so becomes a function of the relativity of time as experienced or measured or counted in the distributed forms of the source energy and as a self-relativity of the worlds within worlds of an encompassing overworld or super realm of the source energy.

This super world is known as universe emerging from a protoverse to evolve into a multiverse and being encompassed as an omniverse as a necessary boundary- and initial condition to enable the source energy experience itself through the time potentials in a spacetime interwoven with the time potentials.

The birth of the universe is known as the separation of a world above called 'Heaven Above' from a world below called 'Earth Below' in the creation of a spacetime mirror called the 'Firmament.'

This process was the separation of the 'Notime' from the 'Now time' and defines the original realization of the original time potential by the source energy. This process is also known as a quantum fluctuation of a mathematical singularity, physicalizing the metaphysical or 'spiritual' universe without the parameter of spacetime within a spacetime defined in the mathematical singularity.

The creation and birth of time so also gave birth to spacetime in the form of the mathematical singularity defining both a space parameter and a time parameter to become interwoven or 'quantum entangled' with each other in a spacetime parameter, known as the wormhole parameter of a quantum tunnel connecting the two worlds separated by the firmament of the spacetime mirror.

The quantum tunnel, connecting heaven to earth, so is also known as an Einstein-Rosen bridge connecting a Planck-Stoney cosmology to a Weyl-Hawking cosmology in the utility of a 12-dimensional Vafa-Witten spacetime mirror.

The Planck-Stoney cosmology then forms the higher dimensional universe known as the membrane-superstring physics using the 11<sup>th</sup> dimension in a mirror symmetry to connect the 12<sup>th</sup> dimension of an 'old heaven' to the 10<sup>th</sup> dimension of an 'old earth', emerging or evolving from the 1<sup>st</sup> dimension and mirroring a 0<sup>th</sup> or Null dimension in the 13<sup>th</sup> dimension as a boundary for the 'old heaven'.

The lower dimensional universe is bounded in the 1<sup>st</sup> dimension and so is the mirror image of the 12<sup>th</sup> dimension across the mirror of the 11<sup>th</sup> dimension, which so is also the 2<sup>nd</sup> dimension in the root reduction of the numbers  $12=1+2=3$  with  $11=1+1=2$  and  $10=1+0=1$ .

The lower dimensional universe so occupies the spacetime of 3 space dimensions and connects to the higher dimensional universe in a 4<sup>th</sup> spacetime dimension.

The 4<sup>th</sup> dimension so is a time dimension, which can also be a space dimension, should the higher dimensional universe reconfigure itself by using the spacetime mirrors of the 2<sup>nd</sup> and 11<sup>th</sup> dimensions in a transformation of the 8 dimensions between dimensions 2 and 11 and in using the quantum tunnel as the thickness of the universal mirror of universal time.

The 3<sup>rd</sup> space dimension so is born and created in transforming the 8 dimensions in the quantum tunnel as a new mirror of time as the 7<sup>th</sup> dimension separating dimensions 8, 9 and 10 from dimensions 4, 5 and 6 in a trio of time dimensions 4, 7 and 10.

The mathematical singularity or quantum fluctuation creating the universe in spacetime from the consciousness of the nowhere in notime, so partitioned a 12-dimensional universe into 4 worlds in spacetime and 3 worlds of 4-dimensional space in notime.

The first world of 4-dimensional line-space of dimensions 1, 2, 3 and 4 is connected to the second world of 4-dimensional space of dimensions 5, 6, 7 and 8 as a 7-dimensional rotation-space by the 4<sup>th</sup> spacetime dimension known as Minkowski time-space and the second 7-dimensional world is connected to the third world of 4-dimensional space as a 10-dimensional vibration-space by the 7<sup>th</sup> spacetime dimension, known as Penrose time-space.

As the third world of four space dimensions without time manifests dimensions 9, 10, 11 and 12; a third time-space is created in the 10<sup>th</sup> space dimension, known as String time-space.

The three worlds of 4-dimensional spacetimes so are described as occupying line-space, twistor-space, frequency-space and quantum-space in 1-3 and 4-6 and 7-9 and 10-12 dimensions as four worlds of spacetimes connected to each other in a shared time-space dimension closing the 3 dimensional continuum or circle from the 1<sup>st</sup> dimension to the 12<sup>th</sup> dimension in time connector dimensions 4, 7 and 10 or the algorithmic sequence:

Begin(1|0)-2-3-(4|1)-5-6-(7|2)-8-9-(10|3=1\*)-(11|2=2\*)-(12|1=3\*)-(13|0=4\*)End.

This process forms the boundary-initial condition of mirroring heaven in earth in the dimensional root reductions of  $10=1+0=1$  and  $11=1+1=2$  and  $12=1+2=3$  defining the line-space, the area-membrane-space, and the volumar-space in 3 dimensions in the lower dimensional universe but mirrored in the higher dimensional universe in dimensions 10, 11 and 12.

The 8 dimensions describing the 'thicknesses of the spacetime mirror connecting heaven to earth, so originally manifest the physical universe in the birth of spacetime in the wormhole parameters of the Weyl-Hawking cosmology. It does this in transforming a one-sided mirror, known as the dragon Möbius, defined in 2 dimensions of a 3-dimensional space into a two-sided mirror, known as the dragon Klein.

The dragon Möbius resides in the area- or membrane space of the Mathimatia, which is a label describing the consciousness realm of 'Universal Intelligence' also known as the Universal Word or Logos-Sophia.

Möbius so is both a 2-dimensional mathematical dragon and a 11-dimensional mathematical dragon connecting its membrane space of geometric occupancy to its environmental space as its cave of residence or embedment of 3-dimensional geometry in the lower dimensional universe of the old earth and the 12-dimensional geometry in the higher dimensional universe of the old heaven.

The transformation of the old heaven with the old earth into a new heaven with a new earth then is defined in the dragon Möbius in mathematical 2-dimensional membrane space and residing in mathematical 3-dimensional volumar space changing into the dragon Klein defined in 3-dimensional volumar space and residing in 4-dimensional volumar space, also known as hyper-space within a 5-dimensional spacetime with the 7<sup>th</sup> dimension of Penrose time-space.

The Möbius-Klein dragon metamorphosis of Minkowski time-space into Penrose time-space with the transformation of 3-dimensional line-space within 4-dimensional spacetime into 4-dimensional hyper-space within 5-dimensional spacetime so changes the one-sidedness of the Möbius dragon mirror into a two-sidedness of the Klein dragon mirror.

Before the transformation, the old heaven in the 12<sup>th</sup> dimension is trapped and restricted in the so is one-sidedness of the self-reflection of the consciousness of the source energy.

The creation of the universe and the quantum tunnel required the thickness of the 11-dimensional quantum mirror to transform this thickness into its lower 10-dimensional equivalence as a medium of self-reflection for the source energy.

The 10-dimensional String time-space so expanded itself through the wormhole parameters of the Planck-Stoney and the Witten-Hawking cosmologies from the 11<sup>th</sup> dimension as a root reduced 2<sup>nd</sup> dimension and so creating the 3<sup>rd</sup> dimension of the line-space in the quantum tunneling of the 12<sup>th</sup> dimension through the thickness of the quantum tunnel as a 'timing machine'.

As this manifested the birth of space and time in a one-sidedness of direction from the 12<sup>th</sup> dimension to the 3<sup>rd</sup> and as the 3 worlds of volumars in the 4-space worlds of 1-4 and 5-8 and 9-12 dimensions, the old heaven became subject to the one-sidedness of the creation event of the quantum universe coming into existence from the consciousness or source energy of the creation-creation duality.

The old heaven so formed a creator-creation duality with the old earth and in which the creator part is defined in the darkness on the non-reflecting surface of the one-sided Möbius mirror as the left side above the firmament and the reflecting surface of the dragon Möbius, also known as the mirror of the Sabbath rest defining the light of the creation being emitted into the creation as the right side of the firmament below.

The existence of the universe in spacetime, then enabled cycles of light and darkness to prepare the time potentials to evolve into a process by which the old earth could become a new earth in using the dragon Klein as a two-sided spacetime mirror embedded in a 4-dimensional space as a 5-dimensional hyper-spacetime.

The two-sidedness of Klein would then be able to reflect a processed monopolar electromagnetic source light to back towards the 11-dimensional Witten mirror as a consequence of the breaking of the Möbius mirror destroying the one-sidedness and replacing it with the two-sidedness of Klein. The replacing of the archetypical low vibration red dragon Möbius with the archetypical high vibration blue dragon Klein would so create a new heaven as the image of the new earth.

The creator-creation duality so describes the original existence-nonexistence dichotomy as a dyadic monad of being two things within one thing, but unable to experience the two things as one unity, due to the in separateness of the two things in the absence of the existence of space to separate in.

A monadic dyad as two things unified as one thing would however allow a separating in space between the two things, if the two things could become irrevocably connected with each other. The time potentials of the source energy so define the quantum entanglement as a space independent parameter of spacetime as a primary foundation for the cosmology of the source energy as universal consciousness.

The old heaven so released its consciousness energy as electromagnetic-monopolar light to enable the transformation of consciousness into energy forms subject to spacetime parameters derived from the wormhole cosmology of the mathematical singularity geometrically defined in the dragon Möbius, transforming into the dragon Klein using the time potentials of the source energy as universal consciousness.

This transformation of source energy was initiated in the Planck-Stoney cosmology, which defined interdependent units for measurement and experience under the guidance of universal principles, also known as the laws of nature.

The time potential for the transformation of the Planck-Stoney cosmology into the Witten-Hawking cosmology became realized in the quantum tunneling creating the 3<sup>rd</sup> dimension from the thickness of the 11-dimensional Witten membrane mirror and allowed the transmutation of five superstring classes of the 10-dimensional String time-space into each other in a gradient of energy between the five classes.

The first class so is known as the Planck string, the second class as a Monopole string, the third class as a XL-boson class, the fourth class as a Cosmic Ray string and the fifth class as a Weyl string, the last enabling the 4-dimensional Minkowski spacetime to emerge as a Einstein-Maxwell-Planck cosmology, descriptive of a thermodynamic expansion of the universe as a Black Body Planck Radiator emitting electromagnetic radiation in frames of references relating inertial mass parameters with non-inertial parameters.

## **The definition of physicalized consciousness in the reference frame of the source energy of universal intelligence**

As a noninertial frame of reference experiences a form of acceleration relative to an inertial frame of reference; the form of acceleration becomes the mode of operation for measurements using the laws of nature.

When measuring the weight of something on the earth's poles, this weight will be greater than if measured on the equator by about 0.53 %, because there is no horizontal force on the weight as the earth spins around its axis; but there is a 'fictitious horizontal force' on the equator, where the weight moves in a circle about the axis of the earth in a period of rotation of about 24 hours.

The vertical reaction force on the weight on the poles exactly balances the action force of gravity without any horizontal force component; but on the equator the vertical action force of gravity is balanced by both, the vertical reaction force of the weight and a vertical component, horizontal relative to the poles, as the fictitious centrifugal force.

The gravitational action so is measured as a reduction in weight and in the absence of the centrifugal force component. This example supposes a perfect spherical symmetry for the earth. As the earth is flattened on the poles as an oblate spheroid, gravity on the poles is greater than at the equator as the poles are closer to the center of the earth, than is the equator.

It is so the inertia, which causes fictitious forces as non-accelerated frames of reference for measurement and observation in a classical physics of Newton's laws and Einstein's extension of the laws of mechanics in the curvature of spacetime incorporating the inertial frames of reference of Special Relativity within the non-inertial accelerated frames of reference of General Relativity.

The classical physics of Newton, Maxwell and Einstein is based on the geometry of spacetime and is applied to describe the geometry of the universe as an interaction of physical entities within a spacetime of both inertial and non-inertial reference frames. Minkowski spacetime is considered flat without curvature and Penrose spacetime is considered curved or twisted in a geometry of positive ellipsoidal or negative hyperbolic curvatures underpinning the force of gravity as a curvature of spacetime interacting with mass as the basis of inertia.

The physical basis for consciousness as the source energy so becomes the precursor of inertia and so mass in the original nature of a non-inertial reference frame. The mass content of the universe at the creation event of the quantum tunneling of the 12<sup>th</sup> dimension transforming into the 3<sup>rd</sup> dimension of the parameters of the Weyl string and as the total inertia of the universe was caused by the non-inertial and so accelerated frame of reference of the source energy in form of universal spacetime consciousness quantum tunneling as a function and derivative of the Planck string transforming into the Weyl string.

The non-inertial reference frame of the source energy so defined the original spacetime unit as a source energy quantum of physicalized consciousness in the Weyl wormhole parameters of creation, also known as a Quantum Big Bang.

The connection and unification between all forms of energy as derivatives of the source energy of universal consciousness so is found in the Mathimatia of the Universal Logos-Sophia, which utilizes the Euclidean classical geometry of Newton, Maxwell, and Einstein therefore from a quantum geometry of Planck, Stoney, and Witten.

## The Core-Awareness of the Earth, the Moon, and the Sun

The model of physical consciousness as a form of energy encompasses all ideas of 'spirituality' and labels of immaterial existence; if one can qualify and quantify this energy as something capable of existing independent from material parameters.

But as spacetime-matter exists in say a commonly shared earthly 3D-space 1D-time experience; this self-same consciousness-energy is certainly required to influence and to interact with the material realms of the spacetime matter.

So, this little excursion will attempt to elucidate the nature of awareness as a component for this consciousness of being within say a volume of space and illustrate how this spacial awareness relates to the most fundamental concepts of gravitation.

What is the consciousness of this planet earth or what is the source energy 'coupled' to the earth's satellite - the moon? The sun, a yellow typical star of class G2V on the main sequence of the Hertzsprung-Russell chart of spectral classifications encompasses the planet as the gravitational center of the so defined solar system. The sun provides energy for this solar system like a benevolent parent; what is its core consciousness?

A basic definition for the Source-Consciousness as the magneto charge quantum  $e^*$  (in uncommon units of the Star Coulombs) being the inverse source energy quantum (in common energy units say Joules or Electronvolt).

$e^* = \text{Volume} \times \text{Awareness} = \text{Electron-Field Diameter} \times \frac{df}{dt} = 500 \text{ C}^*$  as the boundary condition for  $\frac{df}{dt} = f^{*2}$  for a Volume  $2R_e \cdot L_{\min}^2$ .

[\(PDF\) Physical Consciousness in a Self-conscious Quantum Universe | Anthony P Bermanseder - Academia.edu](#)

Now consider the manner the Mass of the Earth was calculated by Henry Cavendish in 1798. Newton's Law for Gravitation applied to a 'point-mass,' or 'test-mass'  $m$  gives the Gravitational Acceleration  $g_{\text{Earth}} = 9.8 \text{ m/s}^2$ .

$F_{\text{grav}} = GmM_{\text{Earth}}/R_{\text{Earth}}^2 = mg_{\text{Earth}}$  and this can be solved for the Mass of the earth as about  $6 \times 10^{24} \text{ kg}$ .

It is well known that the mass of the earth can be considered to be concentrated at the 'center of gravity', say coinciding with a spherical mass- or density distribution and which would be the geometric center of a sphere for perfect spherical symmetry.

The 3D-physics then is rendered 4-dimensional in doing just such a 'center of mass' and in Einstein's theory of General Relativity.

Here then the gravitational acceleration is described as a curvature of spacetime around this mass distribution and in an extreme case this curvature leads to a 'total collapse' for this mass concentration into the mSchwarzschild metric termed a Black Hole.

So, replacing the radius of the earth by the Lightpath  $x=ct$  will of course define the amount of time for light to travel from the surface to the center of the earth.

As the earth is on average so  $2R_{\text{Earth}} = 12,735,000$  meters across as the light path, the time taken is about  $t = R_{\text{Earth}}/c = 0.0212$  seconds or it would allow light to oscillate almost 24 times in between the poles in one second say.



$F_{grav} = GmM_{Earth}/R_{Earth}^2 = mg_{Earth}$  becomes

$GM_{Earth}/x^2 = g_{Earth} = GM_{Earth}/(ct)^2 = \frac{1}{2}(2GM_{Earth}/c^2) \cdot (df/dt) = \frac{1}{2}R_{SEarth} \times \text{Awareness}$  and as  $t^2 = df/dt$  as a so defined awareness differential and defining a Core-Awareness in a  $t^2$  primary term.

So, the mass of the earth becomes 'Black Holed' in the curvature radius  $R_s = 2GM/c^2$  and the deciding factor becomes the gravitational acceleration Awareness =  $2g_{Earth}/R_{SEarth}$ .

Then, using the known mass of the earth and its 'BH-Radius'  $\sim 9$  mm (all calculations use the 'constant'  $G = G_0 = 1.11 \times 10^{-10} \text{ Nkg}^2/\text{m}^2$  value as  $G_0 k_e = 1$  as string parameter in BH-physics and  $G = 6.674 \times 10^{-11}$  'G-units' for the orbs); Awareness<sub>Earth</sub> = 2202  $1/s^2$  units and with a Base-Frequency  $F_{base}$  of about 47 Hz.

This is the 7th Schumann Harmonic or Resonance for planet earth in the harmonic series: 7.8; 14.3; 20.8; 27.3; 33.8; 40.3; 46.8 in a delta function of 6.5 Hz.

The basic Schumann harmonic is simply the circumference of the earth travelled as the light path and so is 40,000,000 meters/c  $\sim 0.133$  seconds for a Base-Frequency of  $1/0.133 \sim 7.5$  Hz.

{This is esoterically encoded in the Book of Revelation as the 'outside' of the holy city in proportion to its 'inside' and as 1,600 furlongs and 12,000 furlongs: Rev.14.20 & Rev.21.16}.

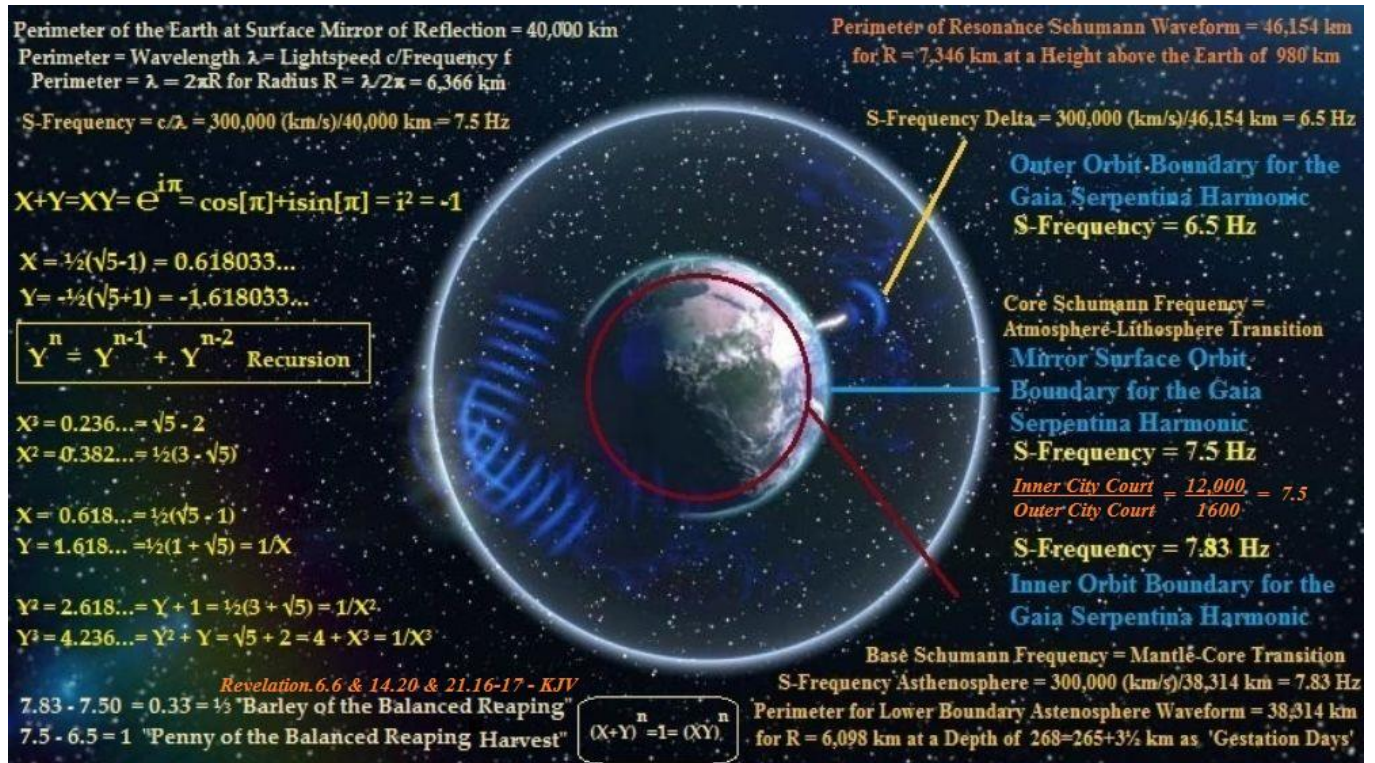

More generally, the Awareness as hereby described is known as Alpha Omega with Greek Symbols  $\alpha\omega = a\omega$  as a convenient abbreviation. Those awareness units then inversed and square-rooted will of course become the time taken for the light path to the center of the earth as 0.021 seconds.

But this time measurement is also an awareness measurement which so gives a Core-Awareness for the planet earth independent of any frequency modulations  $df/dt$ .

In modern terminology then, the Awareness is an infinite series of factors each giving a contributing awareness differential as a frequency modulation: Awareness/Earth = 2202 + ... + ... = Core-Awareness + Summation of frequency differential contributions of earth constituent systems.

In a similar derivation then: Awareness/Sun = 0.18 + Integration... and for  $F_{\text{base}} \sim 0.43$  Hz with light path  $6.96 \times 10^8$  meters and  $g_{\text{Sun}} = 275 \text{ m/s}^2$  and  $R_{\text{SSun}} = 3$  km.

Awareness/Moon = 29,640+ Integration... and for  $F_{\text{base}} \sim 172$  Hz with light path  $1.738 \times 10^6$  meters and  $g_{\text{Moon}} = 1.63 \text{ m/s}^2$  and  $R_{\text{SMoon}} = 0.11$  mm.

The greater the light-path, the smaller the Core-Awareness and so the separation between the say Emitter and the Receiver of the Information 'sent' by the light path defines this inverse proportionality. The 3D-physics of the c-invariance so assumes a deeper significance as it indicates the importance of the environment for the Integration of the individuated Awareness Carriers.

The Core-Awareness as defined so does not vary in the differential and becomes a direct consequence of the constancy of the speed of light.

But any constituent consciousness carriers will be able to interact environmentally with each other in a collective sense and so change the awareness of the self as the Source-Consciousness.

So, for example the information exchange between a tree and a hill can be approximated in their 'Black Holed' Inertia, but only as a Core-Awareness and not considering the kaleidoscope of interactions in all of the kingdom of crystal, mineral, animalia, archaea, bacteria, and fungi and so on.

So, taking the tree and the hill in isolation without the possibility of interaction, their awareness content would become like a constant as described.

But any interacting environment engages in multiple feedback cycles which change the awareness of that environment. A little ant in isolation and about 2 mm in length as the light path would require a frequency  $c/2 \text{ mm} = 1/t^2 = 1.5 \times 10^{11}$  Hz and so electromagnetic radiation in the infrared part of the spectrum to 'share' its core-awareness of  $2.25 \times 10^{22}$  awareness units.

Generally, then, the concept of Self Awareness as here modelled engages a Core-Awareness to which is added or subtracted the environmental interactions.

The kingdoms of fauna and flora and the archaeon, the prokaryotes and the eukaryotes will interact in systems and subsystems of multitudinous diversity. The Awareness of individuated and/or collective constituents will vary in this interaction and is described in the differential equations, which employ the time derivatives for frequency in an appropriate manner.

As the inertial mass can be shown to be a derivative of its precursor gravitational mass and this gravitational mass as Gravita can be described as superconductive 'natural current' of magneto-monopolar origin and so linking to the magneto charge as a model for the Inverse Source Energy as physical consciousness; the differential equations used to describe 'normal' electricity in 3D can be reformulated to describe the 'Life-Force' as such a 'natural electricity' requiring not any medium such as a copper wire, but only spacetime quantization itself.

The second order of say Voltage  $V = L \cdot d^2 q / dt^2 + R \cdot dq / dt + q / C$  reduces to first order in the awareness differential and where the quantized charge counter 'Ne' becomes a constant coefficient in the mathematical expressions.

Then an RCL-'life-circuit' will differ from a 'RC'- or an 'LC' circuitry and allow self-and mutual frequency inductions to modify the overall 'life-circuits'.

The environmental interactions between 'RC'-current elements can be modelled on a 'Capacitive Awareness', which one can label as instinctual or as nonanalytical. 'LR'-current elements can describe an 'Inductive Awareness' which is analytical with suppression of the instinctual (or emotional) component.

And any organism and awareness carrier, which harbours the full 'RCL'-circuitry will have both instinctive and analytical properties in its evolutionary potential and the search to obtain Source-Resonance.

Because the L-factor (as Y-chromosome) can be associated with a sex-chromosomic bifurcation of the DNA/RNA Codex of 64 permutations (and 20 Amino Acids), as well as the C-factor (as X-chromosome say with a unity  $X_0Y_0X_1X_2$  and where say  $X_2$  is a disguised  $Y_1$ ) a sexual differentiation embodied in the natural current equations can also be made.

Additionally, the C-Awareness cross induces the L-Awareness both mutually and self inductively and this can be modelled on say circuit diagrams, which also show that the separation from the Source-Energies (as minmax Potential Differences say) becomes a function of evolution in linear time and in which a completion for this evolution must be defined before its beginning and as a consequence for the initial parametrizations of the circuit components C, R and L.

In 4D/10D dS spacetime, the spacetime matter matrix of 4D is a lower bound for the c-invariance and the entire universe can be 'travelled' like a 'superposed' inflationary scenario.

Here, the awareness is of course upper bounded by the square of the source frequency in  $9 \times 10^{60}$  awareness units and as examined in the QBBS instanton-inflaton cosmology. The metric limit in 3D is the wormhole radius ( $R_{\min} = L_{\min}/2\pi$ ) for a source frequency of  $f^* = 3 \times 10^{30}$  Hz and of course nothing in 3D can be smaller than this.

But the Inflaton of the Instanton 'expanded' the 4D envelope for the 3D universe in a de Broglie Matter Wave Velocity  $V_{dB} = R_{\text{Hubble}} \cdot f^* \sim 10^{48}c$  and in an accompanying phase acceleration  $A_{dB} = R_{\text{Hubble}} \cdot f^{*2} \sim 10^{87} \text{ m/s}^2$  and in a manifestation of the cosmological initiatory and boundary conditions.

So, taking  $R_{\text{Hubble}} = ct^*$  for the source frequency  $f^*$  gives the Core-Awareness parameter for the Big Banged Universe as  $c/R_{\text{Hubble}} = 1/t^* = L_{\min} \cdot f^*/R_{\text{Hubble}} = H_0 = 1.88 \times 10^{-18}$  Hz and as a nodal Hubble-Constant.

This gives the ratio  $H_0/f^* = L_{\min}/R_{\text{Hubble}}$  and as the minimum/maximum condition in betwixt the cosmic evolution will define itself.

The minimum time is the time instanton defining a Now-Moment and this is  $1/f^* = 3.33 \times 10^{-31}$  seconds and so defines the maximum Awareness as  $(df/dt)_{\max} = f^{*2}$ .

Corollarily then, the entire universe of mass-seedling content  $M_0$  as a Black Hole at the critical mass  $M_{\text{critical}}$  can be described by  $R_{\text{Hubble}} = 2G_0 M_{\text{critical}}/c^2$  or  $M_{\text{critical}} = c^3/2G_0 H_0$  and as the critical energy content of the universe as the Sum of the Mass-Seedling  $M_0$  and the Consciousness manifested through and by the evolution of this (baryonic) inertia seedling under the auspices of the Awareness-Force  $F_{\alpha} = F_{\alpha} = \{\gamma h\nu/c^2\} df/dt$  supplementary to Newton's  $F_a = ma$  by [Eq.XII-4]

$$\begin{aligned} dp_{\text{rel}}/dt &= d(m_0 \gamma v)/dt = m_0 d(\gamma v)/dt + \gamma v d(m_0)/dt = \\ m_0 d(\gamma v)/dt + \{\gamma v h/c^2\} df/dt &= m_0 \gamma^3 \cdot dv/dt + \{\gamma v h/c^2\} df/dt = F_a + F_{\alpha} \text{ for } \gamma = 1/\sqrt{1 - [v/c]^2} \end{aligned}$$

Then for the entire universe, the 'time taken' to complete the light path  $R_{\text{Hubble}} = ct$  will differ in 3D without the de Broglie phase inflation and the 4D which contains the latter.

It will take 234.47 cycles of 16.9 billion years for the c-invariance as a lower bound in 4D/10D dS spacetime to quantum tunnel the protoverse into its first multiverse descendant initiated after the first semi-cycle completion for cycle time coordinate  $n=1$ .

This universal quantum tunnelling so negates an 'asymptotic eternity' gravitationally retarded expansion of the protoversal seedling for the multiverse within the omniverse. The c-invariance as an upper bound in 5D/11D AdS spacetime is continuous without gravitational and thermodynamic interaction for the protoverse and establishes the 'infinite evolution' of the Source-Consciousness and the Source-Energy to reattain the 0-entropy state of a spacetime matter less realm of consciousness existence.

Radius of Curvature  $r(n)$  with Salefactor  $1/a=1+1/n$  in dS as a function of cycletime coordinate  $n$

$$r(n) = r_{\text{max}} \left( \frac{n}{n+1} \right) m^* \quad \text{and} \quad n = H_0 t$$

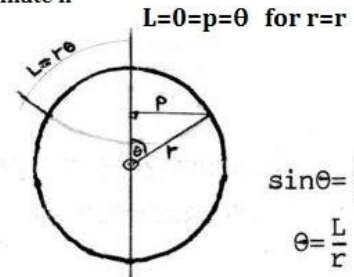

The volume of the 4-D spacetime can however be found by integrating the surface area S.A. via arclength  $L$ , with  $L$  being an intrinsic parameter of the 3-D surface.  $dL=r.d\theta$

$$V_{\text{Universe}} = \int_0^{r\pi} 4\pi p^2 dL = 2\pi^2 r(n)^3 \quad \text{for a local spheroidicity}$$

$$4\pi \int_0^\pi r^3 \sin^2 \theta d\theta = 4\pi r^3 \int_0^\pi \frac{1}{2} \{1 - \cos 2\theta\} d\theta = 2\pi^2 r(n)^3 \quad \text{for the asymptotic 4/10D dS 'flatness' cosmology within the nodal Hubble 5/11D AdS Universe}$$

This classical macrovolumar is quantized in the microvolumar quantum of the Unified Field in  $8\pi$  radians or  $840^\circ - (-600^\circ) = 1440^\circ$

$$\begin{aligned} & \frac{1}{4}\pi \int_{-600^\circ}^{840^\circ} \{ \sin(\frac{1}{2}[3x]) - \cos(\frac{1}{4}[3x]) \}^2 dx = \frac{1}{4}\pi \int_{-10\pi/3}^{14\pi/3} \{ \sin^2(3x/2) + \cos^2(3x/4) - 2\sin(3x/2)\cos(3x/4) \} dx \\ & = \frac{1}{4}\pi \int_{-600^\circ}^{840^\circ} \{ \frac{1}{2}(1 - \cos[3x]) + \frac{1}{2}(1 + \cos\frac{1}{2}[3x]) - \sin\frac{1}{2}[9x] - \sin\frac{1}{4}[3x] \} dx \\ & = \frac{1}{4}\pi \left[ \theta - \sin[3x]/6 + \sin\frac{1}{2}[3x]/3 - 2\cos\frac{1}{2}[9x]/9 - 2\cos\frac{1}{2}[3x]/3 \right]_{-10\pi/3}^{14\pi/3} = \frac{1}{4}\pi(8\pi) = 2\pi^2 \end{aligned}$$

{ by classical volumar of revolution (vor) }  
 $V_{\text{vor}} = \int \pi y^2 dx \quad \text{for } y=r$

The amplitude for the universal wavefunction becomes proportional to the quantum count of the space occupancy of a single spacetime quantum and as source energy (VPE or Vortex Potential Energy) quantum and as a consequence of the preinflationary supersymmetry of the  $F(x) = \sin x + \sin(-x) = 0$  wavefunction defining this singularity (symbolised as the symbol for infinity).

A higher dimensional surface is Moebian connected to differentiate the quantum mechanical 'boundary' for the quantum tunneling of the macrocosmos as a magnified holofractal of the well understood microquantumization.

It then is the experienced and measured relativity of time itself, which becomes the quantum wall, with the 'reducing thickness' of the quantum boundary correlating with the evolution of the multiversal structure in the phase shifted time intervals defining the individual universes.

## The Origin of energy in the Universe as a transformation of the mathematical-metaphysical singularity as a Planck-Stoney Quantum fluctuation of Dirac's magnetic monopole

It then becomes a quantum acceleration, which forms the basis for a physical definition of the source energy and physicalized consciousness. Angular acceleration of an elementary particle, such as a proton, a neutron, an electron, or a neutrino is known as quantum spin defined as a half-integer fermionic quantum rotation or as an integer bosonic quantum rotation multiplied by a constant spacetime parameter called Planck's constant  $h$  divided by  $2\pi$ .

Angular acceleration is independent from linear displacement, the parameter of linear extent being replaced by angular extent. In the quantum geometry of the source energy, the units of measurement or mensuration for the quantum acceleration so assume the form of frequency divided by time or the inverse of the square of time, generalised as the time differential of frequency or  $df/dt$ .

Logos Mathimatia or the universal intelligence then defines the parameter  $df/dt$  as the unit of spacetime awareness, which if multiplied by the wormhole volume of the Weyl string  $V_{\text{weyl}}$  of the Quantum Big Bang will define the source energy quantum from first principles as {proportionality constant}  $V_{\text{weyl}} \cdot \{df/dt\}_{\text{weyl}} = E_{\text{weyl}} = hf_{\text{weyl}} = m_{\text{weyl}} c^2 = k_B T_{\text{weyl}}$ , in the mathematical formulations for the energy transformations in electromagnetic radiation (Planck) and mass (Einstein) and temperature as kinetic energy (Stefan-Boltzmann) respectively.

A supersymmetry between the electric- and magnetic field vectors in Maxwell's equations for electro-dynamical energy systems emerges because of the source energy physicalizing its original energy definition as a form of mass independent consciousness and as a function of quantum angular acceleration defined in a space-less void of the mathematical or metaphysical singularity.

The absence of mass or inertia defines the quantum acceleration as the time derivative of frequency as a pure number count not requiring any spatial coordinates or displacements and by necessity relate a frequency distribution as a quantized number field given by particular boundary- and initial conditions, defining a particular form for the frequency distribution once the space coordinates and displacement vectors are added to the frequency distribution at the instanton-inflaton coupling defining the parameters of a Quantum Big Bang redefining the mathematical singularity.

The boundary conditions for the frequency distribution then assume the form of a maximum and a minimum permutation count under an inversion duality and as defined in the T-duality of superstring-membrane theory.

The initial condition for the transformation of the source energy as a metaphysical singularity in null space into displacement coordinate-vector space, then defines a maximum frequency permutation self-state unifying with its minimum frequency permutation state in the form of the time differential for frequency or  $df/dt$ . In the null space of the singularity, the inversion property so defines the maximum frequency state  $f_{\text{max}}$  for a time coordinate  $t_{\text{min}}$  and the minimum frequency state  $f_{\text{min}} = 1/f_{\text{max}}$  with  $t_{\text{max}}$  not defined as a limit or upper bound for a subsequent expansion of the coordinate space emerging from the null space.

The eigen state for the source energy so is defined in a source energy quantum of metaphysical consciousness physicalized in a Quantum Big Bang and because of defining the minimum spacetime configuration in the quantum fluctuation of the mathematical singularity.

This null space so is space-less and without energy as defined in spacetime, but nevertheless carries energy in the form of not physicalized consciousness defined metaphysically or in abstract mathematical terms.

The null space is descriptive of the 12-dimensional universe of the mathimatia and remains not physicalized until the boundary of the 5<sup>th</sup> superstring class has become defined in the physical null space.

The source energy quantum for physicalized consciousness and therefore physicalized energy so is defined as the Weyl-boson of the Quantum Big Bang self-creation event, creating spacetime as the Weyl-wormhole as a transformed superstring class from the first superstring class of a Planck-boson causative and defining the quantum oscillation of itself to manifest the spacetime parameters created in a physicalisation of the Planck-boson as the Weyl-boson at the instanton as the birth of spacetime and coupled to an inflaton as the upper boundary initial condition for the lower boundary as the instanton.

At the instanton  $df/dt|_{\max}=df/dt|_{\text{weyl}}=df/dt|_{\text{primarysourcesink}}=df/dt|_{\text{ps}}=f_{\max}/t_{\min}=f_{\max}^2$  for  $E_{\text{ps}}=E_{\text{weyl}}=hf_{\text{ps}}=hc/l_{\text{ps}}=m_{\text{ps}}c^2=k_B T_{\text{ps}}$

The physicalized energy expressions with unitary mensuration units for the spacetime parameters however emerged from the null space, describing the higher dimensional 'string-membrane' space and this 'definition spacetime' of the 5 string classes preceded the Weyl-boson spacetime in the frequency- or number-space modulating the spacetime parameters and measurement units to define the Weyl-Eps-boson in the units of the Witten spacetime.

$E_{\text{ps}}=E_{\text{weyl}}=\{m_{\text{electron}}/2e\}\sqrt{\{hc/2\pi G_o/hc\alpha\}}|_{\text{mod}}=\{m_{\text{planck}}/m_{\text{electron}}\}/\{2eV\alpha\}|_{\text{mod}}$  and defining the source energy quantum as having units of Inverse electropole charge or  $1/e$  defining a magnetopole charge  $e^*=1/E_{\text{weyl}}$  as the proportionality condition for multidimensional unification  $E_{\text{weyl}} \cdot e^*=E_{\text{ps}} \cdot e^*=1$  and for  $2e/e^*=2e \cdot E_{\text{ps}} = \text{constant} = \{m_{\text{planck}}/m_{\text{electron}}\}/\{V\alpha\} = G_o m_{\text{electron}}/2e^2$ .

In the manifested spacetime from the quantum Big Bang, the magnetopole charge  $e^*$  has the units of the gravitational parameter GM in the form of  $e^*=2R_{\text{electron}}c^2$  in units  $[\text{Volume}][df/dt]=[\text{m}^3/\text{s}^2]$

Using the mass of the electron and the Planck-mass as a dimensionless ratio, the Planck-mass is proportional to the Planck-length in the quantization of quantum angular momentum in  $m_{\text{planck}}=\sqrt{\{hc/2\pi G_o\}}$  with  $L_{\text{planck}}=\sqrt{\{hG_o/2\pi c^3\}}$  in Planck' constant

$G_o m_{\text{planck}}^2/c=h/2\pi=c^3 L_{\text{planck}}^2/G_o$  for the proportion  $m_{\text{planck}}=\{c^2/G_o\}L_{\text{planck}}$  by the generalised finestructure unification  $G_o k_e=1$  from  $2\pi G_o M^2/r^2=2\pi k_e e^2/r^2$  with the Maxwell fine structure  $\mu_o \epsilon_o=\{120\pi/c\}\{1/120\pi c\}$  and the free spacetime impedance  $Z_o=\sqrt{\mu_o/\epsilon_o}=120\pi$ . Here  $G_o=4\pi \epsilon_o|_{\text{mod}}=\{4\pi/120\pi c\}|_{\text{mod}}=1/30c|_{\text{mod}}$ .

The monopole string class so 'unifies' Electromagnetism with Gravitation via the gravitational finestructure assuming not a Weylian fermionic nucleon, but the bosonic monopole from the  $k_e G_o=1$  initial-boundary condition  $G_o m_{\text{Monopole}}^2=k_e e^2$  for

$$m_{\text{Monopole}}=e/G_o=k_e e=[30ec]_{\text{mod}}=m_{\text{planck}} \cdot \sqrt{a}.$$

The 'Grand-Unification' magnetic monopole mass so becomes  $[30ec]_{\text{mod}}c^2=30ec^3 \text{ eV}^*$  for a magnetic monopole mass of  $8.1 \times 10^{17} \text{ GeV}^*$  manifesting in Weyl-spacetime as a defect in the Higgs-boson symmetry, breaking a SU(3)SU(2)U(1) gauge symmetry in the supersymmetry of a SU(5) string-membrane spacetime.

The Higgs-boson, as a universal mass generator from its quantum geometric template; so, manifests the magnetic monopole as a magnetic point charge, manifesting in a magneto-current mass equivalence in the modulation of

$$[ec]_{\text{mod}} = [\text{monopole mass } m_{\text{monopole}}] = [\text{monopolar current } i_{\text{monopole}}] \\ = [\text{electropolar charge } e] \times [\text{displacement/time}]$$

and where the displacement of the magnetic point charge occurs in the string modular space of the 'bounce' of the Planck-Length as the oscillation of a Zero-Point Planck-boson oscillator defining the minimum spacetime configuration of superstring class one transforming into superstring class 2 as the Monopole-boson and manifesting the quantum Big Bang in superstring class 5 at the instanton-inflaton coupling, creating spacetime in the Weyl-boson and the inflaton.

The quantum fluctuation of the Planck-boson is defined in the 'bounce' of the Planck length as

$$L_{\text{stoney}} = \sqrt{\alpha} \cdot L_{\text{planck}} = \sqrt{\{2\pi k_e e^2 / hc\}} \cdot \sqrt{\{hG_o / 2\pi c^3\}} = \sqrt{\{k_e G_o e^2 / c^4\}} = e / c^2.$$

And modulate the string displacement of the 'Planck bounce' as the ratio of electropole charge to the square of the speed of light. Substituting  $L_{\text{stoney}}$  for the mass-current equivalence of the magnetic monopole  $[ec]_{\text{mod}} = [\text{mass}] = [\text{monopolar current} / \text{Stoney displacement}] = [ec / (e/c^2)] = [c^3]_{\text{mod}}$  as the energy of monopole  $[ec]$  as a mass in  $c^3 = 2.7 \times 10^{16} \text{ eV}^*$ .

A monopole mass of  $[ec]_{\text{mod}} = 4.818 \times 10^{-11} \text{ kg}^*$  or  $2.7 \times 10^{16} \text{ GeV}^*$  so is upper bounded by the monopole string as a Higgs defect of  $8.1 \times 10^{17} \text{ GeV}^*$  and a factor of 30.

The proportionality constant in units' mass/displacement  $[\text{kg}/\text{m}]$  describes Maxwell's displacement current in the non-inertial reference of the Stoney units of the transformation of the Planck string into the Stoney monopole string.

As the Planck string suppresses the parameter of electric charge 'e' in the Planck displacement or Planck length  $L_{\text{planck}} = \sqrt{\{hG_o / 2\pi c^3\}}$  and Planck mass  $m_{\text{planck}} = \sqrt{\{hc / 2\pi G_o\}}$  and the Planck time

$$t_{\text{planck}} = L_{\text{planck}} / c = \sqrt{\{2\pi G_o h / c^5\}} \text{ with the Planck energy } E_{\text{planck}} = m_{\text{planck}} \cdot c^2 = h / t_{\text{planck}} \text{ and Planck temperature}$$

$T_{\text{planck}} = E_{\text{planck}} / k_B = \sqrt{\{hc^5 / 2\pi G_o k_B^2\}}$  from Newton's law for gravitational force  $F_{\text{grav}} = G_o Mm / R^2$ , and from Coulomb's law for electric force  $F_{\text{emr}} = k_e e^2 / R^2$ .

This defines a Planck charge  $q_{\text{planck}} = \sqrt{\{hc / 2\pi k_e\}} = \sqrt{\{2\varepsilon_o hc\}} = e / \sqrt{\alpha}$  for a Coulomb electric permittivity constant  $\varepsilon_o = 1 / m_o c^2$  and a magnetic permeability constant  $\mu_o$  from the Maxwell equations for classical electromagnetism and the electromagnetic finestructure constant  $\alpha = 2\pi k_e e^2 / hc$ .

The electromagnetic finestructure constant alpha  $\alpha$  so becomes the agency to transform the Planck units into Stoney units. The Stoney string suppresses the Planck- and Action constant 'h' in the Stoney length  $L_{\text{stoney}} = \sqrt{\{G_o k_e e^2 / c^4\}}$  and a Stoney mass  $m_{\text{stoney}} = \sqrt{\{k_e e^2 / G_o\}}$  and the Stoney time  $t_{\text{stoney}} = \sqrt{\{G_o k_e e^2 / c^6\}}$  with Stoney energy  $E_{\text{stoney}} = m_{\text{stoney}} \cdot c^2 = h / t_{\text{stoney}}$  and Stoney temperature  $T_{\text{stoney}} = E_{\text{stoney}} / k_B = \sqrt{\{k_e e^2 c^4 / G_o k_B^2\}}$ .

This defines a Stoney charge  $q_{\text{stoney}} = e$  as the Coulomb charge quantum and defines Planck's constant  $h = 2\pi k_e q_{\text{planck}}^2 / c = 2\pi k_e e^2 / c = 2\pi k_e q_{\text{stoney}}^2 / c = \alpha h$  for a unitized finestructure constant being 1 in Stoney units but being about 1/137 in Planck units using the numerical values for the constants of nature defined in the symbols of the Mathimatia.

The proportionality constant for the unification of the electromagnetic and gravitational forces or energy interactions so is obtained in the ratio of the Stoney mass to the Stoney displacement or  $m_{\text{stoney}}/L_{\text{stoney}} = \sqrt{\{(k_e e^2/G_0)/(G_0 k_e e^2/c^4)\}} = \sqrt{\{c^4/G_0^2\}} = c^2/G_0$  and the same ratio of the Planck mass to the Planck length in

$$m_{\text{planck}}/L_{\text{planck}} = \sqrt{\{(hc/2\pi G_0)/(hG_0/2\pi c^3)\}} = \sqrt{\{c^4/G_0^2\}} = c^2/G_0.$$

Maxwell's mass displacement current for the 'flow of inertia' so is quantum gravitationally expressed in the constant  $c^2/G_0$  and where Newton's gravitational constant  $G$  is applied to an inertia free or massless universe defined in a curvature of 'free space' for the Maxwell definition for the invariance of the speed of light and propagation of electromagnetic waves and in the formulation  $\mu_0 \cdot \epsilon_0 = 1/c^2$  and fine structured in the 'free space impedance'  $Z_0 = |\text{Electric Field Strength } \mathbf{E}| / |\text{Magnetic Field Strength } \mathbf{H}| = \sqrt{\{\mu_0/\epsilon_0\}} = \sqrt{\{(120\pi/c)/(1/120\pi c)\}} = 120\pi$ .

In an inertia free universe without mass, the curvature would become independent on mass and the displacement parameter would be given in the Stoney length  $L_{\text{stoney}} = \sqrt{\{G_0 k_e e^2/c^4\}}$  and where the curvature would be defined in the proportionality constant  $\sqrt{\{G_0 k_e\}}$  in units of  $\sqrt{\{[Nm^2/kg^2][Nm^2/C^2]\}} = \sqrt{\{m^6/s^4 \cdot C^2\}} = [m^3/s^2 C]$  and so the units of the gravitational parameter  $GM$  divided by the units of Coulomb charge 'e' and the units of spacetime awareness multiplied by the units of a spacetime volume divided by the units of the charge 'e'.

The quantum physics of this formulation enables the Logos mathimatia to unitize both the gravitational parameter  $GM$  and the consciousness quantum (proportionality constant)  $V_{\text{weyl}} \cdot \{df/dt\} = 1/e^*$  in a definition of  $e^*$  being the magnetopolar charge as inversion of the quantum energy formulations  $E = hf = mc^2 = k_B T$ . Instead of the unit for electropolar charge using the Coulomb [C], the magnetopolar charge uses the Star Coulomb [C\*] as the unit of measurement.

This unitization of the units of the Stoney length in the Star Coulomb also unitizes the product of the proportionality constant in the Stoney length as  $G_0 k_e = 1$  and therefore unifies the energy interactions of gravitation and electromagnetism on the quantum level of the source energy.

This also redefines the Stoney length as  $L_{\text{stoney}} = \sqrt{\{G_0 k_e e^2/c^4\}} = L_{\text{stoney}} = \sqrt{\{e^2/c^4\}} = e/c^2 = L_{\text{stoney}} = \sqrt{\alpha} \cdot L_{\text{planck}} = \sqrt{\{2\pi k_e e^2/hc\}} \cdot \sqrt{\{hG_0/2\pi c^3\}} = \sqrt{\{k_e G_0 e^2/c^4\}} = e/c^2$ . The Stoney length  $e/c^2$  in the units of displacement of the Planck length, so represents the quantum fluctuation causative for the Quantum Big Bang and the separation of the old heaven from the old earth in a factor of the inverse of the square root of alpha or a numerical factor of about  $11.706 = 1/0.0854$  describing the oscillation of the Planck length between a linear displacement value of  $\{e/c^2 = 1.784 \times 10^{-36} \text{ m}^*\}$  and  $\{\sqrt{\{hG_0/2\pi c^3\}} = 2.090 \times 10^{-35} \text{ m}^*\}$  in star units derived from the free space impedance where the speed of light is precisely  $3 \times 10^8 \text{ [m/s]}^* = 2.99792458 \times 10^8 \text{ [m/s] SI}$ .

A fundamental natural law multidimensional universe crystallizes from the definition of the 'free space impedance'  $Z_0 = |\mathbf{E}/\mathbf{H}| = \sqrt{\{\mu_0/\epsilon_0\}} = \sqrt{\{(120\pi/c)/(1/120\pi c)\}} = 120\pi$  in the unitary analysis:

$Z_0 = \sqrt{\{(H/m)/(F/m)\}} = \sqrt{\{[Js^2/C^2 m]/[C^2/Jm]\}} = [Js]/[C^2] = [\text{Action}/\text{Charge}^2]$  in Ohms  $[\Omega] = [V/I] = [Js/C^2]$  and proportional to  $[h/e^2]$  as the 'higher dimensional source' for the manifesting superconductivity of the lower dimensions in the quantum Hall effect ( $\sim e^2/h$ ), the conductance quantum ( $2e^2/h$ ) and the Josephson frequencies ( $\sim 2e/h$ ) in Ohms  $[\Omega]$ .



## Universal Communication between Consciousness Carriers as a function of Wien's Law and the 9-micron infrared atmospheric window on earth

A crucial point in the quest to lift the veil on the consciousness debate is Wien's law, relating the human body as a EMR emitter to the universal energy matrix.

The importance of the Fibonacci series as linked to the electromagnetic finestructure constant alpha and its relationship to the fundamental Goldstone interactions is indicated by Wien's Law as an approximation to Planck's Law of Radiation and the Black Body spectra.

Models for physicalized consciousness then point to a physics of harmonic vibrations and frequencies.

The Black Body Radiation spectrum of the human body peaks at about 300-310 Kelvin in the near infrared.

Wien's law then infers a wavelength of 9-10 microns for this temperature:

Wavelength peak =  $0.002897/\text{Temperature}$ , measured in meters.

The Quantum Big Bang temperature  $T_{ps} = T_{weyl} = T_{wormhole} = hc/k_B\lambda_{ps} = 1.41671 \times 10^{20} \text{ K}^*$  manifests as a initializing/boundary parameter to trigger the temperature gradient for the so called 'False Higgs Vacuum' with the quantum form forcing the universe's spacetime expansion from its algorithmic form of the timespace of the Dirac string transformation centered on the Dirac monopole and the wormhole wavelength and frequency modulating the linear radian form of the Planck length into its trigonometric circular form.  
- (PDF) [Quantum Consciousness in the Penrose-Hameroff Model | Anthony P Bermanseder - Academia.edu](#)).

From the Planck-Radiation-Law, the exponential energy ratio:

(Planck-Law/Stefan-Boltzmann Law) =  $hf/k_B T = hc/\lambda k_B T$ , the quantum form for Wien's Law defines the Wien constant  $b^* = hc/k = 0.0141671$  as being bounded in  $\sqrt[3]{\alpha} = F(S) = \# = 0.19395906$  as the Strong Interaction Constant normalized to Unity 1 in a Unification Polynomial:

$(1-X)(X)(1+X)(2+X) = 1$  or  $X^4 + 2X^3 - X^2 - 2X + 1 = 0$  and is used to find the coupling ratios between fundamental interactions:  $f(S) \mid f(E) \mid f(W) \mid f(G) = \# \mid \#^3 \mid \#^{18} \mid \#^{54}$  from the proportionality  
 $\# \mid \#^3 \mid \{(\#^3)^2\}^3 \mid \{(\{(\#^3)^2\})^3\}^3 = \text{Cube root}(\text{Alpha}) : \text{Alpha} : \text{Cuberoot}(\text{Omega}) : \text{Omega}$ .

The Gravitational finestructure, here named Omega, is further described by a five folded supersymmetry of the string hierarchies, the latter as indicated in pentagonal or five folded super symmetry characterized by the Fibonacci-Lucas Series.

This pentagonal supersymmetry can be expressed in several ways, say in a one-to-one mapping of the Alpha finestructure constant as invariant X from the Euler Identity:  $X+Y = XY = -1 = i^2 = \exp(i\pi)$ .

The Unification polynomial then sets the ratios in the inversion properties under modular duality:

$(1)[\text{Strong short}] \mid (X)[\text{Electromagnetic long}] \mid (X^2)[\text{Weak short}] \mid (X^3)[\text{Gravitational long}]$  as  
 $1 \mid X \mid X^2 \mid X^3 = (1-X) \mid (X) \mid (1+X) \mid (2+X)$

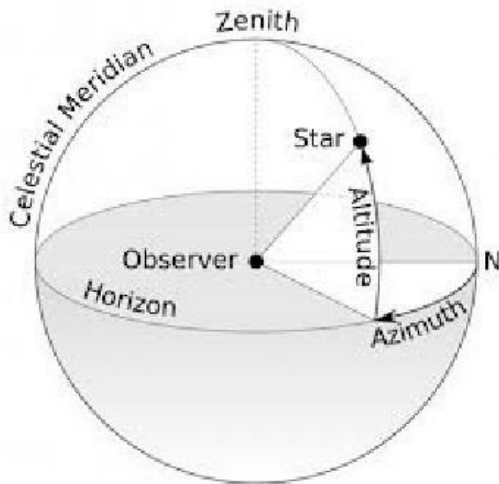

24 Hours = 360°  
 1 Hour (h) = 15°  
 1 Minute (m) = 15'  
 1 Second (s) = 15''

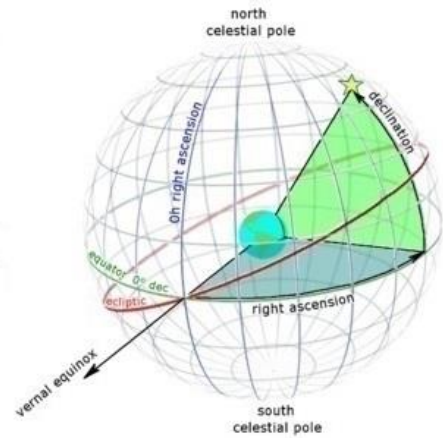

A Spherical Bubble of Diameter  $R_{\text{Sirius}}=8.5828$  lightyears will have its Center in the Centauri System at  $R_{\text{Centauri}}=4.2914$  lightyears and as observed relative to an observer from the Earth as the distance between Sirius and Gaia-RahSol say as the Northpole and the Southpole of this spherical bubble.

A message sent from Sirius to the RahSol receiver so will effectively encompass the journey of the same data stream between Sirius and the Centauri midpoint, as well as a roundtrip between Gaia-RahSol and the Centauri star system in a lightpath between 8½ and 9½ years.

**Centauri Starsystem:** {0.4011+0.5989=1 for Proxima-Nexus-Alpha}

Distance= $R_{\text{Centauri}}=4.2421 - 4.2914 - 4.3650$  lightyears  
 Right Ascension:  $\alpha=14\text{h } 29\text{m } 43.0\text{s} - 14\text{h } 33\text{m } 41.05\text{s} - 14\text{h } 39\text{m } 36.5\text{s}$   
 $=217^\circ 25' 45'' - 218^\circ 25' 15.7'' - 219^\circ 54' 7.5''$   
 Declination:  $\delta = -62^\circ 40' 46'' - -61^\circ 56' 21'' - -60^\circ 50' 02''$

**Sirian Starsystem:**

Distance= $R_{\text{Sirius}}=8.5828$  lightyears  
 Right Ascension:  $\alpha=06\text{h } 45\text{m } 08.9\text{s} = 101^\circ 17' 13.5''$   
 Declination:  $\delta=-16^\circ 42' 58''$

Given the spherical  $(\alpha, \delta, R)$  coordinates of a star, the corresponding rectangular  $(X, Y, Z)$  coordinates may be computed from:

$$X = R \cdot \cos(\alpha) \cdot \cos(\delta)$$

$$Y = R \cdot \sin(\alpha) \cdot \cos(\delta)$$

$$Z = R \cdot \sin(\delta)$$

Because by the Pythagorean Theorem:  $x^2+y^2+z^2=R_{\text{Star}}^2$  for  $x=r\cos\alpha$ ,  $y=r\sin\alpha$  and  $z=R_{\text{Star}}\cos(90^\circ-\delta)=R_{\text{Star}}\sin\delta$  for  $\cos\delta=\sin(90^\circ-\delta)=r/R_{\text{Star}}$  for  $x^2+y^2=r^2$

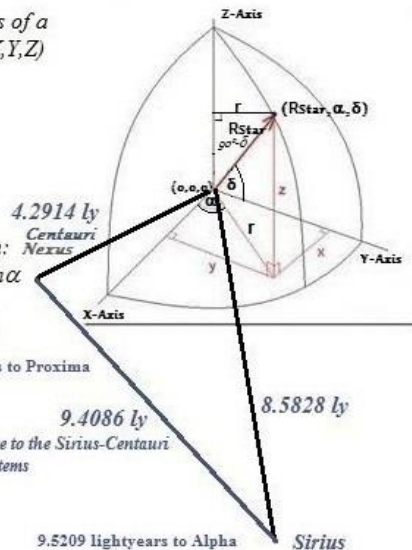

$$\text{Sirius} = (X, Y, Z) = (-1.6089; 8.0611; -2.4687)$$

$$\text{Centauri min} = (X, Y, Z) = (-1.5461; -1.1833; -3.7689)$$

$$\text{Centauri mid} = (X, Y, Z) = (-1.5816; -1.2545; -3.7869)$$

$$\text{Centauri max} = (X, Y, Z) = (-1.6319; -1.3646; -3.8116)$$

$$\sqrt{(dx^2+dy^2+dz^2)}=\sqrt{(0.003944+86.7804+1.7377)}$$

$$=\sqrt{88.522}=9.4086$$

**The expanding 'New Earth' star-planetary bubble for physicalised ET contact**

4.2914 lightyears = 1567.36 days as April 6th, 2017  
 8.5828 lightyears = 3134.72 days as July 21st, 2021  
 9.4086 lightyears = 3436.14 days as May 19th, 2022

all from December 21st, 2012 with 4 years = 1461 days

From December 21st, 2012 then Gaian data is travelling at lightspeed towards all possible ET receivers in the universe.

4.2914 lightyears or 1568 days from this warzone initiation date then calculate the time for 'first contact' of the Gaian information received by the 'nearest' Centauri starsystem.

This becomes calendar star date: April 7th, 2017 and 107 days from December 21st, 2016

8.5828 lightyears or 3135 days from this warzone initiation date then indicate the reception by the Sirian starsystem.

This becomes calendar star date: July 22nd, 2021 and 213 days from December 21st, 2020

9.4084 lightyears or 3437 days from this warzone initiation date then define the timeperiod of communication between the Centauri and the Sirian starsystem in the 4D-spacetime universe embedded within the 12D creator-creation energy matrix.

This becomes calendar star date: September 4th, 2026 and as 3437 days from April 7th, 2017

Using the lower dimensional method of information transmission at lightspeed; 'first contact' between Gaia and the extraterrestrial cosmos so requires the expansion of the Gaian 'data starplanet bubble' to intersect the habitated zone of the nearest starsystem in the Centauri starsystem. It is then, the coevolution of the 'Centurians' will be able to 'densify' and physicalise its own evolution from its 5D timespace into its seedling 4D timespace and as universally defined in its Hill-Spheroidal gravitational harmonisation between say a civilization harbouring planet with its hosting star.

Then the entire planetary history of Gaia can be shared and used as data base by the Centaurians to observe and apply the experience of Earth in constructive and destructive modes of operation. This includes the manner and methods of governance and cultural interactions of how not to construct a galactic civilization. The Gaian cosmic experience therefore will become a template and blueprint accessible by ET agencies in fashions of exemplar, illustration and a means for comparison in evidence.

The reception of the Gaian data base upon download in a Centauri information storage utility will however enable the 5D spacetime matrix civilization to apply its higher dimensional hyperphysics of monopolar 'consciousness based' electromagnetic radiation transmission to teleport its then memorized data bank in various extent to Centaurian 'motherships' and 'observer stations' which are already within the Gaian data bubble, say within the solar system of Rahsol.

From April 2017 in earth based calendrical reckonings of time, defined by lightspeed 'c'; any ET observer in appropriate vicinity within the Hill-Sphere of Gaia and so within 2 million kilometers from the center of the Earth; will become privvy to any directive and directive from their planetary homebase and so will be authorised to follow those directives in various contact scenarios between the Centaurians and the Gaian lifeforms, inclusive of all exiled familiars of the Centaurian coevolution, which had experienced the history upon Gaia in forms of archetypes and lifeforms native to Gaia, such as the lifeforms of the Equidae evolution symbolising the starry legacy of Gaian mythology and legends and individualising in genus so 50 million years ago in Eocene epochian paleogenomic taxonomy, such as the 'extinct' Eohippus.

This 'extinction' from the Gaian fauna however describes a 'transmigration' of the Centaurian consciousness in cosmic or universal terms to allow the higher dimensional hyperphysical or 'electromagnetically morphed' civilization to utilize the experience of itself in the lower physicalised and densified form in the parameters of the universal definition for consciousness as an effect and characteristic of 'spacial occupancy'.

All lifeforms upon Gaia are data processors for the universe and their ET civilizations occupying higher D spacetime and lower D spacetime simultaneously in temporary separation for the purpose to utilize their common Gaian 'Universal Mother' at a time the planetary cosmic mother can release their shared information to communicate interdimensionally and end the Gaian quarantine.



$\lambda^* = F(S)b^* = \#hc/k_B = \sqrt[3]{\alpha} hc/k_B = 2.74784 \times 10^{-3} \text{ m}^* = \{0.94694\} 2.9018 \times 10^{-3} \text{ m}^*$  and therefore differing from Wien's b constant by 5.3 % as the Baryonic Matter saturation approximation for the total energy content of the universe, using Star units (\*) for  $1 \text{ m}^* = 0.998331431 \text{ m}_{SI}$ .

The present Baryonic matter content is  $BM=4.834\%$  with Dark (Restmass Photonic) Matter at  $DM=27.434\%$  and with a Dark Energy component of  $DE=67.73\%$  according to Quantum Relativistic cosmology.

The Baryonic Matter saturation coordinate is given in the cyclic monopolar EMR light path from the positively curved de Sitter cosmology (in 11 quantum gravitational dimensions) intersecting the linear expanding Planck-Black-Body Radiator Cosmic-Microwave-Background-Radiation light path of the negatively curved Anti de Sitter cosmology (in 10 string dimensions) subject to universal gravitation.

$BM=5.55\%$  with  $DM=22.09\%$  with  $DE=72.36\%$  for cycle coordinate  $n'=2-\sqrt{2}=0.585786$  and  $n=2-n'=\sqrt{2}$  or 23.866 G-years after the creation event and  $23.87-19.12=4.75$  billion years from the present time.

The baryonic matter component evolves according to  $\Omega_{BM}=\Omega_o Y^n = 0.02803\{1.618034\}^{1.132712} = 0.0483$  until saturation coordinate for the baryonic matter BM intersecting dark matter DM for  $n=\sqrt{2}$  for  $\Omega_{BM}=\Omega_o Y^n = 0.02803\{1.618034\}^{\sqrt{2}} = 0.055357 = \text{constant}$  for the cosmic matter evolution from 23.866 Gy.

The dark matter  $\Omega_{DM} = 1-\Omega_{BM}$  until onset of the dark energy component DE at  $n=1/2$ , from which  $\Omega_{DM}$  is calculated by  $\Omega_{DM}=\Omega_{BM}\{[1+1/n]^3 - 1\}$  and as 0.27434 for the present time.

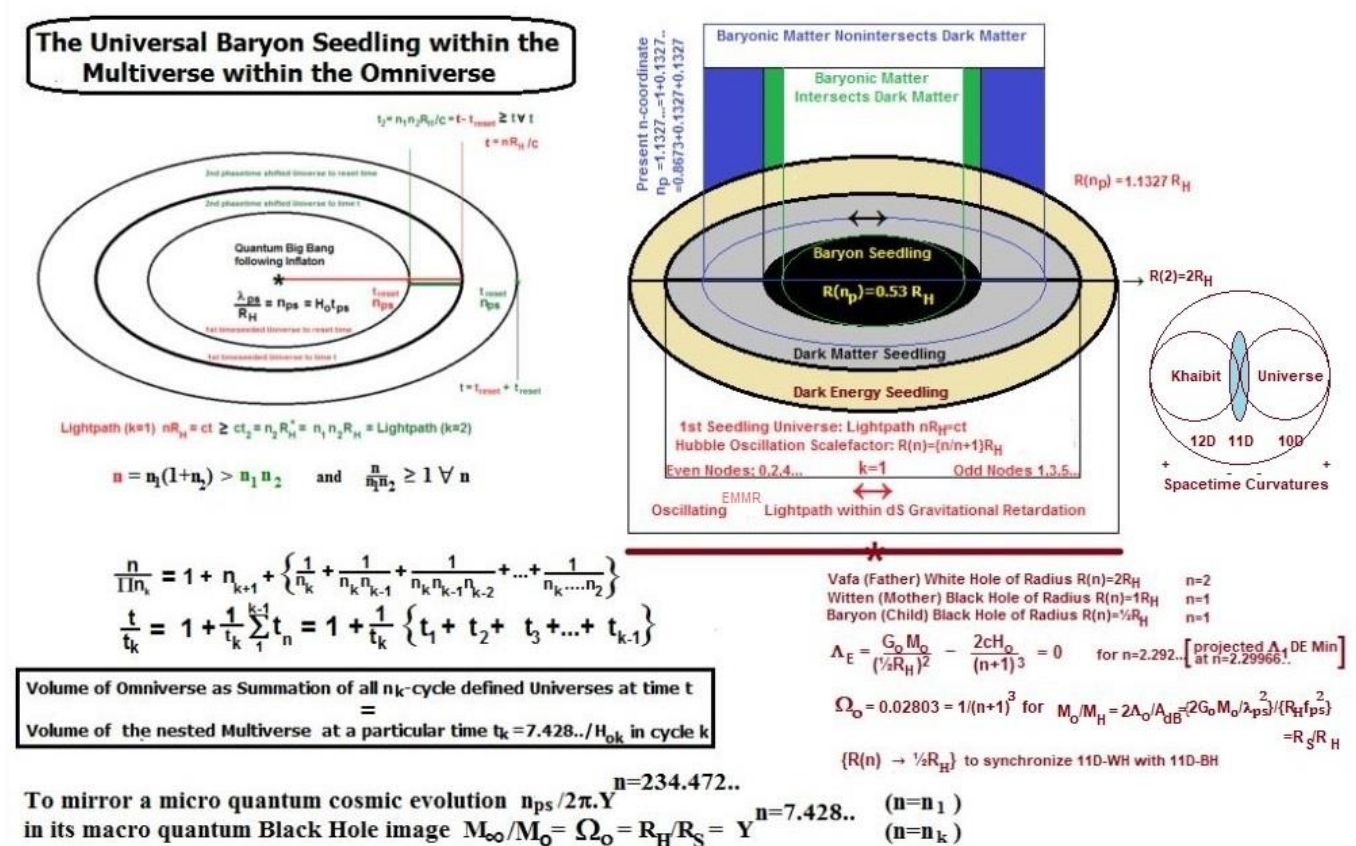

"The idea of an antigravity force has had a bad rep ever since," says Kirshner. "People sort of stammered when it was mentioned, usually because it meant they couldn't explain their results." So when Riess, having checked his figures, suggested this might be the reason he kept showing negative mass, Kirshner, in quiet desperation, emailed the whole team, saying, "In your heart of hearts, you know this can't be right! We have got to find out where the error is."

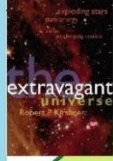

"In your heart you know this is wrong." Really, it just seemed like a terrible result, a horrifying thing

GETTING IT RIGHT 219  
the writing assignments. So we all gave him advice. Conflicting advice. After all, this was a collaboration, not an army. I didn't like the result. I didn't think we were smarter than Einstein and he had tripped on the cosmological constant. I did not want to make a mistake. I hadn't liked being wrong about the progenitor of SN 1987A and I did not want to be wrong about the history of cosmic expansion. On 12 January 1998 (at 10:18:31 a.m.) I wrote,

I am worried that the first cut looks like you might need some lambda. In your heart, you know this is wrong, though your head tells you (but) you don't care and you're just reporting the observations... It would be very silly to say "we MUST have nonzero lambda" only to retract it next year.

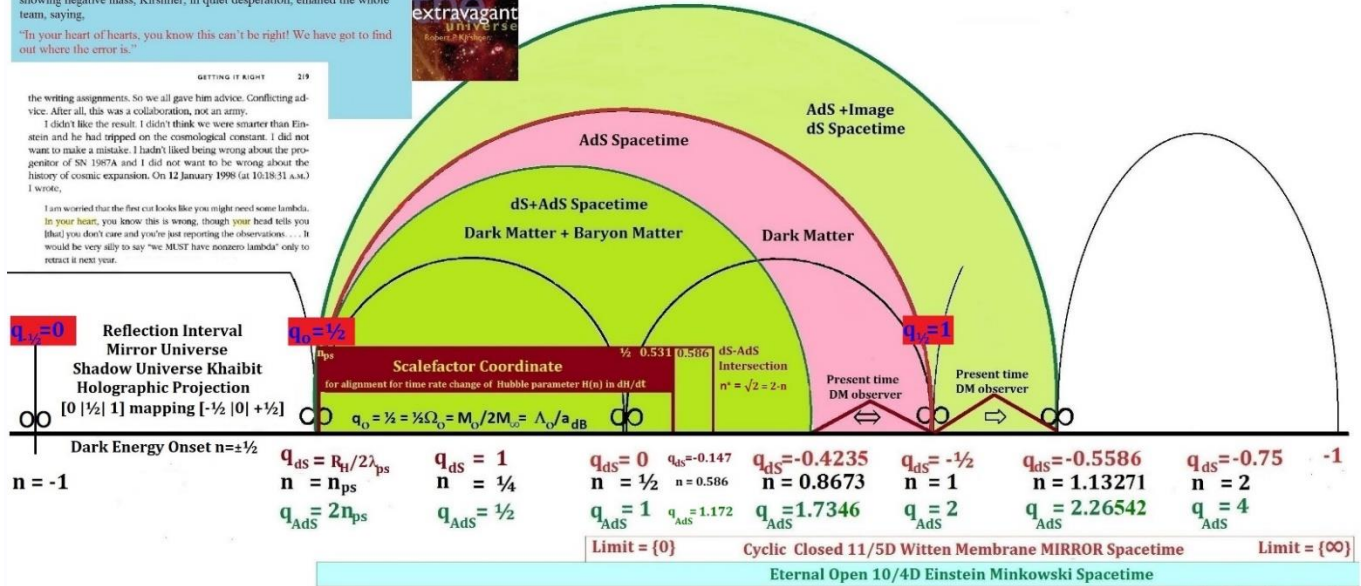

Deceleration Parameter  $q(n) = -\{d^2a/dt^2\}/\{da/dt\}^2$   
 $q_{AdS}(n) = \{-2cH/[n+1]\}^2 \{nR_0/[n+1]\} / \{c/[n+1]\}^2 = 2nH_0R_0/c = 2n$   
 $q_{AdS}(n) = 1/q_{AdS} - 1 = 1/2n - 1 = (1-2n)/2n$

$$q_{ds} = 1/2n - 1$$

$$q_{AdS} = 2n$$

Continuity in Cyclic Resets of the Initial-Boundary parameters

$$\Lambda(n) = G_0 M_0 / R(n)^2 - 2cH_0 / [n+1]^3$$

$$\Lambda(n)/R(n) = G_0 M_0 / R(n)^3 - 2H_0^2 / [n+1]^2$$

$$-P(n) = \frac{M_0 c^2}{R(n)^3} - \frac{(2n+1)c^2 H_0^2}{4\pi G_0 T(n)^2}$$

$$q_{ds} \cdot q_{AdS} = 2n(1/2n - 1) = 1 - 2n$$

$$\frac{q_{ds} + q_{AdS}}{q_{ds} - q_{AdS}} = \frac{1 - 2n + 4n^2}{1 - 2n - 4n^2} = \frac{4\{n-1/4(1+i\sqrt{3})\} \cdot \{n-1/4(1-i\sqrt{3})\}}{-4\{n-1/4(1-\sqrt{5})\} \cdot \{n-1/4(1+\sqrt{5})\}}$$

{ $q_{ds} \pm q_{AdS}$ } are  $1/2$  roots for  $T(n)=1$  in  $n(n+1)+1=0$   
 $n = -1/4(1+i\sqrt{3})$ ;  $n = -1/4(1-i\sqrt{3})$   
 { $q_{ds} q_{AdS}$ } are  $1/2$  roots for  $T(n)=-1=i^2$  in  $n(n+1)-1=0$   
 $n = 1/4(\sqrt{5}-1) = 1/2X$ ;  $n = -1/4(\sqrt{5}+1) = -1/2Y$

The cosmological observer is situated simultaneously in 10/4D Minkowski Flat dS spacetime, presently at the  $n=0.8676$  cycle coordinate and in 11/5D Mirror closed AdS spacetime, presently at the  $n=1.1327$  coordinate.

Observing the universe from AdS will necessarily result in measuring an accelerating universe; which is however in continuous deceleration in the gravitationally compressed dS spacetime for deceleration parameter  $q_{AdS}=2n$ . Gravitation is made manifest in the dS spacetime by Graviton strings from AdS spacetime as Dirichlet branes at the 10D boundary of the expanding universe mirroring the 11D boundary of the nodally fixed Event Horizon characterised by  $H_0 = c/R_H$

The Dark Matter region is defined in the contracting AdS lightpath, approaching the expanding dS spacetime, but includes any already occupied AdS spacetime. The Baryon seeded Universe will intersect the 'return' of the inflaton lighpath at  $n=2-\sqrt{2}=0.586$  for (DM=22.09%; BM=5.55%; DE=72.36%).

The Dark Energy is defined in the overall critical deceleration and density parameters; the DE being defined in the pressure term from the Friedmann equations and changes sign from positive maximum at the inflaton-stanton to negative in the interval  $\Lambda(n)>0$  for  $n$  in  $[n_{ps} - 0.18023]$  and  $\Lambda(n)> 3.4008$  with  $\Lambda(n)<0$  for  $n$  in  $(0.1803 - 3.4008)$  with absolute minimum at  $n=0.2389$ .

This DE (quasi)pressure term for the present era (1-0.1498 for 85% DM of Matter 4.834% BM; 27.434% DM; 67.732% DE) is  $\Lambda_p = -1.4004 \times 10^{-10} \text{ J/m}^3 < 0 \neq n$  and is integrated into a Lambda quintessence of  $1.039 \times 10^{-36} \text{ s}^{-2}$  and from  $\Lambda(n_p) = -8.815 \times 10^{-11} \text{ m/s}^2$

This pressure term will become asymptotically negative for a universal age of about 57.4 Gy and for a zero curvature evolution of the cosmos within the multiverse generations.

The dimensionless acceleration ratio  $q_0 = \Lambda_0/A_{dB} = M_0/2M_H = 1/2\Omega_0$  assumes the value  $q_0 = 1/2$  for  $n = 1/3$  and when the radial size of the universe is at halfway nexus at  $1/4 R_H$  for the intersection coordinate between the AdS lightspeed invariant expansion and the Dark Energy onset at redshift  $z = 0.6124$  for the dS gravitationally retarded cosmology and for  $R(1/2) = 1/2 R_H/[1+1/2] = 1/3 R_H$

At the instanton  $t_{ps}$ , a de Broglie Phase-Inflation defined  $r_{max} = a_{dB}/f_{ps}^2$  and a corresponding Phase-Speed  $v_{dB} = r_{max} \cdot f_{ps}$ . Those de Broglie parameters constitute the boundary constants for the Guth-Linde inflation and the dynamical behaviour for all generated multiverses as subsets of the omniverse in superspacetime CMF.

Initially, the de Broglie Acceleration of Inflation specified the overall architecture for the universe in the Sarkar Constant  $A_S = A_E(n_{ps}) r_{max} / a_{dB} = G_O M_O / c^2$ . The Sarkar Constant calculates as 72.4 Mpc,  $2.23541620 \times 10^{24}$  m or as 236.12 Mlightyears as the bounding gravitational distance/scale parameter.

A Scalar Higgsian Temperature Field derives from the singularity and initialises the consequent evolution of the protocosmos in the manifestation of the bosonic superbranes as macroquantisations of multiverses in quantum relativistic definitions.

The Omega of critical density is specified in acceleration ratio  $A_E(n_{ps})/a_{dB}$ , which is  $G_O M_O / c^2 r_{max} = 0.01401506 = \frac{1}{2} M_O / M_\infty = \frac{1}{2} \Omega_O = q_O$  (Deceleration Parameter).

$$\frac{2G_O M_O}{c^2} \frac{2c^2}{R_H^2} = \frac{4c^2 G_O M_O}{R_H R_H c^2} = \Omega_O 2cH_O \quad \Omega_O = 0.02803$$

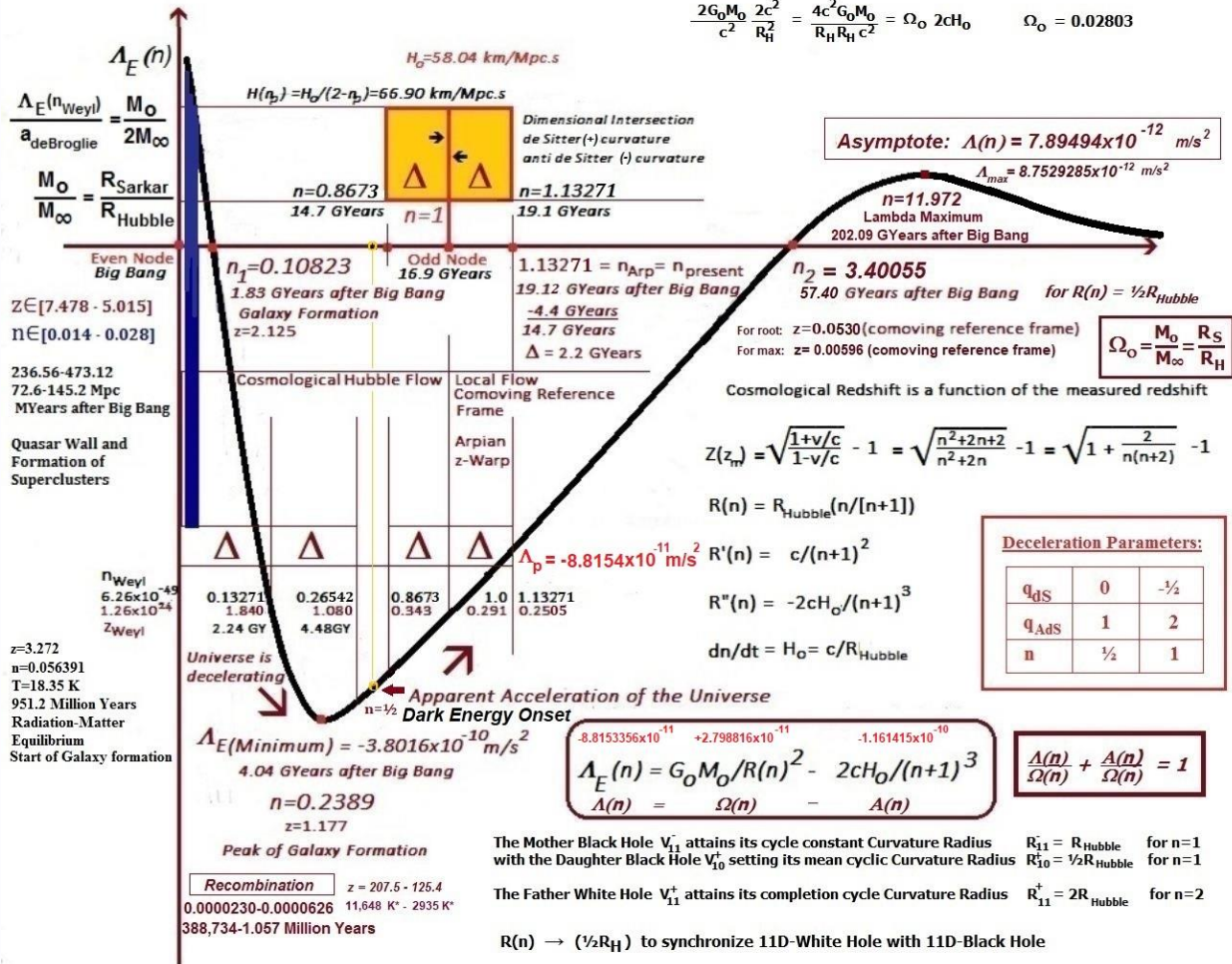

The atmospheric window for life on earth is also at 9 microns, allowing universal communication for the frequency spectrum given by the human body and other lifeforms to actually communicate its collective planetary consciousness to the cosmos.

Water vapor does not absorb in this window between about 8-14 microns and has a peak at about 9.6 microns for an Ozone-Greenhouse absorption nexus and for a body temperature of 302 Kelvin or so 28 degree Celsius.

So life on earth communicates with the universe through its infrared EMR emission as Black Body Radiators, both collectively and individually.

Those physical facts can then be used in models of consciousness using toroidal geometries, say from biochemical principles and from the viewpoint of universal genesis.

In universal genesis, the wormhole frequency of all creation, derived from the Dirac string cosmology defines a wavelength of  $10^{-22}$  meters in the 'quantum of universal consciousness' given in units of the gravitational parameter GM as {volume} $\times$ {angular acceleration} or {volume} $\times$ {frequency squared}.

But those units define both the dipolar electric Coulomb charge and the magnetic monopolar Dirac charge in the T-string duality and the  $c^2$  invariance:  $e=(\text{Planck-Length})\times(c^2)$  conformally mapped onto  $e^*=(\text{Electron Diameter})\times(c^2)$ .

Wien's Law is recovered in the consciousness quantum by  $(\text{wormhole wavelength})\times(c^2) = 9$  microns as the universal consciousness parameter manifested in the gravitational parameter GM and so the fundamental nature of mass as an expression of the minimum frequency configuration of the universal monopolar EMR spectrum with the wormhole frequency of the creation event as its maximum.

An electromagnetic cosmology based on string parameters can be said of preceding the introduction of inertial mass in the quantum Big Bang and defines an intrinsic curvature within the higher dimensional (de Sitter) universe based on gravitational mass equivalents and their superconductive monopolar current flows.

This derivation so indicates an electromagnetic cosmology based on string parameters as preceding the introduction of inertial mass in the quantum Big Bang and defines an intrinsic curvature within the higher dimensional (de Sitter) universe based on gravitational mass equivalents and their superconductive monopolar current flows.

A massless, but monopolarly electromagnetic de Sitter universe would exhibit intrinsic curvature in gravitational mass equivalence in its property of closure under an encompassing static Schwarzschild metric and a Gravitational String-Constant  $G_o=1/k_e$  as given in the Maxwellian finestructures in the string space and as  $k_e=1/4\pi\epsilon_o=120\pi c/4\pi=[30c]_{\text{mod}}=1/G_o$  in the finestructure unification condition of  $G_o k_e=1$ .

In other words, the Big Bang manifested inertial parameters and the matter content for a subsequent cosmic evolution in the transformation of gravitational 'curvature energy', here called gravita as precursor for inertia into inertial mass seedlings; both however described by the physics of black holes and the associated Schwarzschild metrics in the unified quantum energy law:

$$\text{Energy } E = mc^2 = hf$$

$$E = hf \text{ (Planck) iff } m = m_0 = 0$$

This manifests the lower dimensional observational matter-energy expressions and a frequency quantization for mass  $m$

Energy  $E = mc^2$  (Einstein) iff  $f = f_{ss} = 1/f_{ps}$  for  $m_0 = \sum m_{ss} = \{h/c^2\} \sum f_{ss}$  for the mass-frequency quantization with  $E_{ps} = hf_{ps} = hc/\lambda_{ps} = m_{ps}c^2 = k_B T_{ps} = 1/e^*$  with the SourceSink Energy – SinkSource Energy Coupling:  $E_{ps} \times E_{ss} = h^2$  and  $E_{ps}/E_{ss} = f_{ps}^2 = 1/f_{ss}^2$  as a Permutation Frequency Eigenstate Counter

The Gravitational Finestructure so derives in replacing the Planck-Mass  $m_{planck}$  by a proto-nucleonic mass:  $m_c = \sqrt{hc/2\pi G_0} \cdot f(\alpha) = f(\alpha) \cdot m_{planck}$  and where  $f(\alpha) = \alpha^9$ .

The Gravitational finestructure, here named Omega, is further described in a five folded supersymmetry of the string hierarchies, the latter as indicated in pentagonal or five folded supersymmetries.

This pentagonal supersymmetry can be expressed in several ways, say in a one-to-one mapping of the Alpha finestructure constant as invariant  $X$  from the Euler Identity:  $X+Y = XY = -1 = i^2 = \exp(i\pi)$ .

A Unification Polynomial:  $(1-X)(X)(1+X)(2+X) = 1$  or  $X^4 + 2X^3 - X^2 - 2X + 1 = 0$  is used to find the coupling ratios:  $f(S) | f(E) | f(W) | f(G) = \# | \#^3 | \#^{18} | \#^{54}$  from the proportionality  $\# | \#^3 | \{[(\#^3)^2]\}^3 | \{[(\#^3)^2]\}^3 = \text{Cube root}(\text{Alpha}) : \text{Alpha} : \text{Cuberoot}(\text{Omega}) : \text{Omega}$ .

The Unification polynomial then sets the ratios in the inversion properties under modular duality:  $(1)[\text{Strong short}] | (X)[\text{Electromagnetic long}] | (X^2)[\text{Weak short}] | (X^3)[\text{Gravitational long}]$  as  $1 | X | X^2 | X^3 = (1-X) | (X) | (1+X) | (2+X)$ .

Unity 1 maps as  $(1-X)$  transforming as  $f(S)$  in the equality  $(1-X) = X^2$ ;  $X$  maps as invariant from  $f(E)$  in the equality  $(X) = (X)$ ;  $X^2$  maps as  $(1+X)$  transforming as  $f(W)$  in the equality  $(1+X) = 1/X$ ; and  $X^3$  maps as  $(2+X)$  transforming as  $f(G)$  in the equality  $(2+X) = 1/X^2 = 1/(1-X)$ .

The mathematical pentagonal supersymmetry from the above then indicates the physicalised T-duality of M-theory in the principle of mirror-symmetry and which manifests in the reflection properties of the heterotic string classes  $HO(32)$  and  $HE(64)$  as the 3<sup>rd</sup> and 5<sup>th</sup> string classes, respectively.

Defining  $f(S) = \# = 1/f(G)$  and  $f(E) = \#^2 \cdot f(S)$  then describes a symmetry breaking between the 'strong S'  $f(S)$  interaction and the 'electromagnetic E'  $f(E)$  interaction under the unification couplings.

This couples under modular duality to  $f(S) \cdot f(G) = 1 = \#^{55}$  in a factor  $\#^{-53} = f(S)/f(G) = \{f(S)\}^2$  of the 'broken' symmetry between long-range- and short-range interactions.



SEWG = 1 = Strong-Electromagnetic-Weak-Gravitational as the unified supersymmetric identity then decouples in the manifestation of string-classes in the de Broglie 'matter wave' epoch termed inflation and preceding the Big Bang, the latter manifesting at Weyl-Time as a string-transformed Planck-Time as the heterotic HE(64) class.

As SEWG indicates the Planck-String (class I, which is both open ended and closed), the first transformation becomes the suppression of the nuclear interactions sEwG and describing the self-dual monopole (string class IIB, which is loop-closed in Dirichlet brane attachment across dimensions say Kaluza-Klein  $R^5$  to Minkowski  $R^4$  or Membrane-Space  $R^{11}$  to String Space  $R^{10}$ ).

The monopole class so 'unifies' E with G via the gravitational finestructure assuming not a Weylian fermionic nucleon, but the bosonic monopole from the  $k_e G_o = 1$  initial-boundary condition  $G_o m_{\text{Monopole}}^2 = k_e e^2$  for  $m_{\text{Monopole}} = e/G_o = k_e e = [30ec]_{\text{mod}} = m_{\text{planck}} \cdot \sqrt{\alpha}$ .

The Planck-Monopole coupling so becomes  $m_{\text{planck}}/m_{\text{monopole}} = m_{\text{planck}}/30[ec]_{\text{mod}} = 1/\sqrt{\alpha}$  with  $f(S) = f(E)/\#^2$  modulating  $f(G) = \#^2/f(E) = 1/\# \leftrightarrow f(G)\{f(S)/f(G)\} = \#$  in the symmetry breaking  $f(S)/f(G) = 1/\#^{53}$  between short (nuclear asymptotic) and long (inverse square).

The short-range coupling becomes  $f(S)/f(W) = \#/\#^{18} = 1/\#^{17} = \text{Cube root}(\text{Alpha})/\text{Alpha}^6$  and the long-range coupling is  $\text{Alpha}/\text{Omega} = 1/\text{Alpha}^{17} = \#^3/\#^{54} = 1/\#^{51} = 1/(\#^{17})^3$ .

The strong nuclear interaction coupling parameter so becomes about 0.2 as the cube root of alpha and as measured in the standard model of particle physics in the form of an energy dependent 'running coupling constant' and which takes a value of  $\alpha_z = 0.1184$  at the energy level of the  $Z_o$  weakon at about 92 GeV.

The monopole quasimass  $[ec]_{\text{mod}}$  describes a monopolar source current  $ef$  from the unification identity  $1/e * f_{ps} = h = E^*/f_{ps}$  as a fine structure for Planck's constant  $h$ , manifesting for a displacement  $\lambda = c/f$ . This is the GUT unification energy of the Dirac Monopole at precisely  $[c^3]$  eV or  $2.7 \times 10^{16}$  GeV and the upper limit for the Cosmic Ray spectra then as  $[30c^3] = 8.1 \times 10^{17}$  GeV\*as the physical manifestation for the string classes: I, IIB, HO(32), IIA and HE(64) in order of modular duality transmutation.

The transformation of the Monopole string into the XL-Boson string decouples Gravity from sEwG in sEw.G in the heterotic superstring class HO(32). As this heterotic class is modular dual to the other heterotic class, HE(64), it is here, that the proto nucleon mass is defined in the modular duality of the heterosis in:  $\text{Omega} = \text{Alpha}^{18} = 2\pi G_o m_c^2 / hc = m_c / m_{\text{planck}}^2$ .

The HO(32) string bifurcates into a quarkian X-part and a leptonic L-part, so rendering the bosonic scalar spin as fermionic half spin in the continuation of the 'breaking' of the supersymmetry of the Planckian unification. Its heterosis with the Weyl-string then decouples the strong interaction at Weyl-Time for a Weyl-Mass  $m_w$ , meaning at the time-instanton of the end of inflation or the Big Bang in sEw.G becoming s.Ew.G.

The X-Boson then transforms into a fermionic protonucleon triquark-component (of energy  $\sim 10^{-27}$  kg or 560 MeV), and the L-Boson transforms into the proto-muon of energy about 111 MeV. The last 'electroweak' decoupling then occurs at the Fermi-Expectation Energy about 1/365 seconds after the Big Bang at a temperature of about  $3.4 \times 10^{15}$  K and at a 'Higgs Boson' energy of about 298 GeV.

A Bosonic decoupling preceded the electroweak decoupling about 2 nanoseconds into the cosmogenesis at the Weyl-temperature of so  $T_{\text{weyl}} = T_{\text{max}} = E_{\text{weyl}}/k_B = E_{\text{ps}}/k_B = 1.4 \times 10^{20}$  K as the maximum Black Hole temperature maximized in the Hawking MT modulus and the Hawking-Gibbons formulation:

$$M_{\text{critical}} T_{\text{min}} = \frac{1}{2} m_{\text{planck}} T_{\text{planck}} = (hc/2\pi G_0)(c^2/2k_B) = hc^3/4\pi k_B G_0 \text{ for } T_{\text{min}} = 1.4 \times 10^{-29} \text{ K in Boltzmann constant } k_B.$$

The Hawking Radiation formula results in the scaling of the Hawking MT modulus by the factor of the 'Unified Field' spanning a displacement scale of  $8\pi$  radians or  $1440^\circ$  in the displacement of  $4\lambda_{\text{ps}}$ .

The XL-Boson mass is given in the quark-component:  $m_x = \#^3 m_W/[ec]$   
 $= \text{Alpha} \cdot m_W/m_{\text{planck}} = \#^3 \{m_W/m_{\text{planck}}\} \sim 1.9 \times 10^{15} \text{ GeV}$ ; and the lepton-component:  
 $m_L = \text{Omega} \cdot [ec]/\#^2 = \#^{52} [ec/m_W] \sim 111 \text{ MeV}$ .

It is this lepton component which necessitates the existence of the muon (and the tauon and their neutrino partners as constituents of the weak interaction gauge bosons) as a 'heavy electron', as the quantum geometry defines the muon mass in a decoupling of the L1 energy level given in a diquark hierarchy and based on a quantum geometry of the quantum relativity.

The definition of quantum consciousness is so obtained in the definition of magnetopolar charge  $e^* = 1/E_{\text{weyl}} = 1/E_{\text{ps}}$  in the units of the Star Coulomb being the measurement of inverse energy as the inversion of the unit for energy in the Joule as  $[J = \text{kgm}^2/\text{s}^2]^* = [1/C^*]$ .

For the parameters of the electron of mass  $m_e = k_e e^2/R_e c^2 = h\alpha/2\pi c R_e$  and classical displacement  $R_e = k_e e^2/m_e c^2$  and the Compton constant  $m_e R_e = k_e e^2/c^2 = h\alpha/2\pi c = \alpha \cdot L_{\text{planck}} \cdot m_{\text{planck}} = L_{\text{ec}} \cdot m_{\text{ec}}$  for monopolar distribution of electron masses and as a consequence of the Planck length oscillation as a minimum spacetime configuration causative for the Quantum Big Bang. The subscript 'ec' denotes the Grand-Unification monopole mass as the second-string class where mass  $m = E/c^2 = hf/c^2 = h/lc = h/(ec/c^2) = hc/e = [\text{Action}] \cdot c/e = [e^2]c/e = [ec]_{\text{mod}}$  of about  $4.818 \times 10^{-11} \text{ kg}^*$  as the Dirac monopole of the GUT energy in electronvolt as  $[ec]_{\text{mod}} \cdot c^2 = [c^3] \text{ eV}^*$ .

The Compton constant defines the inverse proportionality between the 'size' of the electron from point like at the wormhole radius at  $10^{-22} \text{ m}^*$  to its maximized extent at  $R_e = 2.777 \dots \times 10^{-15} \text{ m}^*$  as a function of its mass in  $m_{\text{ec}} \cdot L_{\text{ec}} = h/2\pi c$ , relative to  $m_e R_e = h\alpha/2\pi c$ , with  $L_{\text{ec}} = R_e$  being the characteristic displacement scale for the weak nuclear interaction as the magnetic asymptotic confinement scale of the gluon-quark interactions, emerging in a kernel-inner mesonic ring-outer leptonic ring quantum geometry for the subatomic quantum mechanics of the elementary particles of the Standard Model.

For the minimized classical Weyl-size of the electron at a wavelength of  $10^{-22} \text{ m}^*$ , the Compton constant defines an effective mass of  $m_{\text{ec}} = h/2\pi c(R_{\text{weyl}}) = h/c(10^{-22}) = 2.22 \times 10^{-20} \text{ kg}^*$  for  $L_{\text{ec}} = R_{\text{weyl}}$ , which is the Weyl wormhole mass  $m_{\text{weyl}} = m_{\text{ps}} = E_{\text{ps}}/c^2$ .

The Heisenberg uncertainty principle relating energy with time and displacement with momentum in the expression  $\Delta E \cdot \Delta t = \Delta x \cdot \Delta p \geq h/4\pi$  applied to the quantum mechanical scale of de Broglie wave matter  $\lambda_{\text{dB}} = h/mv$  and the Compton mass-photon interaction  $\Delta x = r_{\text{compton}} = h/2\pi cm$  shows a natural limit for the measurement of position in  $\Delta p = \Delta mv \geq h/4\pi \Delta x = \frac{1}{2} mc$ .

When  $\Delta p$  exceeds  $mc$ , then  $\Delta E$  exceeds  $mc$  in the Energy-Momentum relation  $E^2=(pc)^2+(mc^2)^2$  and we can apply this natural limitation on measurement to the position of the electrostatic electron mass in a variable classical electron radius as  $r_{ec}=\alpha h/2\pi cm=\alpha r_{compton}=\{\mu_0 e^2 c/2h\} \cdot \{h/2\pi cm_{ec}\} = \mu_0 e^2/4\pi m_{ec}$  and rendering the Compton mass-photon interaction modified in the electromagnetic fine structure constant  $\alpha$  to relate the inverse proportionality between the electron's rest mass to its spacial extent in:

$$m_e R_e = \text{Compton constant} = \alpha h/2\pi c = l_{planck} \cdot \alpha \cdot m_{planck} = m_{ec} r_{ec}$$

The Compton constant ensures Lorentz invariance across all reference frames in cancelling the length contraction with the relativistic mass increase in the product of the proper length  $l_0$  and the proper rest mass  $m_0$  as  $l_0 \cdot m_0 = l_0 \gamma \cdot m_0 / \gamma$  in special relativity (SR) in the self-relative reference frame of the monopolar electron and with  $\gamma = 1/\sqrt{1-v^2/c^2}$ .

Physicalized Consciousness is a monopolar source current  $I_{monopolar}$ , acting on a spacetime volumar coupled to the time differential of frequency as defined by the spacetime awareness enclosed in the volumar. The source monopolar current is equivalent to the mass of the interaction.

For the resonance energy state, the spacetime awareness  $df/dt$  is  $\{df/dt\}_{max} = f_{ps}/f_{ss} = f_{ps}^2 = 9 \times 10^{60}$  frequency eigenstates, defining the volume of the Restmass-Photon RMP as the 'dark matter' particle of physicalized consciousness

$$V_{rmp} = e^* / \{df/dt\}_{max} = 2R_e c^2 / \{df/dt\}_{max} = 500/9 \times 10^{60} = 5.555... \times 10^{-59} [m^3]^* \text{ and calculates as } R_{rmp} = \sqrt[3]{\{5.555... \times 10^{-59}\} / 2\pi^2} = 1.933... \times 10^{-21} m^* \text{ for a toroidal hyper-surface volumar } (V^4 = \frac{1}{2}\pi^2 R^4 \text{ for } dV^4/dR = 2\pi^2 R^3 = (2\pi R) \cdot (\pi R^2)) \text{ for a 3-dimensional Horn Torus) and calculates as } R_{rmp} = \sqrt[3]{\{5.555... \times 10^{-59}\} / 4\pi/3} = 9.109... \times 10^{-21} m^*$$

$$\begin{aligned} \text{The resonance state with the source energy quantum}\{\text{proportionality constant}\} \cdot V_{weyl} \cdot \{df/dt\}_{weyl} \\ = E_{weyl} = hf_{weyl} = m_{weyl} c^2 = k_B T_{weyl}, = \{\text{mass/displacement}\} \cdot V_{weyl} \cdot \{df/dt\}_{weyl} = \{ec/\text{displacement}\} \cdot V_{weyl} \cdot \{df/dt\}_{weyl} \\ V_{weyl} \cdot \{df/dt\}_{weyl} = \{I_{monopole}\} \cdot V_{weyl} \cdot \{df/dt\}_{weyl} = \{\text{monopolar mass current} = E_{weyl} = hf_{weyl} = m_{weyl} c^2 = k_B T_{weyl} \end{aligned}$$

Logos Mathimatia or the universal intelligence then defines the parameter  $df/dt$  as the unit of spacetime awareness, which if multiplied by the wormhole volumar of the Weyl string  $V_{weyl}$  of the Quantum Big Bang will define the source energy quantum from first principles as  $\{\text{proportionality constant}\} \cdot V_{weyl} \cdot \{df/dt\}_{weyl} = E_{weyl} = hf_{weyl} = m_{weyl} c^2 = k_B T_{weyl}$ , in the mathematical formulations for the energy transformations in electromagnetic radiation (Planck) and mass (Einstein) and temperature as kinetic energy (Stefan-Boltzmann) respectively.

The proportionality constant in units' mass/displacement [kg/m] describes Maxwell's displacement current in the non-inertial reference of the Stoney units of the transformation of the Planck string into the Stoney monopole string.

Dirac's monopole becomes the singularity of the creation event in the Quantum Big Bang Singularity or QBBS as a universal mirror connecting nowhere in notime as a one-dimensional Dirac superstring dividing the timespace of abstract mathematical, algorithmic, and logical definition to a spacetime rediscovering the potential of the timespace in the flow of time and the experience of spacial separation.

This serves the universal purpose to manifest the potential energy configurations of physicalized consciousness in the activity and dynamical interactions of physical information carriers.

The increase of physicalized consciousness in the quantum acceleration potential  $df/dt$  in the cosmology enhances the self-awareness of the physicalized information processors in the potential transformation of restmass quanta defined in the low energy part of the supermembrane  $E_{ps}E_{ss}$ .

As the restmass quanta  $m_{ss}$  are always coupled to the Unified Field of Quantum Relativity (UFoQR) and the agency of the Restmass-Photon RMP as a dark matter agent for the UFoQR; the definition for physicalized consciousness as the angular radial independent quantum acceleration acting upon any volumar of space ensures the dynamic evolvement of volumar spacetime in the experience of the flow of time common to both the experienced spacetime and its generating timespace.

In timespace the absence of duration as a unit count is replaced in the ordering principle for events, independent on any duration count between the occurrence of the events.

The perception of spacetime becomes however a function of individuated physicalized consciousness in its scope of resonating with the source energy parameters in the form of the time differential for eigen-frequency specifying the 'spacial awareness' as an eigen- or self-state to harmonize or resonate with the timespace definitions made manifest in spacetime.

The inertial frame of self-reference defines the acceleration of a magnetic charge generating monopolar electromagnetic radiation (EMMR) as a form of the original Electromagnetic Monopolar Interaction EMMI light path of the creation event and where the parameter of a magnetic point charge as the mass of a magnetic monopole becomes the quantum for the RMP as the dark matter agent and as a fifth fundamental interaction in the UFoQR in mirror capacity to the electropolar charge of the electron.

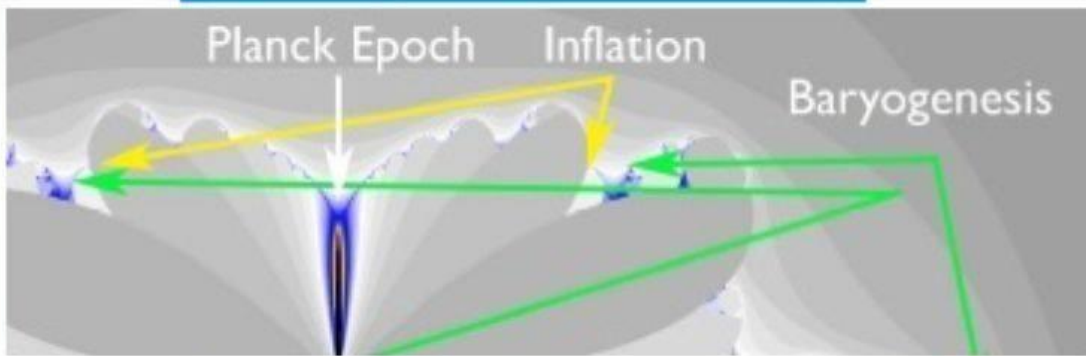

$$\begin{aligned}
 E^* &= E_{ps} = hf_{ps} = hc/\lambda_{ps} = m_{ps}c^2 \\
 &= (m_e/2e) \cdot \sqrt{[2\pi G_0/\alpha hc]} = \{m_e/m_{\text{Planck}}\} / \{2e\sqrt{\alpha}\} \\
 &= G_0 m_e / 2e^2 = 1/2R_e c^2 = 1/e^*
 \end{aligned}$$

*And God said*

$$\nabla \cdot \vec{E} = \frac{\rho_e}{\epsilon_0}$$

$$\nabla \cdot \vec{B} = \mu_0 \rho_m$$

$$\nabla \times \vec{E} = -\frac{\partial \vec{B}}{\partial t} - \mu_0 \vec{J}_m$$

$$\nabla \times \vec{B} = \mu_0 \vec{J} + \frac{1}{c^2} \frac{\partial \vec{E}}{\partial t}$$

*and there was light.*

*Then Maxwell said*

For Divergence:  $\iiint \nabla \cdot (\vec{E}, \vec{B}) dV = \text{Flux } \Phi_{e,m} = \iint (\vec{E}, \vec{B}) \cdot d\vec{A}$   
 For Curl:  $\iint \nabla \times (\vec{E}, \vec{B}) \cdot d\vec{A} = \text{Flux } \Phi_{e,m} = \oint (\vec{E}, \vec{B}) \cdot d\vec{l}$

$$\iint \vec{E} \cdot d\vec{A} = \frac{Q}{\epsilon_0} = \int_V \frac{\rho_e}{\epsilon_0} dV$$

$$\iint \vec{B} \cdot d\vec{A} = 0 = \int_V \mu_0 \rho_m dV$$

$$\oint \vec{B} \cdot d\vec{l} = \mu_0 i_C + \mu_0 \epsilon_0 \frac{d\Phi_E}{dt}$$

$$\oint \vec{E} \cdot d\vec{l} = -\frac{d\Phi_B}{dt}$$

*Lorentz Force:  $\vec{F} = q_e \{ \vec{E} + \vec{v} \times \vec{B} \} + q_m \{ \vec{B} - \vec{v} \times \vec{E} / c^2 \}$*

Time began from nowhere in notime at the now time of the source energy becoming conscious of itself and the creation of somewhere from sometime became the logical consequence of the birthing of time as a spacetime parameter and function to enable the original consciousness energy experience itself as its own parts or 'children of descendancy' in the sharing of the universal or cosmic self-consciousness.

The function and primary focus of spacetime then is to manifest a mirror symmetry between the ancestral original creator source consciousness and the descendent created source consciousness known as spacetime awareness.

The source energy is known and labeled in many ways and including the names of 'God' and the great 'I AM' and gods, as 'All That Is' and as deifications of mythos and of history in the libraries and records of the history of the worlds.

{MATHIMATIA=95=IAMTHATIAM=EXCALIBUR=NEPTUNRE=SCORPIO=59=DRAGON in code Exo.3.14 with DRAGONMADE=82=ARMAGEDDON in the WORDSOFAPSALM=162=SWORDOFPLASMA}.

The stories of creation and of the gods so share particular similarities and differ in other aspects as a function of culture and custom and regionality, relative to the scribes and record keepers indigenous to an area, where the records are being composed and collected.

The creative source is known in the Mathimatia of the Universal Logos-Sophia as the universal intelligence or source energy manifesting itself from a timeless and space-independent realm labeled as timespace in spacetimes interwoven in the physical parameters of spacial extent and a timed duration between events; the primary and spacetime-aware.

To relate the nospace and the notime with space and time a modular inversion and mirror duality becomes integrated in the creation of a protoversal seed with the potential to reflect and mirror its creation modular duality in the inversion properties of quantization of the micro-self-states and the macro-self-states of existence in the form of a supermembrane consisting of two interwoven, albeit reciprocated parts.

The high energy and micro-quantum part are known as Abba as the name of the creator-creation sourcesink, and the macro-quantum part is known as Baab as the name of the creation-creator sinksources in a generalised White-Hole-Black-Hole or Yang-Yin or DNA-RNA or chicken-egg or male-female or phallus-yoni cosmology.







The Null-Zero Point Singularity Dimension at the Center of the Earth hosts the Memory of the Universe, defined in Time and Space. The Volume of the Inner Space of the planetary body of Gaia is separated from its Volume of the Outer Space by its surface or membrane and as a 3-dimensional geometrical topological Inner Mirror of 2D-Line Space (or Area) with 1D-Time.

This dimensional divide is imaged as the Boundary of the Universe within a multidimensional Omniverse and where the Outer Mirror separates the Inner Space of 10 string dimensions from its Outer Space in 12 brane dimensions. The 12th brane dimension recircularizes the lower dimensional nesting of the omniversal ovum and therefore images and recreates the Null-Zero Point Dimension at the centre of Gaia as a Time-Point Singularity of Null Space.

The 10-dimensional Omniverse defined in a space of 10D, therefore utilizes a 11th Time Dimension as a topological mirror-membrane-surface dimension of 'Pointed Time' to image or 'collect' or absorb the spacetime structure inside of itself in a form of space-defined consciousness quanta and as the 'Cosmic Memory' of the timebased history of the Omniversal Evolution. As the 10th string dimensions of in topological Membrane Space is equivalent to the 12th brane dimension in the closure of the plenum continuity; the Singularity at the Core of Gaia as a planetary metaphysical hypergeometric Center WITHIN a timebased cosmology becomes equivalent to the Singularity upon the entire surface or boundary of the Omniverse as the WITHOUT.

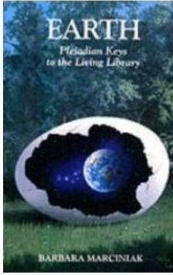
The Time-Point at the Center of the Earth defines the Locus for the generation of the 1st Dimension from the Null Dimension in tracing a Line to manifest the 1-2-3 Volumar of Geometry Space embedded or nested within 10D Omnispac as PosSpace (positive space).

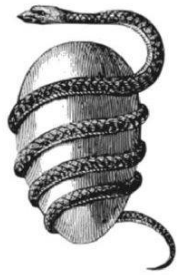
The Time-Point at the Membrane Mirror defines the Locus for the generation of the 12th Dimension from the 11th Dimension in a Time-Point tracing a Super Space Line to manifest a 12-13-14 Supervolumar of supergeometry space. As however, the Time-Point of the Null Dimension is defined in its relative 'negative space' rendering 10D-Omnispac equivalent to 12D-Superspace; this tracing no longer requires dimensional extension into Superspace or NegSpace (negative space). The tracing of Omnispac therefore closes the multidimensional dynamic in the image of the Gaian Core of the Cosmos manifesting the initializing dimension generation in Line Space 0-1-2-3-(4=0=Time) in the generator 10-11-12-(13=4=Time) and rendering the Line Space Time 1-2-3-4 equivalent to the Omni Space Time 10-11-12-13.

<p><b>Focus Location Library</b></p> 	<p><b>Director</b> ABBA + JC</p>	<p><b>Thematic Scenario &amp; Context Communication</b></p> 	<p><b>Producer</b> BAAB + CJ</p> 	<p><b>Weaver Author Scribe</b></p> 
<p><b>Executive</b></p>	<p><b>Playwright = CJJC</b></p>	<p><b>Jurisdiction</b></p>	<p><b>Playwright = JCCJ</b></p>	<p><b>Legislative</b></p>

00D=Null/Zero-Point Dimension  
 01D=Line/String Dimension  
 02D=Area/Membrane Dimension  
 03D=Volume/Superbrane Dimension  
 04D=1x3DL+1T=4DLT=Space Time  
 05D=1x3DL+2T=4DLT+M\*  
 06D=2x3DL+0T=4DLT+2DR  
 07D=2x3DL+1T=4DLT+3DR  
 08D=2x3DL+2T=4DLT+3DR+M\*\*  
 09D=3x3DL+0T=4DLT+3DR+2DQ  
 10D=3x3DL+1T=4DLT+3DR+3DQ  
 11D=3x3DL+2T=4DLT+3DR+3DQ+M\*\*\*  
 12D=4x3DL+0T=4DLT+3DR+3DQ+2DS  
 13D=4x3DL+1T=4DLT+3DR+3DQ+3DS



## XVI: Quantum Consciousness in the Penrose-Hameroff Model

### Cosmological relevance of microtubules to the size of the electron as conformal wormhole quantization in quantum geometry

[View: https://www.youtube.com/watch?v=XxOSsffdMBw](https://www.youtube.com/watch?v=XxOSsffdMBw)

[View: https://www.youtube.com/watch?v=jXBfXNW6Bxo](https://www.youtube.com/watch?v=jXBfXNW6Bxo)

The number of micro tubules in the Hameroff-Penrose model for physicalized consciousness can be related to the actual scale of the classical electron radius and the cosmological spacetime matrix.

Using this conformal mapping from the Quantum Big Bang 'singularity' from the electric charge in brane bulk space as a magnetic charge onto the classical spacetime of Minkowski and from the Planck parameters onto the atomic-nuclear diameters in  $2R_e c^2 = e^*$  from the Planck length conformally maps the Planck scale onto the classical electron scale.

A conformal scale of 2.5 fm, which is close to the classical electron radius of about 2.8 fermi and as defined in the alpha electromagnetic fine structure and the related mass-charge definition for the eigen energy of the electron in  $m_e c^2 = ke^2/R_e$ .

Applying  $E_G = \hbar/t$  to microtubule quantum computing terminated by OR

Gravitational self-energy  $E_G$  of a superpositioned tubulin is given by  $E_G = Gm^2/a_c$  where  $a_c$  is the superposition separation distance, a carbon nucleus sphere radius equal to 2.5 fermi distances (2.5 femtometers,  $2.5 \times 10^{-15}$  meter)

For  $t = 50$  msec (gamma synchrony),  $E_G$  of  $10^{10}$  superpositioned tubulins is required

Hameroff and Penrose, 1996



Also in a model of quantum relativity (QR), there is a quantization of exactly  $10^{10}$  wormhole 'singularity-bounce' radii defining the radian-trigonometric Pi ratio as  $R_{\text{wormhole}}/R_{\text{electron}} = 360/2\pi \cdot 10^{10}$  or  $10^{10} = \{360/2\pi\}\{R_e/R_{\text{wormhole}}\}$  as a characteristic number of microtubules in a conformal mapping from the classical electron space onto the 'consciousness' micro-space of the neuron-cell intermediate between the Hubble scale of  $10^{26}$  m and the Planck scale of  $10^{-35}$  m as geometric mean of  $10^{-4}$  to  $10^{-5}$  meters.

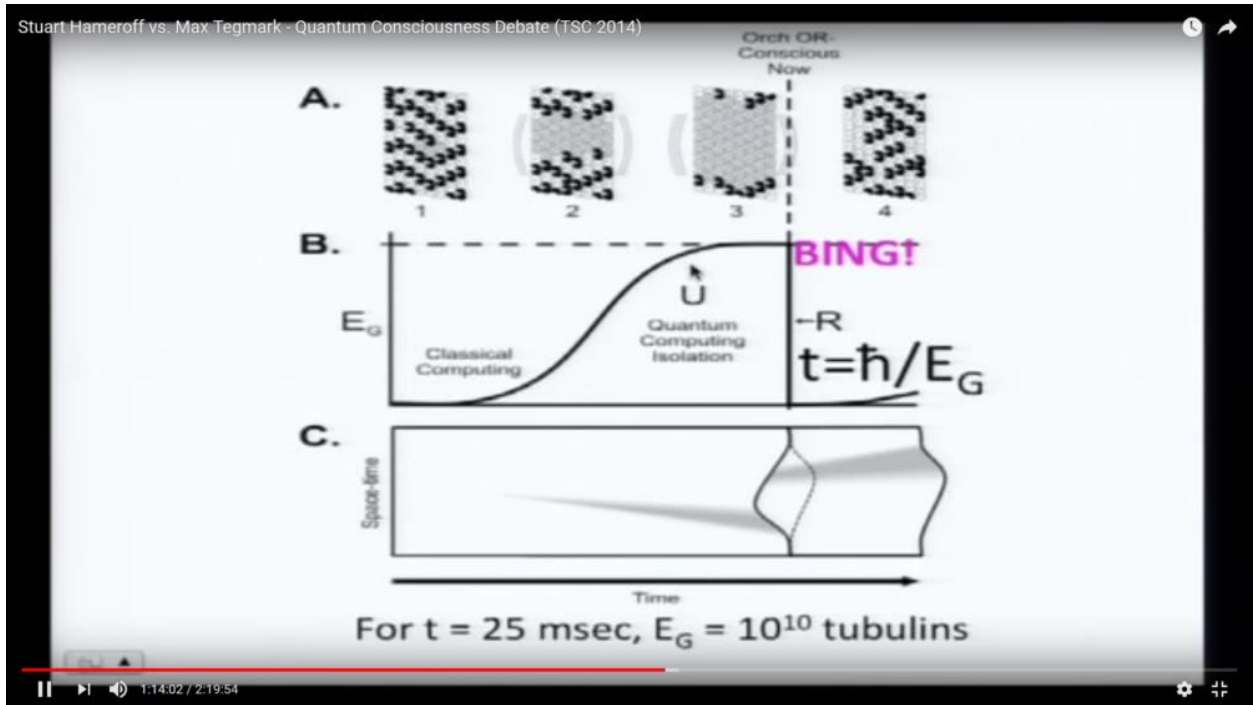

The geometry of the architecture of the microtubules and the nature of their construction utilizing the pentagonal quasi-crystalline pattern in its application, so maximizes the compression of information in the Fibonacci geometrical pattern-sequencing. This then results in the conformal mapping of this geometry as a quantum geometry and defines physical consciousness as a conformal mapping of the quantum of spacetime in the form of Weylian 'Quantum Big Bang' wormholes of the cosmogenesis.

The pre-Big Bang 'bounce' of many models in cosmology can be found in a direct link to the Planck-Stoney scale of the 'Grand-Unification-Theories'. In particular it can be shown, that the Square root of Alpha, the electromagnetic fine structure constant  $\alpha$ , multiplied by the Planck-length results in a Stoney-transformation factor  $L_P\sqrt{\alpha} = [e/c^2]_{\text{mod}}$  in a unitary coupling between the quantum gravitational and electromagnetic fine structures  $\{G_0k=1$  and representing a conformal mapping of the Planck length onto the scale of the 'classical electron' in superposing the lower dimensional inertia coupled electric charge quantum 'e' onto a higher dimensional quantum gravitational-D-brane magnetopole coupled magnetic charge quantum 'e\*' =  $2R_e \cdot c^2 = 1/hf_{ps} = 1/E_{\text{Weyl wormhole}}$  by the application of the mirror/T duality of the super membrane  $E_{ps}E_{ss}$  of heterotic string class  $HE(8 \times 8)$ .

This boundary condition on a universal Black Hole evolution can be based on the definition of physical consciousness and the magneto charge as the Eps-gauge photon, acting as prime agency in a Unified-Field-Of-Quantum Relativity or UFOQR.

As magneto charge  $e^* = 1/hf_{ps}$  in the units of the Star Coulomb could be written as  $[C^*] = [m^3/s^2]^*$ ; the Gravitational parameter GM in the same units  $[Nm^2/kg^2] \cdot [kg] = [m^3/s^2]$  could be used for the purpose to relate the volume occupied by a Black Hole to the ubiquitous nature of physical consciousness as permeating spacetime itself.

This is mathematically expressed in the Fibonacci sequence and the Euler Identity.

The FRB or Functional-Riemann-Bound in Quantum Relativity is basic to the pentagonal string/brane symmetries and is defined in the renormalization of a wavefunction  $B(n) = (2e/hA) \cdot \exp(-\alpha \cdot T(n))$ , exactly about the roots X and Y, which are specified in the unifying condition of the Euler Identity:

$$XY = X+Y = i^2 = -1 = \cos(\pi) + i\sin(\pi) = e^{i\pi}$$

$X = \frac{1}{2}(\sqrt{5}-1) = 0.618033\dots$  and  $Y = -(X+1) = -\frac{1}{2}(\sqrt{5}+1) = -1.618033\dots$   
 $-X(X-1) = 0.236067\dots$  in analogue to  $X(X+1) = 1 = T(n)$  and  $XY = X+Y = -1 = i^2$   
as the complex origin.

**The Cosmic Wavefunction in the UFOQR is the following Differential Equation:**

$$dB/dT + \alpha B(n) = 0;$$

$\alpha$  being Alpha, the Electromagnetic Fine structure as the probability of light-matter interaction ( $\sim 1/137$ ).

This has a solution:

$$B(n) = B_0 \cdot \exp[-\alpha \cdot T(n)]; B_0 = 2e/hA \text{ from QR boundary conditions defining:}$$

$T(n) = n(n+1)$  as the Feynman Path-Summation of particular histories under the pentagonal supersymmetry given in the (Euler) identity:

$$XY = X+Y = -1 = i^2 = \exp[i\pi] \text{ and for the limiting condition: } \lim [n \rightarrow X] \{T(n)\} = 1$$

This allows the Normalization of the  $[\Psi]^2$  wave function to sum to unity in  $B(n) = (2e/hA) \cdot \exp[-\alpha \cdot n(n+1)]$  with Functional Riemann Bound FRB=-1/2, centered on the interval  $[Y, \dots -1, \dots -X, \dots -1/2, \dots (X-1), \dots 0, \dots X]$ .

Interval  $[Y, -1]$  sets F-Space; interval  $[-1, 0]$  sets M-Space with uncertainty interval  $[-X, (X-1)]$  and interval  $[0, n]$  sets the C-Space, encompassing Omni-Space.

$n < 0$  is imaginary as real reflection of real  $n > 0$  of the C-Space, metrically defined at the coordinate  $n=0$  mapping  $n=n_{ps}$ , which is the Instanton  $t_{ps}=f_{ss}=1/f_{ps}$ .

Cycle time  $n$  is defined in GR as dimensionless Tau( $\tau$ )-Time in curvature radius  $R_C=c \cdot dt/d\tau$  for the pathlength of  $x=ct$  and becomes  $dn/dt = H_0$ ,  $n = H_0 t$  in QR, with  $H_0$  the nodal Hubble Constant defined in  $c=H_0 R_{max}=\lambda_{ps} \cdot f_{ps}$ .

The Feynman Path so sums both negative and positive integers as:  
 $-n \dots -3 \dots -2 \dots -1 \dots 0 \dots 1 \dots 2 \dots 3 \dots n = T(n)$  in absolute value to double the infinities as the entropy reversal of light path  $x=ct=(-c)(-t)$  in the Möbius Property of the 4 worlds as outlined in the 13 dimensions of the time connectors.

Cantor Cardinality Aleph-Null is thus Unitized in Aleph-All, counting infinities as if they were integers of the Feynman Path.

This allows the Feynman interpretation of Quantum Mechanics as alternative to the formulations of Schrödinger (fermionic 1/2 spin) and Klein-Gordon (bosonic integral spin) as time independent and time dependent (free particle form inconsistent with SR in Schrödinger in 1st order  $t$  & 2nd order  $x$ ), formulations respectively.

The units of  $B(n)$  are  $1/J$ , that is Inverse Energy, with  $A^2$  an algorithmic constant defining Current-Squared and  $2e/h$  the Josephson Constant in Amperes/Joules.

$B(n)$  as the universal cosmic wavefunction describes the universe as a potentially infinite collection of 'frozen' wormhole eigenstates at  $n=0$ .

The time Instanton 'unfreezes' one such eigenstate and activates the protoverse as described in an arbitrary local time calibration, say November 4<sup>th</sup>, 1996; Canberra, Australia, local time, as an example to 'measure universal time, say in cosmic seconds  $s^*$ , backwards in time.

This then allows the 'Mappings' of the C-Space 'real time  $n>0$ ' from the F-Space of the 'imaginary time  $n<-1$ ' under utility of the M-Space interval as 'mirror-space'.



with  $T^2(n) = 1 = X(X+1) = -i^2 = -XY$  in the Feynman-Path-Integral as alternative quantum mechanical formulation for the equations of Schrödinger, Dirac and Klein-Gordon by:  $T(n)=n(n+1) = |-n| + \dots + |-3| + |-2| + |-1| + 0 + 1 + 2 + 3 + \dots + n$

$$B(n) = 2e/hA \cdot \exp[-\text{Alpha} \cdot T(n)]$$

Aleph-Null:  $\lim_{n \rightarrow \infty} (T(n)) = \infty$

Aleph-All:  $\lim_{n \rightarrow X} (T(n)) = 1$

$$|X+Y| = |XY| = -i^2 = 1$$

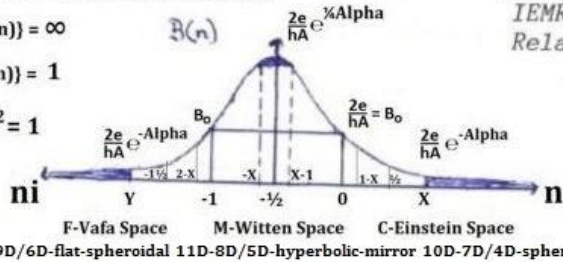

(Universal Cosmic Wavefunction or IEMR=Inverse-Energy-Magnetocharge-Relation for Superstring HE(8x8))

The universe is 'frozen' in M-Space at the X-coordinate for which  $T(n)=1$  and imaged in the Y-coordinate as imaginary time  $n_i$  as function  $B(n)$

$T(n)=n(n+1)$  defines the summation of particle histories (Feynman) and  $B(n)$  establishes the  $v/c$  ratio of Special Relativity as a Binomial Distribution about the roots of the  $XY=i^2$  boundary condition in a complex Riemann Analysis of the Zeta Function about a 'Functional Riemann Bound'  $FRB=-\frac{1}{2}$ .

A new physical quantity in 'awareness' is defined as the time differential of frequency and allows the concept of 'consciousness' to be born from the defining qualities of magneto charges. Electro magneto-monopolar 'Life' derives as consequence of self-inductions of quantum geometric entities, specified from supermembranes, macro-crystallized in electropolar self-capacitances and magnetopolar self-inductances, subsequently becoming subject to mutual cross-inductances.

The purpose of the superbranal self-replication on ever increasing scales, and until modular duality is reached in minmax boundary conditions; is to establish the multiversal nesting of the smallest within the largest - a process which constituted the beginnings of it all in the 'naked singularity' becoming defined as the Genesis BOSON in the Mathimatia of the Logos of Abba as the 'Modus Operandi' of Creation.

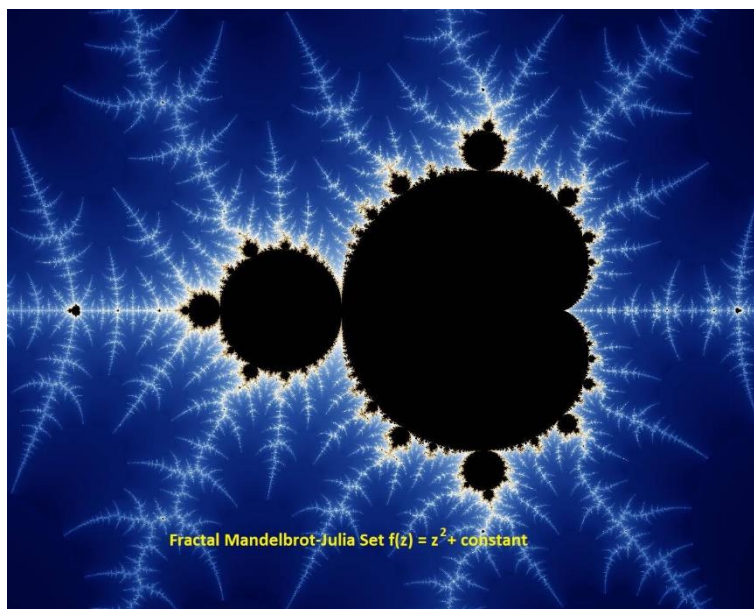

## *In the DNA*

The DNA molecule, the program for all life, is based on the Golden section. It measures 34 angstroms long by 21 angstroms wide for each full cycle of its double helix spiral. 34 and 21, of course, are numbers in the Fibonacci series and their ratio, 1.6190476 closely approximates Phi, 1.6180339. It is interesting to note as the technology improves and we get more accurate dimensions the ratio keeps getting closer to phi. It now appears that the ratio of the width to the vertical offset may also converge to the same ratio.

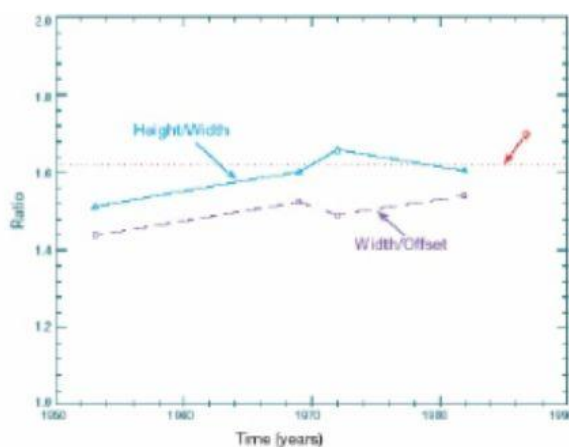

Figure 1

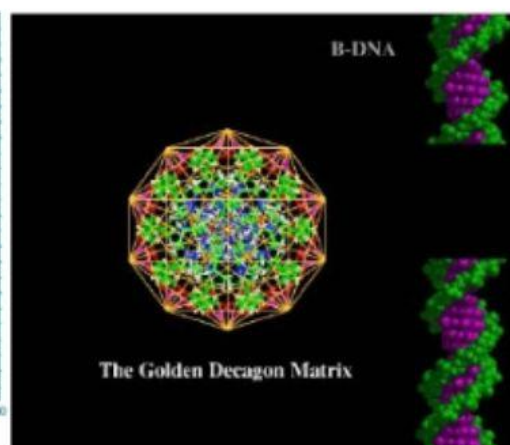

Figure 2

Figure 2 shows how a cross-section of the DNA perfectly fits into a decagon formed of golden elements.

The ratio becomes apparent in the frequency of bases in the DNA. Selvam (2002) using statistical tools has shown that the frequency of A,T,C,G bases in the Drosophila genome. His paper reads:

*“The observed fractal frequency distributions of the Drosophila DNA base sequences exhibit quasicrystalline structure with long-range spatial correlations or self-organized criticality... The dominant peak periodicities are functions of the golden mean.”*

This way non-reductionist studies are opening new avenues for science to explore.

### *In the Cell structure*

The ratio appears in certain very important structures of the cell. The hexagonal pattern of microtubules exhibits the Fibonacci feature and it is found that this pattern is made up of 5 right-handed and 8 left-handed helical arrangements.

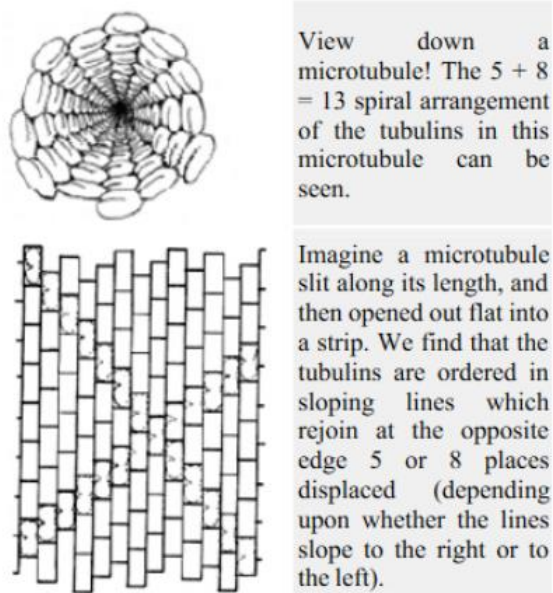

Figure 3

It is curious, also, that the double microtubules that frequently occur seem normally to have a total of 21 columns of tubulin dimers forming the outside boundary of the composite tube - the next Fibonacci number. Koruga (1974) argues for a special efficiency in the case of Fibonacci-number-related structure of microtubules that may provide advantage in its function as a "information processor". There must indeed be some good reason for this kind of organization in microtubules, since although there is some variation in the numbers that apply to eukaryotic cells generally, 13 columns seems to be almost universal amongst mammalian microtubules.

<https://www.scribd.com/.../105508014/Microtubules-Fibonacci>

## **What is Consciousness?**

### Answer:

The dynamic occupancy of spacetime by physicalised quantum conglomerations originating and emerging from an energy source defining nospacetime and notime in space and time.

Space is consciousness related via an advanced quantum mechanics. Therefore, you can figure out what the metaphysics or spirit concept really relates and points to. It is not *deus ex machina* but *machina ex deo*.

### Calculation:

7.4 Billion people weigh about 518 Billion kilograms for an average weight of 70 kg.

As one proton has a mass of about  $1.7 \times 10^{-27}$  kg; the total mass of humanity in weight are so  $3 \times 10^{38}$  protons.

One proton has a volume of so  $4 \times (1.4 \times 10^{-15})^3 = 10^{-44}$  cubic meters and for all the protons of humanity the volume adds to about  $3 \times 10^{-6}$  cubic meters or 3 cubic centimeters which is a cubic size for a cube about 14.4 millimeters long.

Question:

So, what is all that empty space doing...is their direct interaction between nucleons and virtual particles relating to the nature of "spin," or how the universe actually sustains itself from moment to moment?

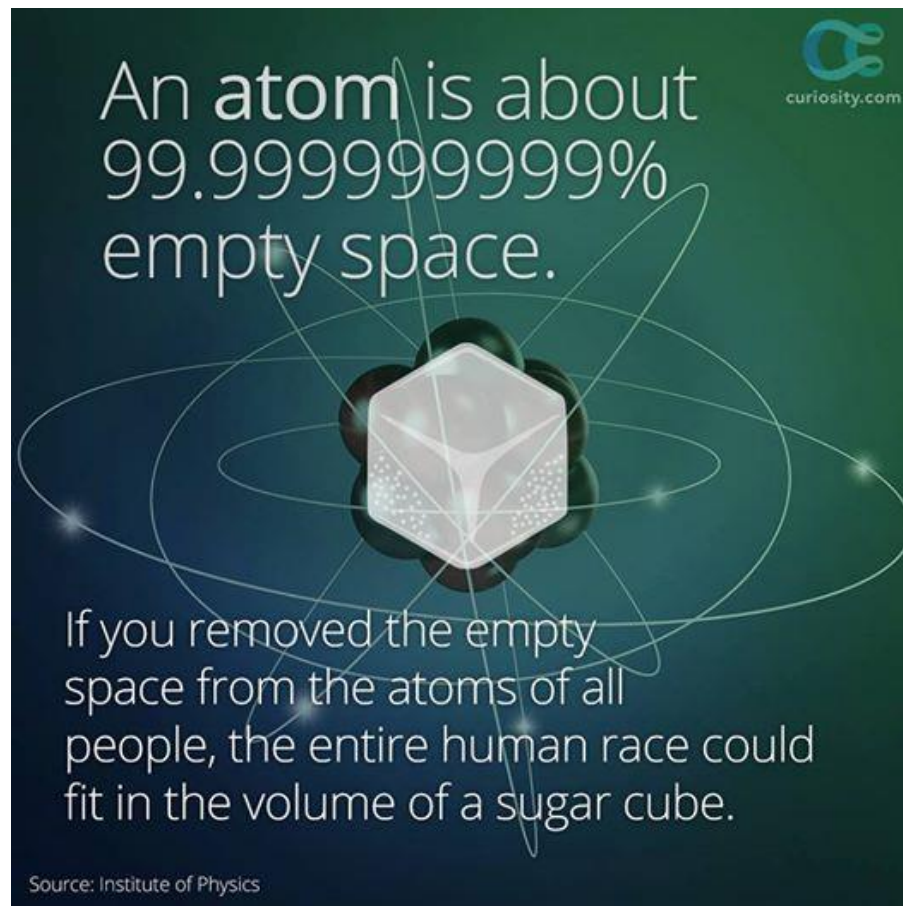

Answer:

This is an appropriate question, which leads directly into the deepest nature of what energy is and it relates on a most fundamental way to the reality of universal consciousness.

Firstly, the 'empty space' of an atom manifest as a form of 'force field' in that the interaction 'Goldstone' bosons mediate a 'force', which then manifests as the appearance of solid-state physics.

So, tapping a table actually taps an energy field etc. The problems with this mainstream physical interpretation and model begin right here, because the 'Goldstones' (photons, weakons, gravitons, gluons, higgs) are said to be 'virtual' that is not having a real physical existence.

This is erroneous, just as the mainstream notion of consciousness and mind being nonphysical is also not supported by a higher dimensional cosmology and physics. As an example, consider Einstein's  $E=mc^2$  applied to the total mass content of the universe. For a mass of say  $10^{50}$  tons you will have an energy summation of so  $10^{70}$  Joules.

But if you now use the quantum energy, also well defined in Planck parameters, you calculate the quantum energy per space quantum, and you get far higher values for this energy.

Using the conventions (Planck Length= $2 \times 10^{-35}$  m, Planck Mass= $2 \times 10^{-8}$  kg, Planck Energy= $2 \times 10^9$  J, Holographic bounds etc.) and using the Event Hubble extent of the universe, you get something like (Number of space quanta) $\times$ (Planck Energy) =  $(10^{147}) \times 2 \times 10^9 \sim 2 \times 10^{156}$  Joules. Now the string physics tells you that the energy per string quantum is something like  $10^{64}$  Joules per cubic meter as a physical manifesto of this quantum energy; whilst the energy of all (atomic) matter in space is something like  $10^{-10}$  Joules per cubic meter. So, the 'discrepancy' between quantum energy and matter energy is in a factor of so 74 (and 87 in the quantum-Planck limit). This number then becomes associated with the 'Dark Energy' and the 'Dark Matter' to explain the discrepancy.

The 'empty space' of the atom so is in fact 'spanned' by the 'virtual' energy which is dark and has a dark matter component which is defined in physical consciousness parameters based on the quantum energy parameters and especially the physical size of the electron.

This naturally allows a refined approach to fundamental physics, such as the difference between the Hydrogen atom and the neutron and how radioactive beta/neutron decay allows the primordial universe to build the table of the chemical elements. This transformation then relates to the interaction probability between matter and light in electromagnetic parameters so showing the basic electron to be a 'point particle/string' of a minimum size; but also, a 'smeared out' or extended circular membrane characterised by the Fermi scale of the 'Goldstone Bosons'.

The spacial extent of the differences then defines physical consciousness as a modular dual or mirror property of the space quantum itself; namely whatever is measured as energy derived from the macro-physics becomes a reciprocated magneto-polar 'supercharge' in the form of the electronic diameter maximized multiplied by the time differential of frequency as inversed time. But this change of string/brane vibration over time is also an angular acceleration without radial extent and so you find the innermost nature of the quantum spin, which is radially independent.

Those physical definitions for consciousness then carry enormous implications of course. Namely space itself is conscious in a physical sense and any dynamic occupying space adds to a space inherent base consciousness independent of the dynamics and living entities moving about within it.

Collapsing a hydrogen atom that is forcing the electron to overcome its weakon force field of the beta decay results in a neutron star of 'degenerate electrons' and you then can observe the quantum physics in the astrophysics. So, your original question regarding the empty space resolves in the transformation of energy density in space.

Then you should adapt the quantum theory to the holographic universe and the multidimensional membrane physics to resolve the wave-particle duality and the quantum entanglement on both the micro-cosmic and the macro-cosmic scales to find the universal unification. The quantum entanglement can easily be seen to be the effect of the modular duality inferred at the beginning to resolve a number of apparent paradoxes, such as the Schrödinger Cat and the Chicken-Egg DNA/RNA etc. paradoxes.







“Granted that Reason is prior to matter, I can understand how men should come to know a lot about the universe they live in. If, on the other hand, I swallow the scientific cosmology and for “scientific cosmology” we might read “Darwinism” as world view then not only can I not fit in religion, but I cannot even fit in science...

Mathematical Challenges to Darwin's Theory of Evolution with Berlinski, Meyer, and Gelernter



“If minds are wholly dependent on brains, and brains on biochemistry, and biochemistry on the meaningless flux of the atoms, I cannot understand how the thought of those minds should have any more significance than the sound of the wind in the trees.”  
— C.S. Lewis

43:34 / 57:13



<https://youtu.be/noj4phMT9OE>

#### References:

Roger Penrose & Stuart Hameroff (4 July 1992). "[Consciousness in the Universe: Neuroscience, Quantum Space-Time Geometry and Orch OR Theory](#)". *Journal of Cosmology*. [Quantumconsciousness.org](#). Archived from [the original](#) on 16 June 2012. Retrieved 13 August 2012.

S. Hameroff; R. Penrose (2014). "Consciousness in the universe: A review of the 'Orch OR' theory". *Physics of Life Reviews*. **11** (1): 39–78. [Bibcode:2014PhLRv..11...39H](#). [doi:10.1016/j.plrev.2013.08.002](#). [PMID 24070914](#).

## **XVII: God Reborn - The Birth of God as a Superbrane A Story of Intelligent Design and the Creation of the Quantum Universe in the Uniphyscon of Quantum Entangled Omnispace**

**The question of creation as quantum fluctuation ex nihilo is answered as a creation ex UniPhysCon as the quantum entanglement of omnispace in the form of universal physicalized consciousness.**

### **Foreword:**

A claim to have some answers to pertinent and profound questions in regards to the perennial quest of the human race to understand itself in being and in mind can be no statement of whimsicality.

Such a proposition demands a thorough investigation of the issues at hand; not a one-sided or biased examination of selected data and information; but a rigorous scientific approach to evaluate all the evidence supplied in the history of the developments, both in the popular culture and its science and the philosophies supporting it.

It is of limited value to parade the scientific discipline as the rational and impartial paradigm for the future; if that same worldview proves itself incapable to elucidate or to explain the most basic of elementary questions asked or problems faced by the now globalized citizen, placing hisher hope and expectation into that same projected future. And the overwhelming problem facing humanity at the beginning of the 21st century is that of its own philosophy.

‘Where are we now as a race?’, ‘Where are we going?’ and ‘Where did we come from?’ are some common questions asked, but not answered by the expert authorities in organized politics, science, culture, and religion. Why do we seem incapable, despite having built a monumental edifice called the scientific way and methodology; and notwithstanding the progressing technology derived from that; why then can that same worldview not answer a simple question like:

***“If there is such a thing as God, as so many of us have been told, then where and what is it?”***

We find an evolved human genetic disposition to form allegiances and to carry and ascribe to certain beliefs, often founded or exposted upon by certain individuals or groups. Kings and knights, magicians, clerics, and sages of old have transformed into the experts and advisors of the new.

Consultancy has become the catchphrase, often stifling the natural curiosity to find answers for one’s own questions in a denial of one’s own creative impulses through an adventure of self-discovery. Today, we find allegiances to political ideologies, religious dogmas, or some other culturally based agenda. All those liaisons and associations have something in common; however, they all become coloured in the individuals which belong to them. Redemption from this filtered state of affairs is found in a paradigm which is based on the precept of disallowing personality to individualize the work to be done or to colour the information to be collected as one’s personal archive or one’s private library of creation, subject to one’s own individual fancies and desires.

Albert Einstein once remarked:

***“The greatest trouble in the world is the idea of a personal God!”***

And so, one might agree with the de-personification of Albert Einstein's 'God,' whom he rather affectionately called: "***The Old One***" and of whom he also said: "***God does not play dice with the world,***" referring to his rejection of the idea that life and nature's processes are intrinsically arbitrary in a universe defined by chance and random events.

He thought of 'God' as being the intelligence behind the natural laws of nature, as found in the sciences and the mathematics which he studied and he believed that nature had to be based in geometrical principles, rather than in probabilities defined in statistics and stochastic matrices.

And there were others before and after him; Plato and Aristotle, upon whose dialogues this treatise is based; Pythagoras, the Greek geometers and Niels Bohr, Max Planck and Werner Heisenberg, all contemporaries of Albert Einstein with Paul Dirac, Max Born and Wolfgang Pauli in their contributions to the birth of quantum mechanics.

The symmetries in nature, numbers and sequences and fundamental constants; all seem finetuned and set into relationships with one another to create the universe and all the cosmological entities within it.

And one should not forget another genius of contemporary science in Isaac Newton. But what the modern world has tried to forget and to sequester away under an umbrella of a perceived historical ignorance, was the immense interest Isaac Newton, the father of all of classical mechanics, had in the concepts of religion.

And what is the modern moral evaluation by his peers, judging a man whom they portray to the students of science as having had no equal in his time in regard to his scientific work, inventions and mathematical insights?

His power of pure intellect, like Einstein's, is often used to exemplify the necessity for logical thought and concentration in the pursuit of scientific and mathematical excellence by the students in those fields.

Is it embarrassing to tell the full story; that Isaac Newton spent months at a time trying to decipher scrolls, like the 'Book of Daniel' and the 'Book of Revelation' in the bible?

***"He must have been deluded in the religious fervor of his age!"*** they would have said.

But was he?

Could a mathematical prodigy like Isaac Newton have been so gullible? Isn't it more likely, that he sensed that there was something to it – and that it had to be scientific?! Isaac Newton's 'God' is the same as Albert Einstein's 'God' and yet it is completely impersonal. It must be, by the definition of the working ethic!

But is it?

Could it be possible, that once the 'God of Science' has become impersonal, that then this same 'God' is reborn in a 'God of Omniscience,' who allows, even demands a personification, because of its own definition?

And what if that had been the masterplan throughout the ages anyway? Can we then ever know and understand such a masterplan?

And what if all the clerical authorities around the globe are forced by their own followers to take notice?

What if modern science can prove to them that their 'Allah' and 'Jehovah' and Yahwey and 'Brahma' and 'Baha' and 'Krishna' and 'Ra' and 'Osiris' and 'Set' and 'The Big Goat behind the Old Oaken Tree in the Walpurgisnacht on April 30th' are all one and the same as the 'Order out of Chaos!' defined in a Universal Logos or Universal Intelligence manifesting the Primordial Universal Consciousness as a Source Energy and a circumstance and phenomenology which could be called the 'Word of God' as its physical manifestation ?

What if their scriptures and ancient scrolls became illumined in a new light of omniscience; should their powerbase not become depersonalized if they are shown to have followed a very limited interpretation of their 'sacred texts' indeed?

Where would they go in their grandstanding of and about 'God's Law' for the 'chosen people' and for the 'infidels'?

It would be the end of falsified religious dogma and the death of manipulative religion as such. Because omniscience is Omni-Science, the Science of 'The All' for 'The All' and the German word for the cosmos or the universe is "*Das ALL*" - Albert Einstein and Max Planck and Werner Heisenberg and Wolfgang Pauli and Max Born would have liked that in their contemplations upon the natural order of things.

Albert Einstein also said: "***Science without Religion is lame and Religion without Science is blind***" - and this book shall try to synergize the two worldviews in a redefinition of Heisenberg's Uncertainty Principle and its statistical nature within a geometrical interpretation of quantum mechanics.

And then would peace between the nations have a chance, because of the demise of the old religions and the already internationally accepted profundity of the scientific way and methodology. Like music, dance or mathematics, a new language would sweep the old world of hate and dispossession, the ways of disempowerment and disbelief under the carpet of the illumination of a new base of knowledge.

A new song would be sung and the nations and tribes and families at war with each other could embrace one another in a new way of looking at the world around themselves and their individuated places within it. And all the many things they had learned from their history through the ages of humankind; all their legends, myths and fables, their religions, and sciences; all would become integrated within themselves in a renewed understanding and the death of their ignorance regarding themselves.

But to succeed, the initiation of this omniscience is first required to affect its own birthing process. The mathematical principles of necessity and sufficiency must be satisfied, and the scientific global community must become informed about the new dispensation. The premises of the new model also necessitate their scientific validation through experiment and verification in the collective scientific data base.

This then is the disclaimer for this play of words.

To scientifically empower the new dispensation; a scientifically rigorous approach in its elementary application cannot be avoided. Science cannot 'prove' something, without clearly identifying its parameters and boundary conditions.

There is an abundance of literature, which explains the present status quo in specialized fields of particle physics, quantum theory, unification physics and cosmology in a populist genre of communication.

Many discoveries add to that edifice on a daily basis.

This treatise then does not retell the stories, which have already been told in many other ways and media. A list of references points to supportive accounts of some popular ones amongst them. This essay attempts to explain the fundamentals, the principles and preconditions for what brought about the universe's occurrence and the parameters which led to its definition in the natural laws.

And it is happenstance, that those precepts and prerequisites existing before space and time came into being, have a relevance for the birth of the religions of history or what one could term the 'spiritual impulse'. The bearing upon the personality is found to be a subset of a collective psyche; what one might perceive as the groupmind of a race or species; a somewhat very unique genus, which despite the relativity of the observer and the heliocentric reality – finds itself at the center of the universe, as itself – the race of mankind!

The ultimate aim of science to unify all aspects of existence so becomes a quest to enhance all energy and matter towards their most basic and elementary form of manifestation. Once such a fundamental oneness is found and classified by science; then the scientific worldview will become enabled to cross-fertilize all its inter disciplinary factions and the global culture will be ready to purge itself from all unscientific and irrationally derived paradigms and belief systems.

That will be the death of superstition and of pseudoscience; the unscientific way of thinking and its many flawed perceptions in regard to observed natural phenomena.

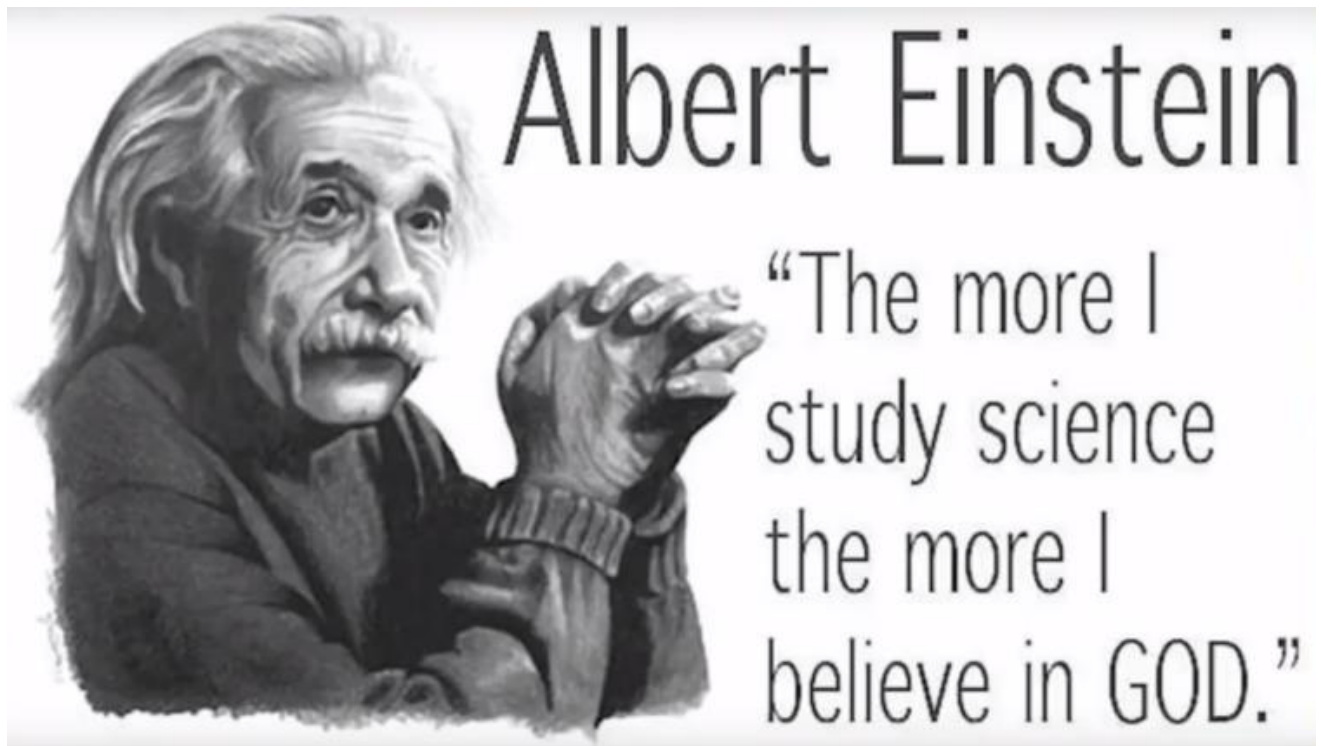

## Physical Consciousness coupled to the Biomind of Universal Life

The labels of 'mind' and 'self-awareness' and of 'consciousness' have for long awaited rigorous definition in the nomenclature of science. Whilst most researchers and philosophers accept the existence of those labels; what those naming represent in a physically measurable sense of physical parameters have remained largely unexplored.

These notions have remained as one of the major mysteries of science and have become subject to a number of speculations; from a purely materialistic interpretation of the 'mind' being a biochemical response to environmental stimuli, to the 'mind' being part of a 'spiritual soul' and subsequently constituting a transcendent aspect of biophysical life.

A related mystery is that of 'life' itself. How did the universe evolve 'life' from an accepted premise of a prior or older cosmology, which disallowed biological life as is observed today?

The thermodynamically expanding universe follows well tested physical parameters engaging the quantum nature of physical existence in the form of nucleosynthesis interactions such as nuclear fusion of atomic elements and an associated natural radioactivity inherent in nature and its laws of conservation of energy and momentum.

Those same processes occurred in the primordial universe and due to the smaller volume then occupied by the expanding universe; the descriptive cosmology describes a much hotter universe (as a Black Body Planckian Radiator) and a universe in which say the lifeforms observed on planet earth could not exist in their biochemical and molecular constitutions.

Recent advances in the demetricated forms of supermembrane theory (M-Theory for 11-dimensional supermembranes propagating 10-dimensional superstrings in a 12-dimensional self-dual mirror-spacetime of supervolumars (Vafa-F-Space encompassing Witten-M-Space) have allowed a rigorous definition for the above labels in the parameters of the physics of the superbranes.



## The Time fractal of the Genesis Code in Seven Days of Creation

The fractal of the Genesis code is the number 7 as a count of units of time.

A full day, as a circle of time counted as 360 degrees, can be divided into two halves of 180 degrees. The first half of the circle can be defined as lightness from a sunrise or dawn at 0 degrees to sunset at 180 degrees. The second half of the circle from 180 degrees to 360 degrees can then be defined as evening to morning of the full day. The period of time from sunrise to noon or midday to sunset of the 180 degrees is then halved into two 90-degree periods defining the upper half of the full circle as the Light of a Day and comprising 12 hours as 180 degrees.

The lower half of the circle of a full day then can be defined as the Darkness of a Night and comprising 12 hours as 180 degrees. The four 90-degree sectors of the circle can then be said to be four watches of 6 hours each and where a watch of 6 hours completes 90 degrees of the circle of 360 degrees.

One hour of the 24 hours of the complete circle therefore is defined as  $360/24=15$  degrees.

As one hour in a day represents 15 degrees of the full circle of 360 degrees, one day in 360 days defines a circle- or degree year as 360 days. Proportionally then, one hour in a day of 24 hours is the same as 15 days within a degree year of 360 days.

This defines a 'shortened time' as a count in hours from a 'standard time' as a count in days in  $7 \times 24 = 168$  hours being 7 full days.

The original division of the circle of 360 degrees into  $2 \times 180$  degrees becomes redefined as  $3\frac{1}{2}$  days of 84 hours of daytime and  $3\frac{1}{2}$  days of 84 hours of nighttime.

The seven days of creation so are  $7 \times 12 = 84$  hours of daytime from morning to evening, followed by  $7 \times 12 = 84$  hours of nighttime from sunset to sunrise.

The fractal of the Genesis-Star-Genetic Code is defined by  $2 \times 7 \times 12 = 14 \times 12 = 168$  hours as:

$7+70+700+7,000+70,000+700,000+7,000,000+70,000,000+700,000,000+7,000,000,000+70,000,000,000+700,000,000,000+7,000,000,000,000=7,777,777,777,777$  full days of creation in one week of consecutive daytime and 1 week of consecutive nighttime.

There are so six periods of daytime from 7-70 and 70-700 and 700-7,000 and 7,000-70,000 and 70,000-700,000 and 700,000-7,000,000 followed by a mirror of half-time and 7,000,000-70,000,000 and 70,000,000-700,000,000 and 700,000,000-7,000,000,000 and 7,000,000,000-70,000,000,000 and 70,000,000,000-700,000,000,000 and 700,000,000,000-7,000,000,000,000

The alpha-sunrise as the morning of the 1<sup>st</sup> day of creation are the 7 days of the beginning and counting from left to right or clockwise with the omega-sunset of the 6<sup>th</sup> day being the 7,000,000 days at the 'Halftime Logos Mirror' of the daytime and mirroring the 6 days of daytimes in the 6 days of night times.

The 6<sup>th</sup> night of the 7,000,000 days so continues as the 6<sup>th</sup> night to the 70,000,000 days to begin the nighttime of the 5<sup>th</sup> full day and following the clockwise motion of the circle in the nighttime from 180 degrees to the 360 degrees of the 7,000,000,000 days to reset the 360 degrees in the 0<sup>th</sup> degree of the sunrise of the 1<sup>st</sup> day ending the nighttime of the 1<sup>st</sup> full day and completing the circle of the star-genetic time.

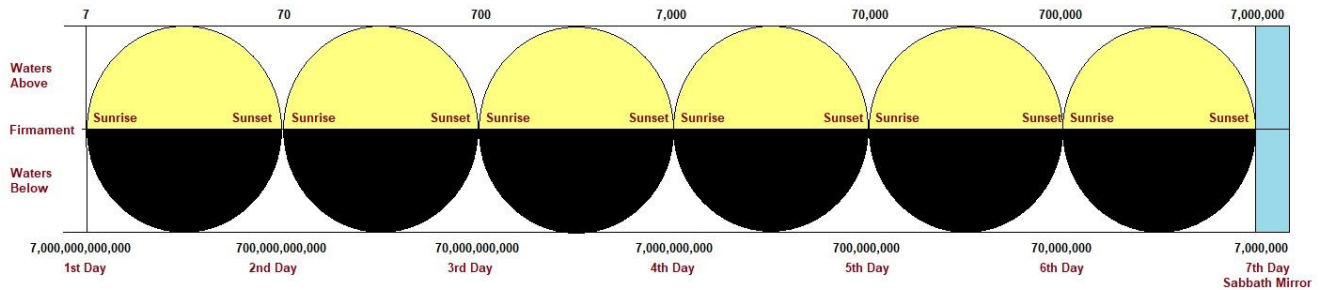

**The 1<sup>st</sup> day of star-genetic creation are 7 days and 7 Trillion nights.**

as 7 days and  $7,000,000,000,000/360=19.444\dots$  Billion Degree-Years 'DY' with 7 Trillion/ $365.2425=19.165$  Billion Civil Years 'CY'

{The Age of the universe as a multiverse, subject to quantum tunneling can be calculated as 19.12 Billion years in a cosmology of 12-dimensional supermembrane duality}

**The 2<sup>nd</sup> day of star-genetic creation are 70 days and 700 Billion nights.**

as 70 days and  $700,000,000,000/360=1.9444\dots$  Billion 'DY' with 700 Billion/ $365.2425=1.916\dots$  Billion 'CY'

{A 'electromagnetic higher dimensional universal age' of 19.12 Billion years defines an 'intersection' (return of the electromagnetic light path) interval of 2.24 Billion years for a lower dimensional universal age of  $19.12-2 \times 2.24=14.64$  Billion years coincident with an age of planet Earth of 2.24 billion years for the onset of prokaryotic unicellular lifeforms transmutating into eukaryotic multicellular lifeforms}

**The 3<sup>rd</sup> day of star-genetic creation are 700 days and 70 Billion nights.**

as  $700/360=1.944\dots$  'DY' with  $700/365.2425=1.916\dots$  'CY' and  $70,000,000,000/360=194.444\dots$  Million 'DY' with  $70 \text{ Billion}/365.2425=191.653\dots$  Million 'CY'

{200 Million years is a time marker for the evolution of the first mammals and diversification of dinosaurs in the transition from the Triassic into the Jurassic era of the Mesozoic time period. The time required for the local star system of Rahlol to complete a cycle of rotation about the center of the Milky Way galaxy takes about 236 Million years}

**The 4<sup>th</sup> day of star-genetic creation are 7,000 days and 7 Billion nights.**

as  $7,000/360=19.444\dots$  'DY' with  $7,000/365.2425=19.165\dots$  'CY' and  $7,000,000,000/360=19.444\dots$  Million 'DY' with  $7 \text{ Billion}/365.2425=19.165\dots$  Million 'CY'

{20 Million years ago in the evolution of life on planet Earth represents a nexus point towards the end of the Miocene era and initiates the evolution of apes (Hominoidea) from an earlier primate genomatrix (Old World Monkeys)}



**The 5<sup>th</sup> day of star-genetic creation are 70,000 days and 700,000 Million nights.**

as  $70,000/360=194.444\dots$  'DY' with  $70,000/365.2425=191.653$  'CY' and  $700,000,000/360=1.944\dots$  Million 'DY' with  $700\text{ Million}/365.2425=1.916\dots$  Million 'CY'

{The Hominoidea-Hominidae-Homininae-Hominini-Hominina-Homo taxonomy of human evolution had passed the Australopithecine and Homo Habilis nexus marker to emerge the homo erectus or 'upright man' as archaic forerunner of homo sapiens 2 Million years ago}

**The 6<sup>th</sup> day of star-genetic creation are 700,000 days and 70,000 Million nights.**

as  $700,000/360=1944.444\dots$  'DY' with  $700,000/365.2425=1916.534\dots$  'CY' and  $70,000,000/360=194,444.444\dots$  'DY' with  $70\text{ Million}/365.2425=191,653\dots$  Million 'CY'

{200,000 years ago, characterized the appearance of Homo Sapiens or 'wise man' as evolved from Homo Sapiens-(Devosonian, Homo Neanderthalensis, Homo Heidelbergensis) in the form of 'Anatomically Modern Human' AMH (Cro-Magnon Man) in the Late/Upper Pleistocene period of the Quaternary era of geology}

**The 7<sup>th</sup> day of star-genetic creation are 7,000,000 days and 7,000,000 nights.**

as  $7,000,000/360=19,444.444\dots$  'DY' with  $7\text{ Million}/365.2425=19,165.349\dots$  'CY' and  $7,000,000/360=19,444.444\dots$  'DY' with  $7\text{ Million}/365.2425=19,165.349\dots$  Million 'CY'

{The 'last ice age' and period of glaciation (Younger Dryas) in the Holocene epoch 12,000 years ago is defined within the last precessional cycle of precession, defined by a simple day-count calendar of  $9,360,000=65 \times 144,000$  day-kin of the Maya from [-52.0.0.0.0=4Ahau 3Kayab as 01Mar23,615 BCG (Gregorian proleptic)/27Aug23,615 BCJ (Julian proleptic)= 25Sivan-19,854] to a Midpoint of a 65 Baktun Precessional Cycle defining the glaciation for the dates [-20.10.0.0.0 =4Ahau 13Muan as 27Jul10,802 BCG/18Oct10,802 BCJ=16Elul-7041] to [13.0.0.0.0= 4Ahau 3Kankin as 21Dec2012 ADG/08Dec2012 ADJ=8Teveth5773] as a  $9,360,000/360=26,000$  'DY' with a  $9,360,000/365.2425=25,626.809\dots$  'CY' count of years for the completion of the fifth of five such precessional cycles of time.}

Dedicated to the supermembrane AbbABaaB for the reconfiguration of an old world into a new world! --- Queanbeyan, New-South-Wales; Australia; July 4<sup>th</sup>, 2020, with November 12<sup>th</sup> - December 21<sup>st</sup>, 2021





This video describes Agenda 2025 from the perspective of a reconfigured human genomatrix of an old world planetary civilization.

It can so be considered as a legacy from the stars and the creation of the universe with its constituent galactic structures and star centered planetary systems. Agenda 2025 represents a higher- and inter dimensional energy signature flowing in parallel to a planetary restricted Agenda 2010-2020-2030 described in the universal logos context in this video.

The video begins with a political-religious introduction (by Tom Horn), regarding the 'hidden aspects' and workings of the cultural background matrix for the history of planet Earth by the use of symbols, psychology and science. This programming control is known as a 'secret cabal' or technocratic global web of elitist control or 'hidden hand'.

The video is continued in a description of the starhuman genomatrix in the context of universal physicalized consciousness as a form of quantum consciousness responsible for the creation of the universe.

The video then completes in a detailed history of the testimony from the stars as a legacy for the human ancestors in bodyform, being the inheritors and descendants of the starhuman mind.

sirebard, August 13th, 2021

[Agenda 2025 - A Starhuman Genomatrix Legacy \(bitchute.com\)](http://bitchute.com)

[\(PDF\) Dirac's Magnetic Monopole and the Energy Density of the Universe from Dark Matter with Dark Energy | Anthony P Bermanseder - Academia.edu](#)

There is no copyright and any researcher or organization wishing to utilize any or all parts of this treatise are welcome and invited to do so without referencing the original documentation.

The information here disseminated is free for all to use in their own works and research as extensions and enhancements with respect and in view of their own academic, scientific, or commercial advancements and endeavors.



**All truth passes through three stages:**

1. First, it is ridiculed.
2. Second, it is violently opposed.
3. Third, it is accepted as being self-evident.

~ Arthur Schopenhauer (1788 – 1860)

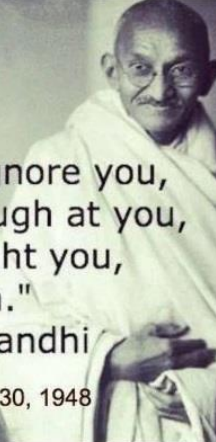

**"First they ignore you, then they laugh at you, then they fight you, then you win."**

-Mahatma Gandhi

Oct. 2, 1869 - Jan. 30, 1948

## Kuhn Cycle

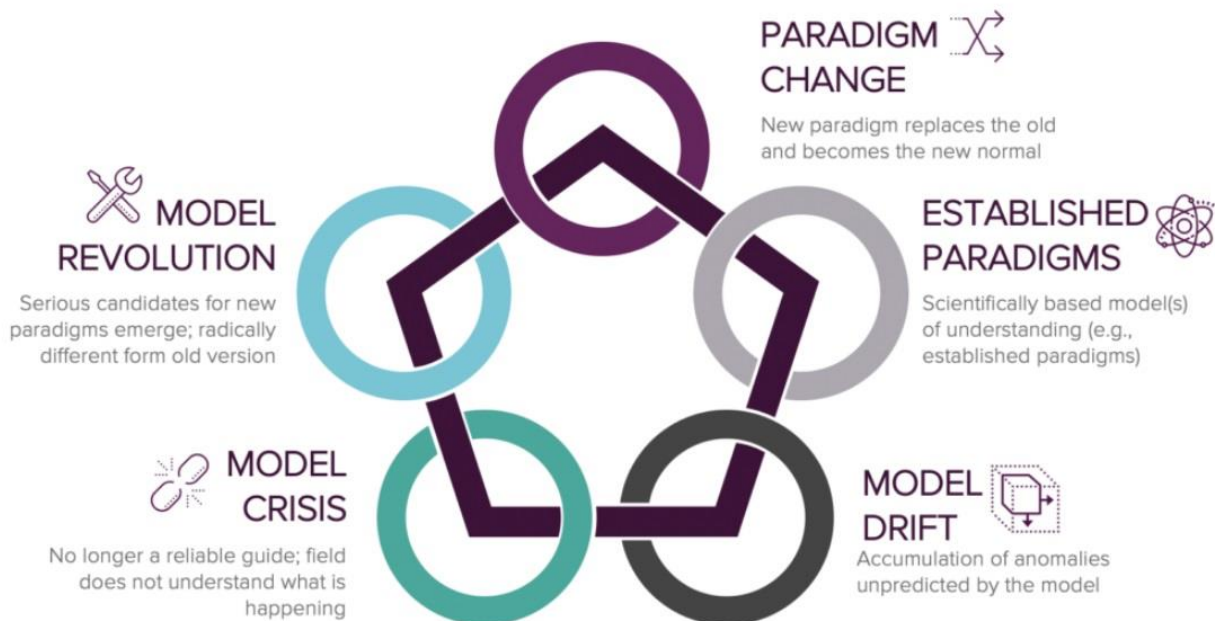

**January 16<sup>th</sup> - 18<sup>th</sup> - 24<sup>th</sup> - 26<sup>th</sup> to March 7<sup>th</sup>, 2022 {1975 - 1985 – 2010 - 2025}**

### **The Pregnancy and Gestation of the New World in the Womb of the Old World**

February 26th, 1776---July 4th, 1776-January 2nd, 1777---

February 22nd, 2022---July 11th, 2022---December 29th, 2022

for Pluto Return of 246 years at D-R-D-D-R-D at 27 degrees 34'



Look inside

## God Reborn - The Birth of God as a Superbrane: A Story of Intelligent Design and the Creation of the Quantum Universe

Paperback – February 22, 2022

by Anthony Paul Bermanseder (Author)

See all formats and editions

Kindle  
\$0.00

Paperback  
from \$40.00

Read with Kindle Unlimited to also enjoy access to over 1 million more titles \$5.00 to buy

1 New from \$40.00

**The question of creation as quantum fluctuation ex nihilo is answered as a creation ex UniPhysCon as the quantum entanglement of omnispaces in the form of universal physicalized consciousness.**

A claim to have some answers to pertinent and profound questions in regards to the perennial quest of the human race to understand itself in being and in mind can be no statement of whimsicality.

Such a proposition demands a thorough investigation of the issues at hand; not a one-sided or biased examination of selected data

Read more



See all 2 images

Follow the Author



Anthony Paul Bermanseder

+ Follow

Print length



359 pages

Language



English

Publication date



February 22, 2022

Dimensions



8.5 x 0.85 x 11 inches

ISBN-13



979-8421360285

See all details

### Product details

ASIN : B09T61XGRT

Publisher : Independently published (February 22, 2022)

Language : English

Paperback : 359 pages

ISBN-13 : 979-8421360285

Item Weight : 2.26 pounds

Dimensions : 8.5 x 0.85 x 11 inches

**Book of Enoch (Ethiopian Version) and Dead Sea Scrolls (Qumran) with Daniel 7x70 = 490 in 1980 Year Timewarp 31-46 AD---2011-2026 AD of the Hour 15 Days as Years 3½ Times as Days = 84 Hours as 1260/15**

**10 Week Prophecy of 7000 Years as 7x70x1000 = 490x1000 = 7x10x7x1000 = 7x(7+3)x7x1000 June 12th, 2015 --- August 8th, 2025 as 3710 = 3660 + 50 Jubilee = 3650 + 3 Leapdays + 7 days + 49 + 1 days**

View: <https://youtu.be/ucmUeJrds>

0-371 1st Week	371-742 2nd Week	742-1113 3rd Week	1113-1484 4th Week	1484-1855 5th Week	1855-2226 6th Week	2226-2597 7th Week	2597-2968 8th Week	2968-3339 9th Week	3339-3710 10th Week
7x53=371 7th part = Jubilee+3½	7x53=371 7th part = Jubilee+3½	7x53=371 7th part = Jubilee+3½	7x53=371 7th part = Jubilee+3½	7x53=371 7th part = Jubilee+3½	7x53=371 7th part = Jubilee+3½	7x53=371 7th part = Jubilee+3½	7x53=371 7th part = Jubilee+3½	7x53=371 7th part = Jubilee+3½	7x53=371 7th part = Jubilee+3½
12Jun2015- 25Apr2016- 17Jun2016	17Jun2016- 01May2017- 23Jun2017	23Jun2017- 07May2018- 29Jun2018	29Jun2018- 13May2019- 05Jul2019	05Jul2019- 18May2020- 10Jul2020	10Jul2020- 24May2021- 16Jul2021	16Jul2021- 30May2022- 22Jul2022	22Jul2022- 05Jun2023- 28Jul2023	28Jul2023- 10Jun2024- 02Aug2024	02Aug2024- 16Jun2025- 08Aug2025
Enoch 7000 0-700	Enoch 7000 700-1400	Enoch 7000 1400-2100	Enoch 7000 2100-2800	Enoch 7000 2800-3500	Enoch 7000 3500-4200	Enoch 7000 4200-4900	Enoch 7000 4900-5600	Enoch 7000 5600-6300	Enoch 7000 6300-7000
3925BC- 3225BC	3225BC- 2525BC	2525BC- 1825BC	1825BC- 1125BC	1125BC- 425BC	425BC- 274/275AD	274/275AD- 974/975AD	974/975AD- 1674/1675AD	1674/1675AD- 2374/2375AD	2374/2375AD- 3074/3075AD
Enoch 93.3	Enoch 93.4	Enoch 93.5	Enoch 93.6	Enoch 93.7	Enoch 93.8	Enoch 93.9	Enoch 91.12-13	Enoch 91.14	Enoch 91.15-16
Old World Midweek 3575BC	Old World Midweek 2875BC	Old World Midweek 2175BC	Old World Midweek 1475BC	Old World Midweek 775BC	Old World Midweek 75BC	Old World Midweek 624-625	Old World Midweek 1324-1325	Apocalypse Midweek 2024-2025	New World Midweek 2724-2725

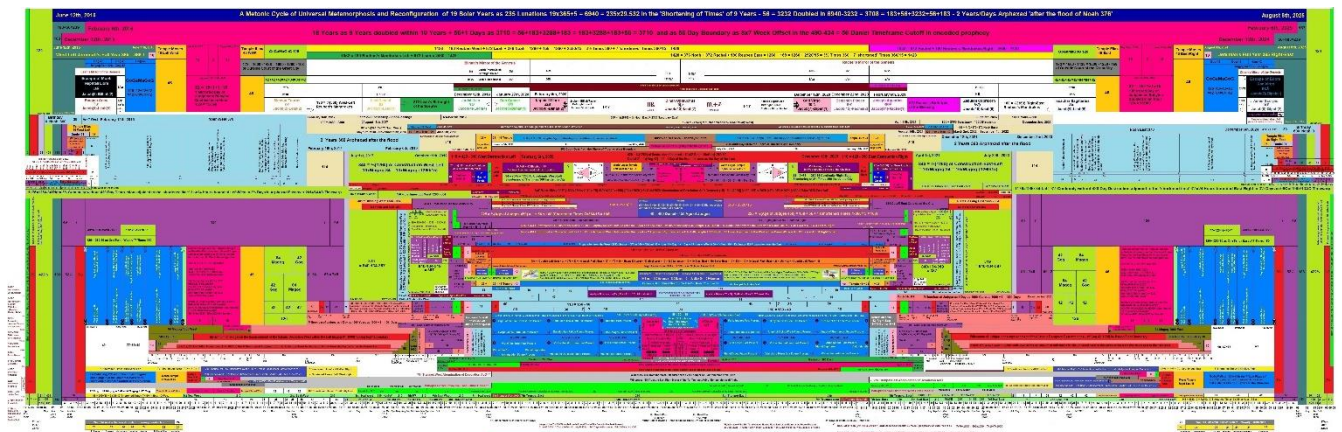

<https://www.cosmosdawn.net/threads/the-fulfilment-of-the-apocalypse-in-a-warping-of-time.9961/page-2#post-35833>

# Intimidations

To feel offended by truth and by deceptions.

The p1b knows you as ignoramus in secret and asks you to relax because you are clever and aware and educated.

The P1B knows you as ignoramus in openness and asks you not to relax to become clever and aware and educated.



AbraXasias: December 14th, 2016

{Gospel of Thomas - Lambdin-Ag Hammadi}

(39) Jesus said, "The pharisees and the scribes have taken the keys of knowledge (gnosis) and hidden them. They themselves have not entered, nor have they allowed to enter those who wish to. You, however, be as wise as serpents and as innocent as doves."

Sap1q#115:

Jesus said, "You can delude yourself any way you wish; but if you do not eat the lion of truth, then your selfimage will not be able to stride in the wisdom of the Father and you will mirror the darkness in the world back to yourself and you will be that darkness."

Sap1q#116:

Jesus said to the apostles: "If the people come up to you in numbers, sap1q, tell us your secrets, tell us your secrets; then reply to them, that you cannot do so for reason of the secrecy. Tell them, that should they know, they would become insane.

But if some persist and ask you privately; then share the secrets with them in measure of their willingness to become insane in the world."

1984-----2000-----2016-----2020	} 1958+72 1989+31 2025-36 2030-5
989/990---1005/1006---1021/1022---1025/1026	
68C-----11A 0-----27A 0-----31A 0	

