

Chapter Four

The Resurrection of Jesus Universal Logos and Radiationmass

For many years people have wondered about how mass relates to electric charge and how the fundamental interaction of electromagnetism can or is unified with gravitation. The workings of electricity are well studied, but the nature of an electric charge always remained a mystery.

Look at any textbook or encyclopedia and it will have little to say about what an electric charge actually is. As stated previously, all electric charges are intrinsically coupled to particles carrying mass, such as a negatively charged electron and a positively charged proton, (by convention it could also be called positive as the opposite of negative the other way around) which together form the basic building block for all physical chemistry in the atom of Hydrogen.

The great conundrum in Big Bang Physics and the standard cosmology then becomes the insistence that matter and the physical parameter of mass must precede that of electromagnetic radiation EMR in general and that of light in particular; because all EMR is generated by accelerating electrically charged particles, say as centripetally dynamic solar protons. So because electric charge does not exist in a form not coupled to mass, the creation of the universe must have proceeded from a 'wormhole string/brane singularity' or vortex experiencing a kind of 'quantum fluctuation' or Planck-Length Oscillation - this singularity containing all of the matter energy, which would experience a time evolution and become the experienced and observed universe in toto.

And so, as it is generally presumed by the terrestrial cosmologists, the existence and purpose of the universe and creation can be reduced to the primordial seed of mass, with the appearance of electromagnetic radiation becoming a consequence of the pre-existence of the matter seedling, due to its dependency on mass coupled Coulombic electric charges to exist a priori.

So how did Jesus of Nazareth resurrect from the dead and a real death, defined by his soul leaving his body and no longer quasi-attached in an extended mind-soul-body tri-unification. In the quote below, describing a scenario of Wednesday, March 28th, 31AD-Julian from Noon to 3pm, Jerusalem time; Jesus knew, that his soul physical had 'no place to go' as a 'journey of the soul' in the underworld of say a Greek Hades, a Roman Pluto or the judgement hall of Osiris, Maat and Anubis in Egyptian folklore. And so, unlike a normal ignorant (or sinful) human, who at the point of its soul's transformation from one mode of beingness into the other and remaining ignorant about its origin or destiny, Jesus became 'truly lost' within himself and his soul's chosen body morph host.

The VEIL of the EVIL rent in twain to allow the LIVE Temple as his own body to now become a new underworld or a River Styx the dead ones had to traverse to gain access into the 'new world' created by the Body morph of Jesus destined to resurrect as a matter-spirit hybrid form with a Merkabah often described as a light body. It was AFTER the Resurrection, which occurred 84 hours after Jesus 'gave up the ghost' at 3pm, March 28th, 31AD Jerusalem time and so on the original Easter Sunday at 3am, April 1st, 31AD, Julian Jerusalem time, that the 'saints' 'came out of their graves' in Matthew.27.53 and archotyping and defining the new underworld for all the dead alive ones in the world of the light bodied souls in contrast to the alive dead souls of the physical incarnations.

Matthew 27:45-53 - King James Version (KJV)

45Now from the sixth hour there was darkness over all the land unto the ninth hour. 46 And about the ninth hour Jesus cried with a loud voice, saying, Eli, Eli, lama sabachthani? that is to say, My God, my God, why hast thou forsaken me?

47Some of them that stood there, when they heard that, said, This man calleth for Elias. 48 And straightway one of them ran, and took a sponge, and filled it with vinegar, and put it on a reed, and gave him to drink.

48The rest said, Let be, let us see whether Elias will come to save him.

49Jesus, when he had cried again with a loud voice, yielded up the ghost.

50And, behold, the veil of the temple was rent in twain from the top to the bottom; and the earth did quake, and the rocks rent;

51And the graves were opened; and many bodies of the saints which slept arose,

52And came out of the graves after his resurrection, and went into the holy city, and appeared unto many.

John 2:13-22 - King James Version (KJV)

13And the Jews' passover was at hand, and Jesus went up to Jerusalem.

14And found in the temple those that sold oxen and sheep and doves, and the changers of money sitting:

15And when he had made a scourge of small cords, he drove them all out of the temple, and the sheep, and the oxen; and he poured out the changers' money, and overthrew the tables;

16And said unto them that sold doves, Take these things hence; make not my Father's house an house of merchandise.

17And his disciples remembered that it was written, The zeal of thine house hath eaten me up.

18 Then answered the Jews and said unto him, What sign shewest thou unto us, seeing that thou doest these things?

19Jesus answered and said unto them, Destroy this temple, and in three days I will raise it up.

20Then said the Jews, Forty and six years was this temple in building, and wilt thou rear it up in three days?

21But he spake of the temple of his body.

22When therefore he was risen from the dead, his disciples remembered that he had said this unto them; and they believed the scripture, and the word which Jesus had said.

The actual details in terms of Quantum Chromo Dynamics (QCD) and a related Quantum Geometry defining the basics of the Dragon physics can be examined in the following essay describing the Radiation Mass template as a constituent of the Unified Field of the Universal Gauge physics and as say an advanced form of wave mechanics as a colour physics of the quantum.

There are so not just two but three elementary 'cosmic charges' with the well-studied 'charges' of mass/matter and that of electric current becoming supplemented to by the 'cosmic colour charge' also known as the gluon charge of the strong nuclear interaction and as the Thuban magneto charge. The key to electric charge and mass unification is colour charge as a magnetic missing basic fundamental interaction or force.

Jesus' soul had the space awareness and consciousness to actually hybridize his corpse on the elementary interaction level blending the colours of his atomic constituents from the subatomic premise of his own Merkabah or body creation.

Just as your body grows and develops from a cosmic template using biochemistry and the genetic code program so can you regrow this from the conception point of the soul into a body form. When people die and the soul leaves the body, the colour structures remain separate in their respective Fermion-Boson Interaction gauge formations of half quantum spin and integral quantum spin respectively.

And as quantum spin defines the spin angular momentum in the form of Planck's Constant $h/2\pi$ with units Js for its linearization into $mvr=mr^2\omega=2\pi fmr^2$, the string-brane frequency modulations bounded by Abba's f_{ps} and Baab's f_{ss} can become applied to the subatomic nature of the constituents brought together to construct a body morph or Merkabah.

"Gospel of Thomas" wrote:

(85) Jesus said, "Adam came into being from a great power and a great wealth, but he did not become worthy of you. For had he been worthy, he would not have experienced death."

The details engage the nature and structure and a quantum geometry of the fundamental constituents of both matter and of EMR, say visible light or infrared EMR etc. and involve particular physical characteristics of fermions of quantum half spin and bosons of quantum integral spin. The Higgs Boson is a 0-spin boson but IF it spun it would become a Restmass Photon, unifying matter with light.

So now when someone dies with unified colour structures, physical 'death' could not occur as it does in the case of separated colour structures.

Because matter (and antimatter however unnecessary as its image template in chirality) are one set of colours Yellow-Cyan-Magenta (YCM) they form a unification and a unification which always is electrically charged in its quark constituency.

Radiation templates always remain in an uncharged electric state, but in their gauge or 'source-sinked' nature, they can be colour charged, just as the gluons are known to be and in a complementary color triplet called Red-Green-Blue (RGB).

So called mesons exist in short-lived hybrid states combining one color of each trio as a state-antistate coupling with Red-Cyan and Green-Magenta and Blue-Yellow forming those coupling states.

The RGB trio also remains self-contained in a corpse and so the body eventually 'sees corruption' and turns to dust and ashes or poetically just 'fades away' both physically and in remembrances. So, the YCM is Coulomb-electric charged but the RGB trio is not. This in a primitive way defines the Body as YCM and the 'Spirit' as RGB in the Mind-Body divide and a dichotomy of colour separations.

The key to the Resurrection is to not keep RGB and YCM separate, but to mix them in a consistent and logical way, derived from the quantum geometry of the subatomic physics.

As all 3 colours are so blended or mixed the short-lived mesonic self-state is circumvented in a true unification physics of the colours or chromas.

This Jesus could do and actually did, because he had the full remembrance of his own conception and physical origins. He resonated physically with Baab, and he resonated 'spiritually' or better said in Electromagnetic Monopolar fashion with Abba.

Because his own Merkabah frequency perfectly could match both the matter frequency f_{ss} and the spirit vibration f_{ps} , his soul had nowhere to go except reconfigure his own previously conceived and environmentally constructed and fed body form.

This is the story behind the physics of the 'Shroud of Turin' and the nature of the holographic universe.

<https://youtu.be/pdwnTpWXi3M>

https://youtu.be/tZAOJ3D_NN8

<https://youtu.be/sJymwctqo-A>

<https://youtu.be/JBDuKZSgDSI>

<https://youtu.be/LLnClp3OVmE>

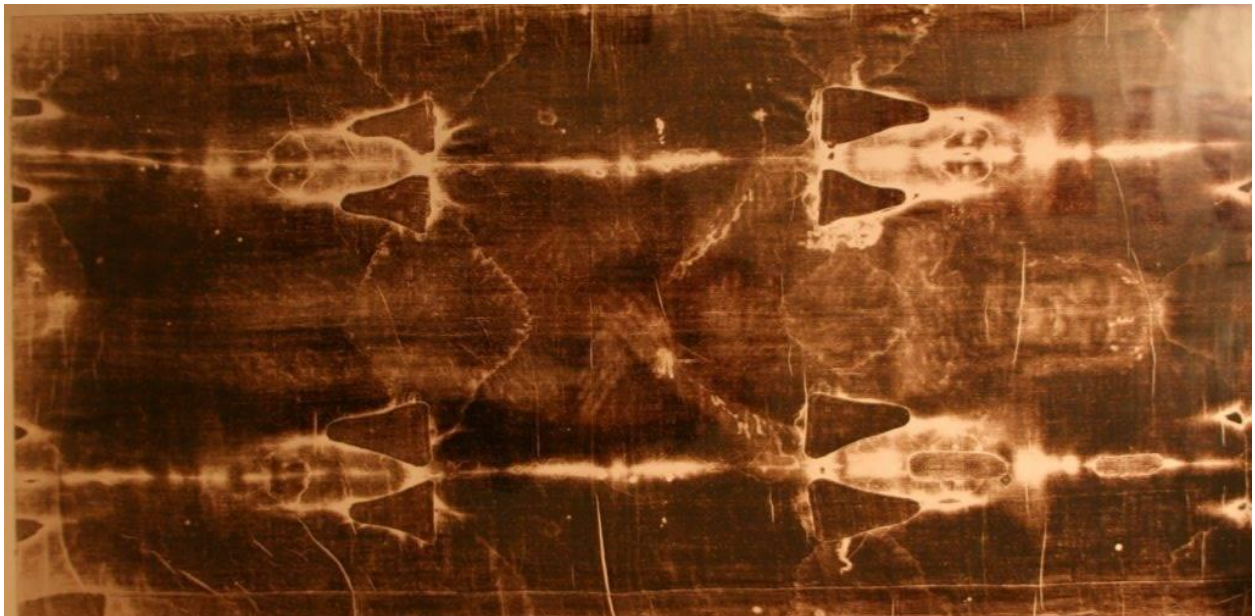

The biophotonic EMR emission from Jesus' DNA allowed synthesis resonance with the Abba-Eps wormhole frequency of creation as the maximized eigen energy state of the source energy consciousness quantum in the modulation with a Luminosity fundamental constant L_o at the frequency of 6×10^{14} Hz and a wavelength of 600 nm. This Luminosity Constant is derived from the Algorithm of Creation as the 4th or 7th of 10 fundamental constants of nature.

This algorithm or code is defined as a binary code of the operations of Addition (+), Multiplication (by $1+1+1=3 \times 1$) and Exponentiation ($3 \times 3=3^2$) and is used as a secondary algorithmic code to 'find' the missing elements of SEps (as a Fibonacci-Lucas Sequence) as the constituents of SEps* in the attempt to complete and manifest the generic supersymmetry of the Mathimatia.

Application of this algorithm {<http://www.cosmosdawn.net/forum/ind...s-and-algorithms-of-dragon-cosmogogenesis.636/> (30) (PDF) [The Origins of the Mathimatia and Four Pillars of Creation | Anthony P Bermanseder - Academia.edu](http://www.academia.edu/39210286/The_Origins_of_the_Mathimatia_and_Four_Pillars_of_Creation) }
https://www.academia.edu/39210286/The_Origins_of_the_Mathimatia_and_Four_Pillars_of_Creation }

produces 10 number triplets, carrying elements of SEps* in various configurations: SEps-SEps*

Constantset: $\{(266561)=26 \times 65^{61}=E; (15,16,18)=[15 \times 16^{18}]^{-1}=k_B; (14,15,24)=14 \times 15^{24}=A^2;$
 $(15,10,32)=[15 \times 10^{32}]^{-1}=h; (11)=11; (9,10,16)=9 \times 10^{16}=c^2; (6,10,15)=[6 \times 10^{15}]^{-1}=L_o; (7)=7; (6)=6; (4)=4\}$

The wavelength for biophoton emissions ranges from 200 nm to 750 nm from the High to Low Ultraviolet to the optical EMR spectrum (Gurwitsch and Popp - [Biophoton - Wikipedia](#)).

Coherent (Laser) Orange Light as the mixing of $R+Y=O$ is the first tertiary triplet eigenstate and for a wavelength of 6000 Angstroms and a frequency of 5×10^{14} manifests the quantum wave mechanics as an energy transduction from the formulation $f_{ps} \times \text{Luminosity Constant } L_o = \text{Transduction frequency}$.

$\{f_{ps}\}\{L_o\} = 3 \times 10^{30} \text{ cycles} / 6 \times 10^{15} = 5 \times 10^{14} \text{ cycles}$ as this frequency of the tertiary triplet energy manifestation in a dynamic spacetime of 4 spacial and one time dimension embedded in the 12-dimensional F-M-C spacetime matrix.

This enables a resonant synergy and convolution between the DNA biophotonic or mitogenetic EMR emanating from the corpse of Jesus as an output and the input from the Abba-Father-Eps EMMR to manifest in the Unified Field of Quantum Relativity.

Jesus bodyform is a matter YCM conglomeration and is coupled to his 'soul' as his particular physicalized consciousness energy self-state (YY)(CC)(MM){-1} matter blueprint as his atomic-molecular structure. Jesus' YCM bodyform emits a biophotonic 'death signature and imprint' and merges with the 'life signature and imprint' of the Abba-Eps source bosonic and monopolar RGB{+1} EMMR.

As Jesus' 'soul' frequency is the same as that of the creation frequency of the Quantum Big Bang Singularity event; this sourcesink energy resonance allows the merger and creation of the Radiationmass bodyform in the merger of the primary and secondary colour triplet to manifest the 'Body of the Resurrection'.

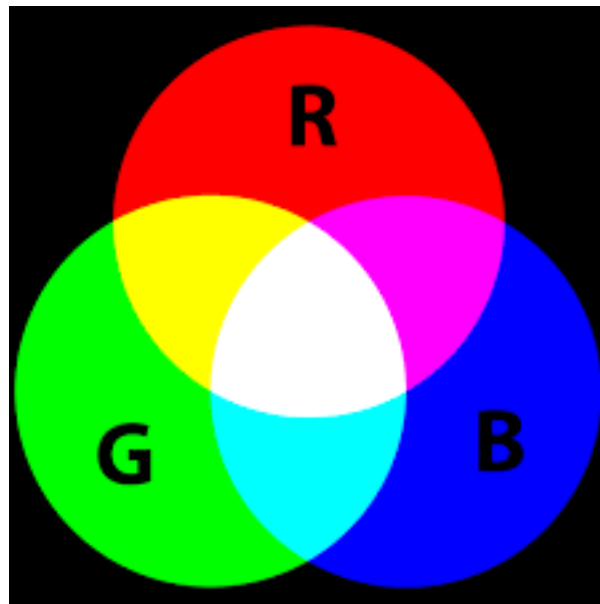

**Abba-Eps Continuity for Left-Right Entropy Arrow of forward Time in EMMR Lightpath.
Manifestation of (Virtual) Electromagnetic Monopolar Radiation EMMR as Colour-Charged massless Goldstone Boson Interaction.**

**Baab-Ess Discontinuity for Right-Left Negentropy Arrow of backward Time in Anti-EMMR Lightpath.
Encoded as the 'Retracing of the Creator's steps' in Eze.28.13-19 with Isa.14.12-14 - Masoretic texts and descriptive for a 'Breaking of Universal Source bosonic Supersymmetry'.**

Manifestation of (Virtual) Gravitational Radiation GraveR as Colour-Charged massless Goldstone Boson Interaction in the Graviton {quantum spin -2} to negate the Eps-photon {+1} long-range continuity with the Ess-antiphoton {+1} long-range discontinuity.

The Continuity long-range Abba-Eps photon transforms the original Eps-photon into a short-range and nuclear (asymptotically magnetically confined) Eps-Gluon of quantum spin {+1}.

Suppression of the Baab-Ess Antiphoton as Source Bosonic agency for anti-radiation also suppresses cyclic permutative Antimatter MCY=CYM=YMC=MCY and allows the emergence of cyclic permutative Matter YCM=CMY=MYC=YCM.

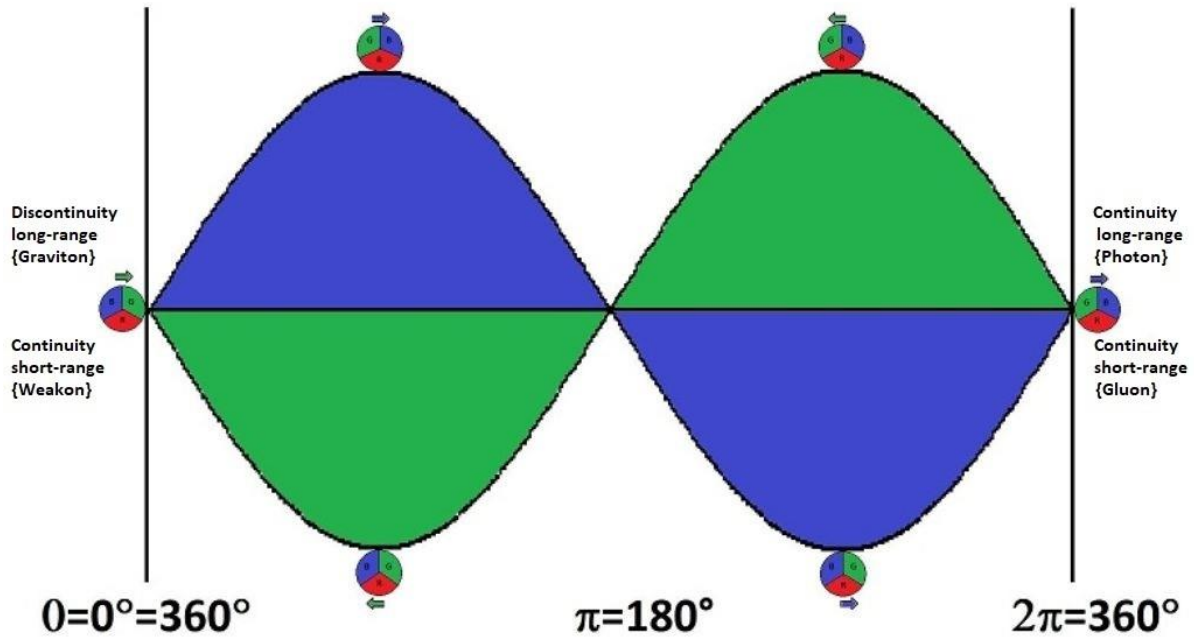

Abba Mirror
 Eps=Energy Primary SourceSink
 {God CreatorCreation}

Inflexion Nexus

Baab Mirror
 Ess=Energy Secondary SinkSource
 {AntiGod-Satan CreationCreator}

Father White Hole Energy Source-Sink
 Universal 12D-11D-Supermembrane
 Vibratory High Frequency $f_{ps} = 1/f_{ss}$
 Creation Quantum Big Bang Wormhole
 Weyl-Frequency 3×10^{30} Hertz

Mother Black Hole Energy Sink-Source
 Universal 10D-11D-Supermembrane
 Winding Low Frequency $f_{ss} = 1/f_{ps}$
 Creation Quantum Big Bang Anti-Wormhole
 Mass-Eigen-Frequency $3.33... \times 10^{31}$ Hertz



Abba-Eps Photon{+1} long
 EMI: Monopolar EMR
 SNI: Gluon{+1} short

Baab-Ess Photon{+1} short
 Monopolar Anti-EMR
 Suppressed Anti-Radiation
 GI: Graviton{-2} long

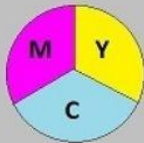

Matter Template $\{\pm\frac{1}{2}\}$
 Basic Nucleon-Neutron
 YCM=CMY=MYC=YCM
 Cyclic Permutative

Anti-Matter Template $\{\pm\frac{1}{2}\}$
 Basic Anti-Nucleon Anti-Neutron
 MCY=CYM=YMC=MCY
 Anticyclic Permutative

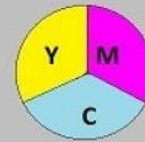

Anti-Neutrino Template $\{+\frac{1}{2}\}$
 (RR)(GG)(BB)=(GG)(BB)(RR)=...
 Cyclic Permutative
 W-minus Matter Weakon {+1}
 = YCM $\{+\frac{1}{2}\}$ + (RR)(GG)(BB) $\{+\frac{1}{2}\}$
 WNI: Weakon{+1} short

Neutrino-Template $\{-\frac{1}{2}\}$
 (BB)(GG)(RR)=(GG)(RR)(BB)=...
 Anticyclic Permutative
 W-plus Anti-Matter Weakon{-1}
 = MCY $\{-\frac{1}{2}\}$ + (BB)(GG)(RR) $\{-\frac{1}{2}\}$
 WNI: Weakon{-1} short

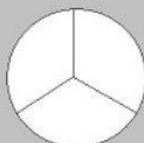
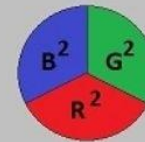

Graviphoton GP{-1} short
 Dark Matter Template
 QGI: Quantum Gravity short

Higgs Boson HB{0} short
 RestMass Photon RMP{-1}
 Universal Consciousness Agent

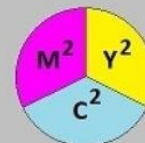

The Creation of the Graviton in the Unified Field Of Quantum Relativity

Quantum Gravity emerges from the Conservation of Gauge Supersymmetry of SourceSink Energy, of Colour Charges and Quantum Spin from Templates of a Quantum Geometry

{Encoded and decoded from Ezekiel.28.13-19 with Isaiah.14.13-14 - masoretic texts}

Quantum Spin and Colour-Charge Supersymmetry Conservation:

$Eps-rgb\{+1\} + Ess-RBG\{+1\} + Graviton-RBG\{-2\} + Gluon-RGB\{+1\} + RestMass\ Photon\{-1\}$
 $= (R+R)(G+B)(B+G)\{-2\} + (R+R)(B+G)(G+B)\{-1\} + Dark\ Matter\ Graviphoton\{-1\}$
 $= 2\{(RR)(C)(C)\}\{0\} + \{(YY)(CC)(MM)\}\{0\} = Supersymmetry\ Unification\ in\ colour-anticolour\ neutralization$
 $RC=GM=BY=0$ net colour charge with colourless Graviphoton.

RMP $\{-1\}$ so becomes the source bosonic Dark Matter/Physicalized Consciousness Energy agency from the scalar Higgs Boson HB $\{-\{(YY)(CC)(MM)\}\{0\}$ bifurcating into a scalar bosonic ylemic di-neutron/neutronium pairing YCM $\{+1\} + YCM\{-1\} = HB\{0\}$.

The colourless Graviphoton GP $\{-1\}$ so unifies the Goldstone Boson Interactions of long-range Electromagnetism (EMI) and Gravitation (GI) with the short-range Strong (SNI) and Weak (WNI) Nuclear Goldstone Boson Interactions.

The GP $\{0\}$ then creates the Higgs Boson HB $\{0\}$ in colour charging the HB $\{0\}$ with the doubled Matter quantum geometric blueprint YCM, doubled to account for the suppression of Antimatter with Anti-Radiation.

With the Quantum Big Bang Singularity (QBBS) creation event and the emergence of the physicalized Universe, the Dark Matter Graviphoton assumes the identity of the RestMass Photon or RMP $\{-1\}$ as the sourcesink agency for the fifth universal interaction of Physicalized Universal Consciousness under the parameters of the original pre-spacetime definitions for initial and boundary conditions as given by the Dirac String and the Dirac magnetic Monopole from the timespace of the Planck epoch preceding the QBBS.

The right-handed ylemic neutron boson or neutronium manifests the Matter Weakon
 $W\text{-minus}\{+1\} = YCM\{+\frac{1}{2}\} + \{(RR)(GG)(BB)\}\{+\frac{1}{2}\} = Leptonic\ Electron\{+\frac{1}{2}\} + Anti-Neutrino\{+\frac{1}{2}\}$

The left-handed ylemic neutron boson or neutronium manifests the Antimatter Weakon
 $W\text{-plus}\{-1\} = MCY\{-\frac{1}{2}\} + \{(BB)(GG)(RR)\}\{-\frac{1}{2}\} = Leptonic\ Positron\{-\frac{1}{2}\} + Neutrino\{-\frac{1}{2}\}$

With the Quantum Big Bang Singularity (QBBS) creation event and the emergence of the physicalized Universe, the Dark Matter Graviphoton assumes the identity of the RestMass Photon or RMP $\{-1\}$ as the sourcesink agency for the fifth universal interaction of Physicalized Universal Consciousness under the parameters of the original pre-spacetime definitions for initial and boundary conditions as given by the Dirac String and the Dirac magnetic Monopole from the timespace of the Planck epoch preceding the QBBS.

The right-handed ylemic neutron boson or neutronium manifests the Matter Weakon
 $W\text{-minus}\{+1\} = YCM\{+\frac{1}{2}\} + \{(RR)(GG)(BB)\}\{+\frac{1}{2}\} = Leptonic\ Electron\{+\frac{1}{2}\} + Anti-Neutrino\{+\frac{1}{2}\}$

The left-handed ylemic neutron boson or neutronium manifests the Antimatter Weakon
 $W\text{-plus}\{-1\} = MCY\{-\frac{1}{2}\} + \{(BB)(GG)(RR)\}\{-\frac{1}{2}\} = Leptonic\ Positron\{-\frac{1}{2}\} + Neutrino\{-\frac{1}{2}\}$

The left-handed neutronium can also decay into a left-polarized neutron pair in the weak interaction CP-parity violations $YCM\{-\frac{1}{2}\} + YCM\{-\frac{1}{2}\} = YCM\{-1\}$

In Corollary, the right-handed neutronium can also decay into a right-polarized neutron pair in the weak interaction CP-parity violations $MCY\{+\frac{1}{2}\} + MCY\{+\frac{1}{2}\} = MCY\{+1\}$

As the original Antimatter is suppressed in the Unified Field; its manifestation can only occur in the process of Pair-Production, that is the creation of a matter-antimatter coupling, as in the creation of an electron-positron coupling from colourless mass-produced high energy photons, like gamma rays, merging two photons: $\text{photon}\{+1\} + \text{photon}\{-1\} = \text{Mesonic quark-antiquark state (BBYY=GGMM=CCRR)}\{0\} = \text{YCM}\{+\frac{1}{2}\} + \text{MCY}\{-\frac{1}{2}\}$.

The Higgs Boson $\{(YY)(CC)(MM)\}\{0\}$ then transforms its energy defined in the Unified Field of Quantum Relativity (UFoQR) by quantum geometric templates in a ylemic di-neutron and weakon distribution with a splitting of the bosonic neutronium coupling into left-polarized and right-polarized chiral neutrons which then decay into likewise chiral polarized proton-electron pairs with an oppositely polarized (anti)neutrino component as defined in the beta-decay modes of the weak nuclear interaction in the UFoQR.

Colour Triplicities for neutralizing Colour-Anticolour in 4 Mesonic Intermediate Energy Self-States in 8 Gluons

$\{WWW = \text{Pure White W Radiation Eigenstate}; WWB; WBW; BWW; WBB; BWB; BBW; BBB = \text{Pure Black B Eigenstate via mesonic WW; WB; BW; BB}\}$

Primary Triplet = {Red; Green; Blue} for Matter-Antimatter template creation: $R+G=Y; G+B=C; B+R=M$ in agency of $R+G+B = W = \text{White in Radiation for Planck's Law: Energy } E = h\{\text{Frequency}\} = hf$

Secondary Triplet = {Cyan; Magenta; Yellow} for colourless photon template creation: $Y+C=G; C+M=B; M+Y=R$ in agency of $Y+C+M = B = \text{Black in Mass for Einstein's Law: Energy } E = h\{\text{Mass}\}c^2 = mc^2$

Tertiary Double Triplet = {R+Y=Orange O; Y+G=Lime L; G+C=Turquoise T; C+B=Aquamarine A; B+M=Indigo I; M+R=Purple P} for the creation of Radiationmass in the Quantum Gravitational Interaction (QGI) of the RMP{-1} agency for Universal Physicalized Consciousness.

#	Gauge Boson	Colour Charge	Spin	Field
1	Eps-Photon	Cyclic RGB	+1	EMI
2	Ess-Antiphoton	Anticyclic BGR	+1	WNI
3	Graviton	Anticyclic BGR	-2	GI
4	Gluon	Cyclic RGB	+1	SNI
5	Restmass-Photon	Cyclic $Y^2C^2M^2$	-1	EMMI
6	Higgs-Boson	Cyclic $Y^2C^2M^2$	0	EMMI
	Dirac Monopole Mirror			

7	Anti-Higgs Boson	Anticyclic $M^2C^2Y^2$	0	Imaginary EMMI
8	Anti-Restmass-Photon	Anticyclic $M^2C^2Y^2$	+1	Imaginary EMMI
9	Anti-Gluon	Anticyclic BGR	-1	Imaginary SNI
10	Anti-Graviton	Cyclic RGB	+2	Imaginary GI
11	Ess-Photon	Cyclic RGB	-1	Imaginary WNI
12	Eps-Antiphoton	Anticyclic BGR	-1	Imaginary EMI

The cyclic right-handed Eps-Photon of Monopolar Radiation EMMR for the long-range Electromagnetic Interaction (EMI) is known as the 'virtual' photon of $U(1)$ - $SU(2)$ - $SU(3)$ Unitary gauge symmetry of the Standard Model of particle physics combining Quantum Field Theory (QFT) in Quantum Electrodynamics (QED) with Quantum Chromodynamics (QCD).

Its anti-particle would so be an anticyclic left-handed Ess-Photon in the supersymmetry of the Unified Field of Quantum Relativity (UFoQR).

The Quantum Relativity derives from the geometric topology creating and defining the elementary particle and gauge bosons in their quantum geometry in the timespace and preceding the string-membrane epoch in the mathimatia.

The cyclic RGB on one side of the Möbian strip would interact with its own image of the one-sidedness, however separated by the point-circle of the one-dimensional thickness of the Möbian geometry in the spacelessness or imaginary space of timespace.

The self-intersection of the Eps-Photon with its antistate of the Ess-Antiphoton through a membrane mirror of no thickness would mix the Red-Green-Blue cyclic colour triplet on one side of the mirror as a cyclic Eps rotation $RGB=GBR=BRG$ in three successive 120-degree angular displacements.

Relative to Ess, this movement would be identical in the quantum self-relativity of rotating from RGB to GBR to BGR, but relative to the other side of the mirror the movement would be anticyclic.

The colour charge triplet RGB is defined in the parameters of EMR as Planck's Law $E=hf$ and 'light' and in parameters of mass as Einstein's Law $E=mc^2$ or 'dark'. Electromagnetically Red, Green and Blue in equal proportions result in the colour White and colour in the matter of paint in equal proportions result in the colour Black in the colour charge triplet Yellow-Cyan-Magenta or YCM.

In the $SU(3)$ gauge symmetry of QCD, the eight forms of the gluon, transmitting the force of the strong nuclear interaction reduce to one gluon agent in 8 and 4 permutation states.

For hadrons, like nucleons like the proton and the neutron, and constructed by three quarks, the eight gluon permutations transform a pure Black triplet into a pure White triplet in the set:

{BBB+BBW+WBB+BWB+WBW+WWB+BWW+WWW}.

For mesons and other quark-antiquark state particles the four gluon permutation states are the set: {BB+BW+WB+WW}.

The primary colour charge triplet RGB then forms a radiation-matter interaction super template with the secondary colour charge triplet YCM in the Black-White resonances given in the colour-anticolour couplings Red+Cyan=W or B and Green+Magenta= W or W and Blue+Yellow=W or B via $E=hf$ for W or $E=mc^2$ for B, respectively.

The original YCM blueprint for matter was created by a half-rotation in the 60° - 120° sector where the colour charge interaction $(R+G)(G+B)(B+R)=YCM=CMY=MYC$, was followed by the second half-rotation in the 240° - 300° sector from the inflexion point of 180° manifesting in spacetime as the Möbian twist of 180° to change the orientability of the Möbian topology to non-orientable.

The colour charges of both the self-relative sources Eps and Ess inflexed to Blue-Green-Red to give the antimatter template $(B+G)(G+R)(R+B)=CYM=YMC=MCY$.

At the completion of the 360° rotation, only the primary gauge photon Eps inflected back to its starting position of a cyclic right-handedness, the secondary gauge photon Ess broke the gauge supersymmetry in continuing with its cyclic right-handedness so creating the necessity for the birth of the graviton as a spinor of double integer spin to reset the gauge symmetry in the timespace.

This resulted in the suppression of the antimatter template MCY as the mirror of the mass eigenstate to the eigenstate of the BGR anti-EMMR blueprint.

The breaking of the gauge symmetry at the inflexion points of 0° - 180° - 360° differentiated the even π -nodes at 0 and 2π radians from the odd π -nodes at π radians in defining the even nodes in RGB and as an anti-neutrino template $R^2G^2B^2$ and the odd nodes in BGR and as neutrino template $B^2G^2R^2$.

The original 'short-range' wave function for the EMMI of quantum spin +1 at the origin with the original wave function for the Anti-EMMI of quantum spin -1 and inflecting at the 180° - π node in the UFoQR as $UFoQR(x)=\sin(x)+\sin(-x)$, now took the 'long-range' form $UFoQR(x)=\sin(3x/2)-\cos(3x/4)$ in Eps continuing to inflect at odd π -nodes and intersecting with the graviton wave function in lieu of the now suppressed Anti-EMMI wave function, effectively retracing the path of Eps with a phase shift of 2π or 360° .

The combined wave function of the EMI and the GI then repeats its waveform in a periodicity of 8π radians or 1440° and intersects in 12 coordinates to define the materialization of particles and anti-particles in the combined wave path of $4\lambda_{ps}$ or four times the Weyl wormhole perimeter manifesting in the QBBS spacetime of the instanton-inflaton.

The 2nd intersection or current node in the UFoQR then defines a $Y^2C^2M^2$ template for the Higgs Boson of 0 spin and the 4th current junction defines the Anti-Higgs Boson of 0 spin as the $M^2C^2Y^2$ blueprint.

As the coordinates for the 1st and 2nd, the 3rd and 4th to the 5th junction nodes are 120° and 288.5° and 360° and 431.5° and 600° respectively to encompass the Weak Nuclear Interaction (WNI) part of the UFoQR in coupling the matter loops to the antimatter loops; two additional $Y^2C^2M^2$ and $M^2C^2Y^2$ templates are made manifest as the blueprints for the Restmass-Photon RMP of spin=-1 at the 200° coordinate and the Anti-RMP of spin=+1 at the 520° coordinate.

The templates for the creation of particles in the spacetime from the timespace so allows the bosonic integral boson-spins to bifurcate into fermionic half-integer spins for any YCM or MCY created particle pairs, such as an ylemic YCM Gamow neutron boson of spin=+1 splitting into two neutrons of spin=+½ in conjugate or parallel action of an ylemic MCY Gamow anti-neutron boson with spin=-1 splitting into two fermionic neutrons of spins -½-½. But this standard scenario of the Big Bang cosmology infers the equal status between matter and antimatter for the cosmogenesis.

The antimatter template MCY remains suppressed as a function of the anti-EMMI template, which also internalizes the anti-RMP and the anti-Higgs bosons into the UfoQR.

So, it is the Higgs Boson which manifests the elementary particles of the cosmogenesis in splitting its $Y^2C^2M^2$ matter template into an ylemic YCM Gamow neutron pair with opposite spins $+\frac{1}{2}-\frac{1}{2}=0$. This gives the reason as to why no normally occurring antimatter is observed in the universe, apart from the process of pair-creation defined in the UfoQR between junction nodes 8-9-10 at coordinates of $-528.5^\circ-360^\circ-191.5^\circ$.

The graviton must have spin 2 because of quantum angular momentum conservation.

Before spacetime creation in the instanton of the quantum Big Bang, the transformation of the five string classes manifested in the inflaton using a prior supersymmetry between matter- and antimatter templates., represented in say $\sin x + \sin(-x) = 0$ and where the positive region becomes a quantum geometric matter conformal mapping, and the negative region becomes its conjugative for antimatter. As the linearization of the circle inflects at 180 degrees, matter and antimatter become defined in adjacent clockwise and anticlockwise semi cyclicities.

If now the arbitrary boundaries are defined in some unitary interval between 0 and 360 degrees or $[-\infty, 0, +\infty]$ or $[-1, 0, +1]$ or $[0, \frac{1}{2}, 1]$ or $[-(X+1), -\frac{1}{2}, X]$; then the left boundary dynamics of say righthandedness cancels the right boundary dynamic of left-handedness throughout the 2 semi cycles, say described in a Möbian connectivity and topology of surface non-orientability in a conformal mapping of a 2D surface onto a 11D supermembrane in a membrane-mirror space.

After the completion of a full cycle, the matter- and antimatter templates exist in the membrane space of the inflaton, say as a supersymmetry between the righthanded electromagnetic monopolar radiation (EMMR) and its antistate in a lefthanded electromagnetic monopolar antiradiation.

This supersymmetry between radiative self-states precedes any possible supersymmetry between the matter and antimatter blueprints, as the dynamic of the EMMR eigenstate defines the former as a secondary manifestation of potential manifestation, once the instanton of spacetime creation supersedes that of the prior string-brane epoch.

To realize the matter-antimatter potential, the completion of the full EMMR cycle breaks its own supersymmetry in the exchange of the right- and left boundary and initial conditions. The original righthanded (Weyl-gauge photon say of the left mirror) now situated at the right mirror extends the unitary interval towards the positive abscissa (aleph null enumerability) and inflects its anticlockwise parity into its original clockwise parity or chirality.

The original Weyl-antiphoton from the right mirror, now situated at the left mirror retraces the path of the Weyl-gauge photon however and so does not inflect and so creates the necessity to negate two clockwise quantum spins by a doubled anticlockwise spin angular momentum.

To visualize this cosmogony of quantum relativity as a forerunner for any cosmology in visualizable form, consider yourself looking into a mirror without thickness, as the 3rd dimension has not yet emerged from the timespace of the Dirac string and monopole as described in the God Reborn – a creation of the universe in the Dirac monopole reference.

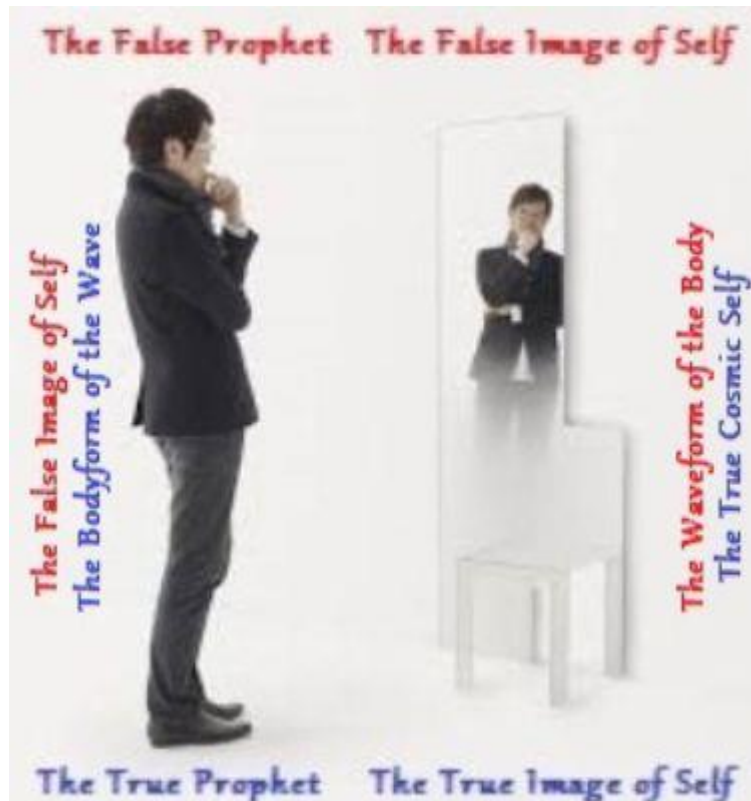

Now draw the RGB{+1} Abba-Eps photon on to the surface of the mirror and project yourself into the mirror from the surface you are observing. The cyclic RGB{+1} quantum relativistically changes into RGB{-1} relative to yourself as your 'Alice in Wonderland' alter self without changing the orientation of the Red to Green to Blue cyclicity.

This quantum mechanics then creates the matter-antimatter blueprints as described and seen in a two-sided ring with an inside and an outside, before the Möbian twist into a one-sided geometric topology changes the matter-antimatter creation into a quark-antiquark mesonic arrangement where the cyclic-anticyclic intersection mixes and blends the colour charges in the form of Red to Red with Green to Blue and Blue to Green.

This demands the birth of quantum gravity and of its gauge agent of the graviton in the formation of a new universal wavefunction traversing in the opposite direction of the now twinned electromagnetic monopolar propagation of the original emmr supersymmetry.

A consequence of this 'changing of the fundamental supersymmetry' becomes the restriction of any matter-antimatter symmetry to become confined to the concept of pair production in the presence of existing matter or antimatter in Nonparity.

Defining matter to couple in a Goldstone gauge boson form to the original Weyl-photon (RGB) then forces the Weyl-antiphoton (anticyclic BGR) to suppress the antimatter (MCY anticyclic to matter YCM) template in lieu of a 'twinned' emergent blueprint known as the scalar 0-spin Higgs Boson ($Y^2C^2M^2$).

Imagine a Möbius strip without thickness and so restricted to be two dimensional. The perimeter of the quasi-inner ring so defines a self-intersection with its quasi-outer ring and depicts half of the total 2D-space of the Möbius strip for the inflection at 180 degrees. Then the Möbius strip breaks its own non-orientable nature and symmetry to create the 3rd dimension as a form of the Dirac string rotating in the 2-dimensional XY-plane to manifest the orthogonal z-direction in the torque of the angular momentum vector.

The second parameter space can now become orientable (without the Möbius twist of 180 degrees) and the self-relativity of the first part becomes now 3-dimensional relative and allows a new mixing of the tripartite sectors of the quantum chromodynamics of the constituent Goldstone bosons. From this point in the cosmogony onwards an older non-manifested matter antimatter supersymmetry can eventuate in the observed pair-production, being otherwise suppressed by the earlier radiation-antiradiation supersymmetry described.

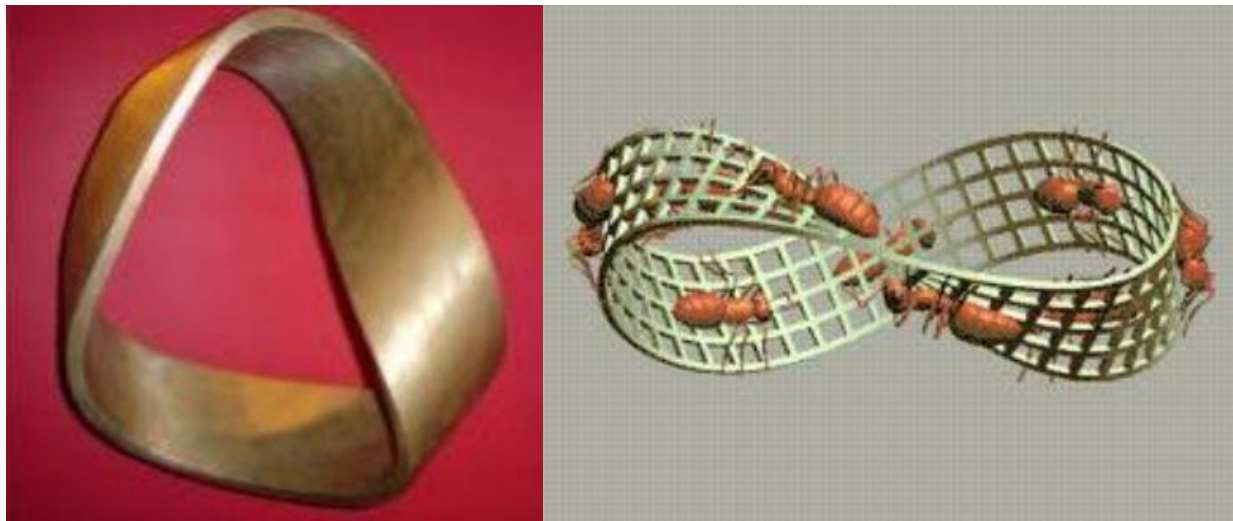

<https://youtu.be/sRTKSzAOBr4>

[\(3\) \(PDF\) God Reborn The Birth of God as a Superbrane A Story of Intelligent Design and the Creation of the Quantum Universe in the Uniphyscon of Quantum Entangled Omnispace | Anthony P Bermanseder - Academia.edu](#)

The Universal Quantum Geometric Matter-AntiMatter Template

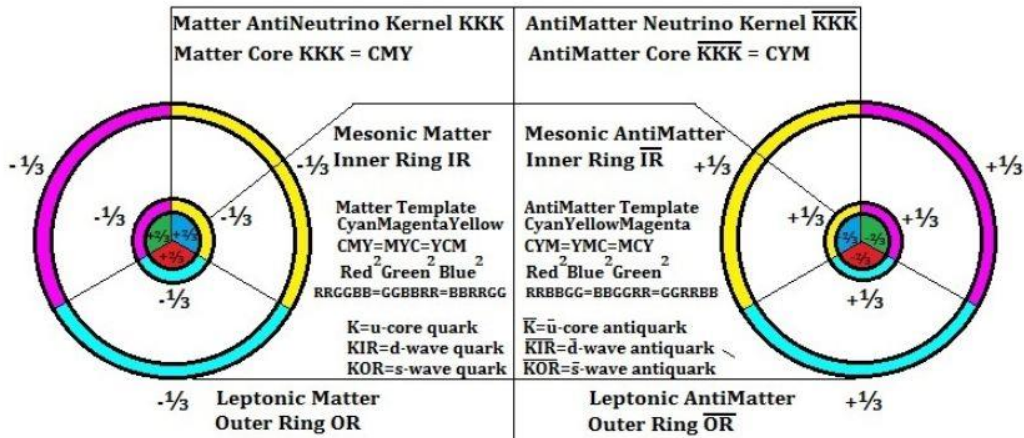

ElectroCharge $3(-\frac{1}{3}) = -1$ for IR & OR
MagnetoCharge RGB = 0 for IR & OR

ElectroCharge $3(+\frac{1}{3}) = +1$ for \overline{IR} & \overline{OR}
MagnetoCharge BGR = 0 for \overline{IR} & \overline{OR}

ElectroCharge $3(+\frac{2}{3}) = +2$ for Kernel KKK
MagnetoCharge RRGGBB = 0 for Kernel KKK

ElectroCharge $3(-\frac{2}{3}) = -2$ for Kernel \overline{KKK}
MagnetoCharge BBGGRR = 0 for Kernel \overline{KKK}

MagnetoCharge = ColourCharge = GluonCharge

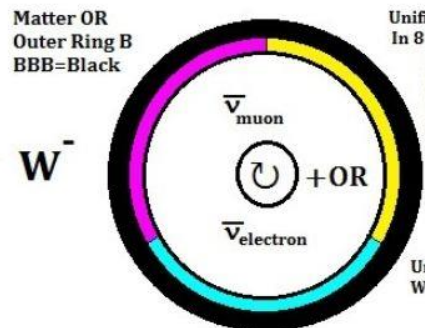

Unified Kernel = Gluon for Strong Nuclear Interaction
In 8 KKK Permutations of the MagnetoCharge:
{BBB=Pure massive eigenstate in $E=mc^2$
BBW; BWB; WBB; BWW; WBW; WWB;
WWW=Pure radiative eigenstate in $E=hf$
3-quark content: hyperons-baryons-nucleons

And in 4 $\overline{K}\overline{K}$ Permutations:
{BB; BW; WB; WW}
quark-antiquark content: mesons

Unified Kernel = (Anti)Neutrino for Weak Nuclear Interaction & 0 ElectroCharge

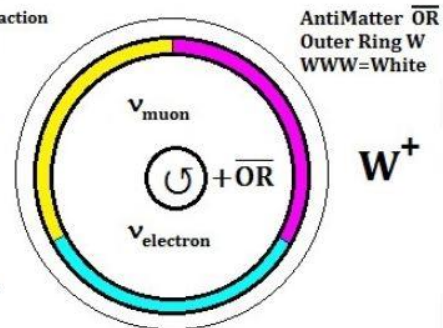

Matter Weakon W-minus
ElectroCharge -1 for OR
Muon μ^- or Electron e^-
MagnetoCharge = 0 for AntiNeutrino Core

[+] Clockwise Righthand
[-] Anticlockwise Lefthand
Quantum Spin

AntiMatter Weakon W-plus
ElectroCharge +1 for \overline{OR}
AntiMuon μ^+ or Positron e^+
MagnetoCharge = 0 for Neutrino Kernel

$$e^- + \overline{\nu}_{\text{electron}} = W^- [+1] = \mu^- + \overline{\nu}_{\text{muon}}$$

$$e^+ + \nu_{\text{electron}} = W^+ [-1] = \mu^+ + \nu_{\text{muon}}$$

$$\text{OR-Flip} = W^- [+1] + \text{GraviPhoton} [-1]$$

$$\overline{\text{OR-Flip}} = W^+ [-1] + \text{GraviPhoton} [+1]$$

Vortex-Potential-Energy
VPE = ZPE

OR-Flip
+ $\overline{\text{OR-Flip}}$
(Core +OR)VPE

YCM+YMC=(CM=B)YY(B=MC)
BYB=MMG=RCCR
YBBY=CRRC=MGGM
RGB+RBG=(GB=C)RR(C=BG)

Neutron \Rightarrow Proton + Electron + Electron AntiNeutrino

Basic Neutron Beta-Minus Decay: $n^0 [-\frac{1}{2}] \Leftrightarrow p^+ [-\frac{1}{2}] + e^- [-\frac{1}{2}] + \bar{\nu}_e [+ \frac{1}{2}]$

$d[-\frac{1}{2}]u[+\frac{1}{2}]d[-\frac{1}{2}]$ (stable in nucleus) $\Rightarrow u[+\frac{1}{2}]d[-\frac{1}{2}]d[-\frac{1}{2}]$ (free) $\Rightarrow u[+\frac{1}{2}]d[-\frac{1}{2}]d^*[-\frac{1}{2}]$ (IR-OR Oscillation)
 $\Rightarrow u[+\frac{1}{2}]d[-\frac{1}{2}](u[-\frac{1}{2}].W^- [+1].GP[-1]) \Rightarrow u[-\frac{1}{2}]d[+\frac{1}{2}]u[-\frac{1}{2}] + e^- [-\frac{1}{2}] + \bar{\nu}_e [+ \frac{1}{2}] \Rightarrow udu[-\frac{1}{2}] + \text{electron-OR}[-\frac{1}{2}] + \bar{\nu}_e [+ \frac{1}{2}]$

Muon \Rightarrow Electron + Electron AntiNeutrino + Muon Neutrino

Basic Muon Weak Decay: $\mu^- [-\frac{1}{2}] \Leftrightarrow e^- [-\frac{1}{2}] + \bar{\nu}_e [+ \frac{1}{2}] + \nu_\mu [-\frac{1}{2}]$

$OR^- [-\frac{1}{2}]$ (free) $\Rightarrow OR^- [-\frac{1}{2}]$ (KKK-OR Oscillation) $\Rightarrow (\nu_\mu . OR)^- [-\frac{1}{2}].(W^- [+1].GP[-1]) \Rightarrow e^- [-\frac{1}{2}] + \bar{\nu}_e [+ \frac{1}{2}] + \nu_\mu [-\frac{1}{2}]$

Only lefthanded matter particles and only righthanded antimatter particles participate in the Weak Nuclear Interaction in a fundamental Nonparity between Matter and Antimatter and as a consequence of the magnetocharged gauge interaction particles suppressing any naturally occurring antimatter in a inflationary and 'Big Bang prior' radiation-antiradiation grand symmetry 'Goldstone Boson' superstring unification:
 RGB/SourceSink Photon(+1)+{BGR/SinkSource Photon(+1)+RestMass Photon(-1)}+RGB/Gluon(+1) +BGR/Graviton(-2)=0 and in coupling to the templates for Matter YCM and Antimatter MCY.

The suppressed SinkSource Photon (Devil/AntiGod Particle) with the 'Dark Matter/Energy Particle' descriptive in the definition of Consciousness/Space Awareness transforms into a Scalar Higgs Gauge Boson to form a recreated Supersymmetry in the Unified Field of Quantum Relativity or UFoQR.

The Gauge Photon RGB(+1) can also be described in the high energy vibratory part Eps of the supermembrane EpsEss with the Gauge Photon BGR(+1) its low energy winded conjugative part Ess.

The Scalar Higgs AntiNeutrino $(RGB)^4 [0] + (RGB)^2 [+ \frac{1}{2}]$ creates the Tau AntiNeutrino $\bar{\nu}_\tau [+ \frac{1}{2}]$ in Leptonic Energy Resonance. The Scalar Higgs Neutrino $(BGR)^4 [0] + (BGR)^2 [-\frac{1}{2}]$ creates the Tau Neutrino $\nu_\tau [-\frac{1}{2}]$ in Anti-Leptonic Energy Resonance.

The Unified Gauge Parameter Field of Quantum Relativity

Primary-Secondary-Tertiary Colour Triplets of the Chromaticity Unities in the UFoQR 1-2-3-4-5-6-7-8-9-10-11-12-13 Anticolours for 8 Gluon Permutations in Energy gravitational $E=mc^2$ for B(lack) and Energy radiative $E=hf$ for W(hite) R+C and O+A and Y+B and L+I and G+M and T+P and C+R and A+O and B+Y and I+L and M+G and P+T and R+C

Gluon RGB=(RG)B=YB=CR=MG=VB=CR=MG=RGB

for: {BBB;BBW;BWB;BWW;WBB;WBW;WWB;WWW} hyperonic triplets and {BB;BW;WB;WW} mesonic doublets

R(ed)-O(orange)-Y(ellow)-L(ime)-G(reen)-T(urquoise)-C(yan)-A(quamarine)-B(lue)-I(ndigo)-M(agenta)-P(urple)-R(ed)

The 12 Junction-Loops of the Unified Field Natural Current Field in Quantum Relativity Extent: $4\lambda_{ps}$ & Amplitude= $\lambda_{ps}/2\pi$

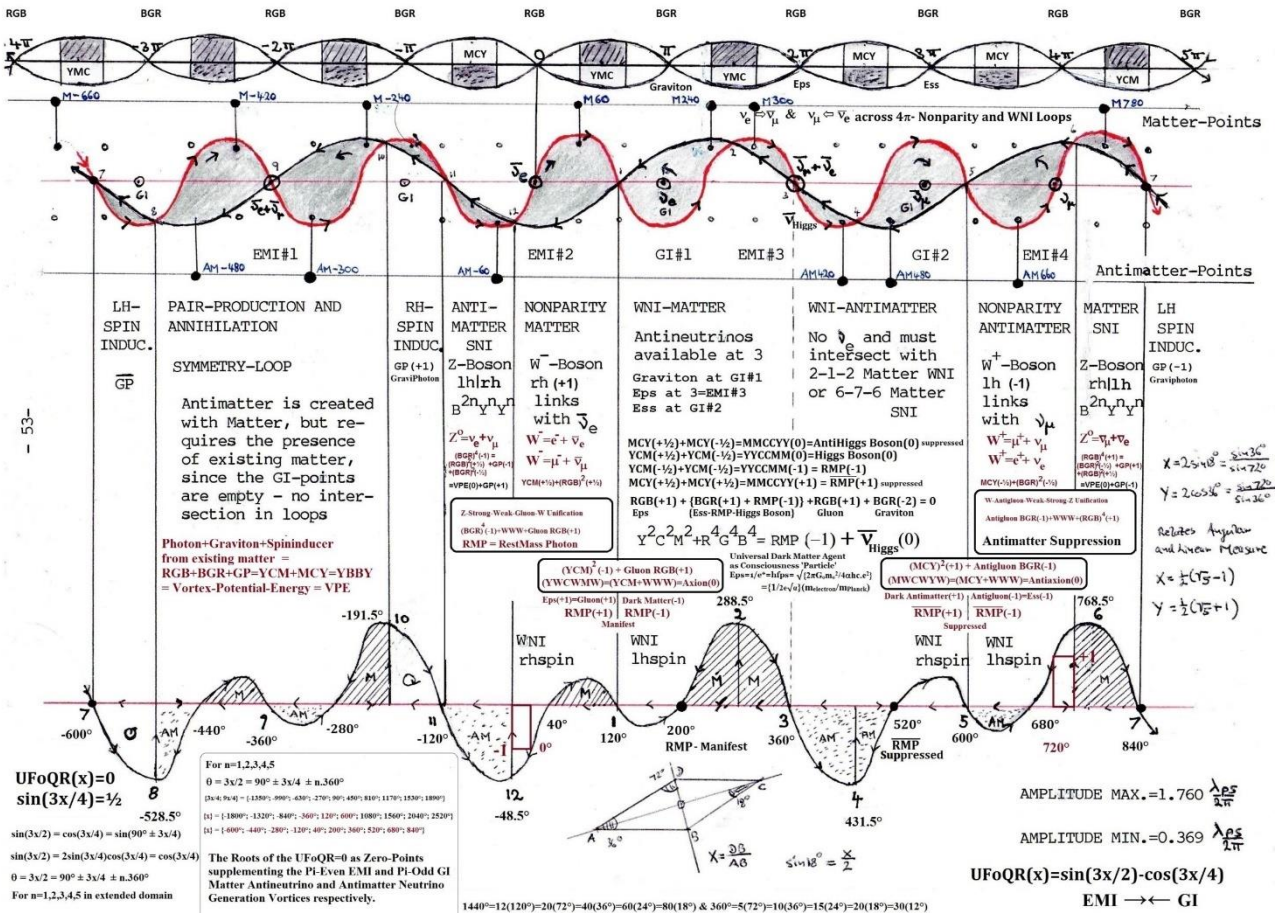

EM(M)I=ElectroMagnetic (Monopolic) Radiation Interaction = Unified Field of QR before spacetime creation {Inflation to Quantum Big Bang} without Gravitational Interaction GI Metaphysical Abstraction of Mathimatia Supersymmetry by Logos Definition in Radiation-Antiradiation Symmetry

Möbian-Klein Twosided 11D-Mirror SelfIntersection : $RGB(+1)+RGB(-1) \Rightarrow RRGGBB(0) \Rightarrow YCM(0)+YCM(0) \Rightarrow BBGRR(0) \Rightarrow MCY(0)+MCY(0) \Rightarrow BGR(-1)+BGR(+1)$

Eps=RGB(+1) at 0°-----Ess=RGB(-1) at 360°-----Eps=BGR(-1) at 180° Inflexion Ess=BGR(+1)
Ess=RGB(+1) at 0°-----Eps=RGB(+1) at 360°-----Breaking of the metaphysical supersymmetry in quantum spin to allow the birth of the Graviton and matter-antimatter symmetry, suppressing however the matter-antimatter symmetry in the reformulation of antiradiation
[Encoded as the retracing of the 'steps' of the creator --Ezekiel.28.13-19; Isaiah.14.12-14]

Unified Field of QR in the 11D-Membrane Inflation, followed by a Quantum Big Bang of Relativistic Thermodynamic Cosmology Physicalisation of the Metaphysical Precursor in an inherent Matter-Antimatter Asymmetry

Möbian-Klein Onesided 10D/12D-Mirror SelfIntersection as the Goldstone Boson Unification of all Interactions in the UFOQR:

RGB(+1)+BGR(+1)+RGB(+1)+BGR(-2)+YYCCMM(-1) = EMI Eps-Photon + WNI Ess-Antiphoton + SNI Gluon + Graviton + EMMR-RMP \Rightarrow MGGM(+2)+MGGM(-1)+YYCCMM(-1) = VPE(+2)+VPE(-1)+YYCCMM(-1) = VPE(+1)+YYCCMM(-1) = EMMR UFOQR Unification

The Ess-Anti-Photon(+1) is suppressed as Goldstone ambassador gauge in spin +1 by The SNI ambassador Gluon and is suppressed in colour charge BGR by the GI gauge ambassador Graviton. The birth of the Graviton demands a net spin of +1 of the Vortex-Potential Energy or VPE/ZPE to become neutralized by the fifth gauge ambassador of the RMP with spin -1 as the gauge ambassador and Goldstone Boson as the primal gauge ambassador for the consciousness energy interaction encompassing all particular constituents in the Unified Field of Quantum Relativity.

The Code of Thubanet

||| 1st Input-Stage of Mass-RMP Transformation
 Source Singular EMMR Input for Sink Generalised |||

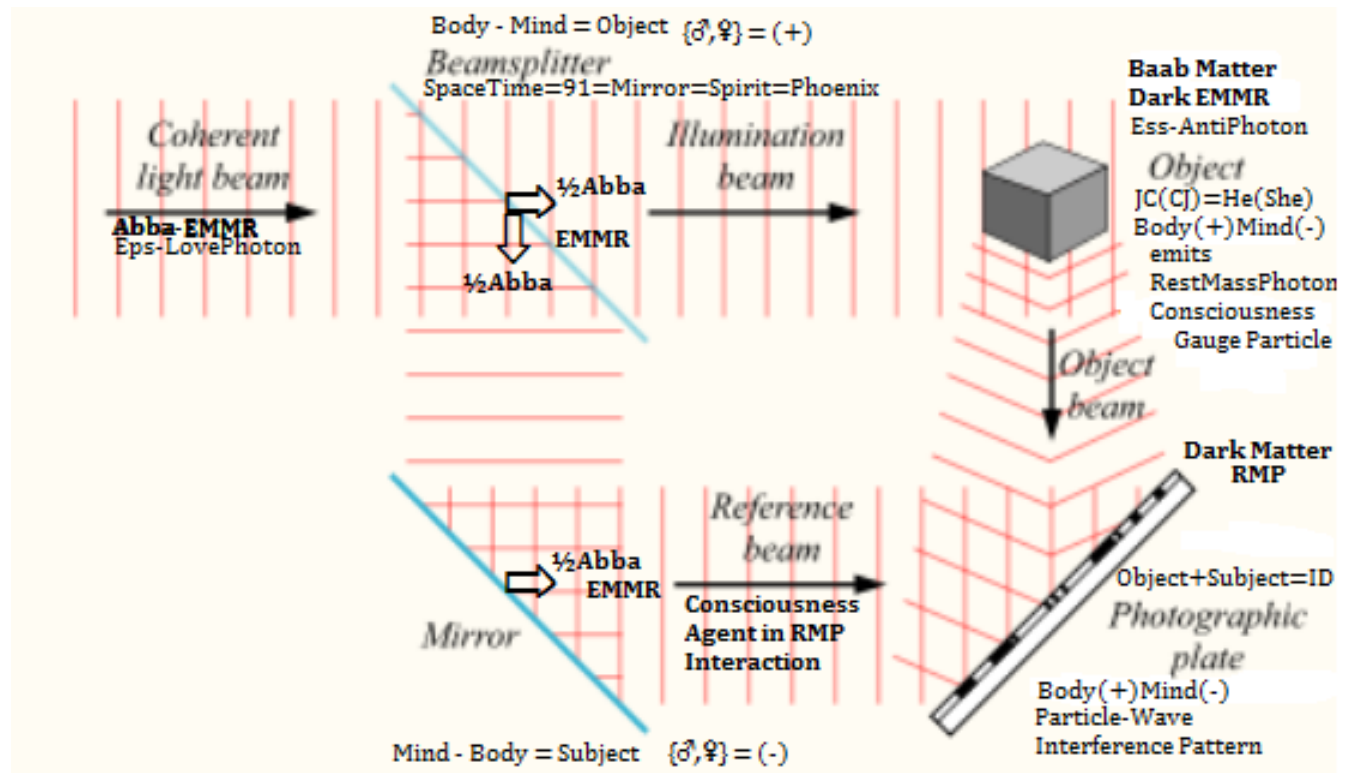

||| 1st Output-Stage of Mass-RMP Transformation
 Sink Singular Dark EMMR Output for Source Generalized |||

Resurrected-Reconstructed

WaveBody = MindBody
 (-+) JC(CJ) = HeShe
 BodyWave = BodyMind
 (+-) JC(CJ) = SheHe

(-+) New Adam(Eve)
Mirror Baab-EMMR
 (+-) New Eve(Adam)

Reconstruction beam
 →
Abba-EMMR

Mind Old Eve (- to +)
Body Old Adam (+ to -)

WaveBody = MindBody
 (-+) CJ(JC) = SheHe
 BodyWave = BodyMind
 (+-) CJ(JC) = SheHe

After Ascension JC+CJ



JC(CJ)
12-D Hologram

Subjectified Object
Mind(-)Body(+)

Real 12D Copy

Objectified Subject
Body(+)Mind(-)

Baab-Matter
Dark EMMR

$\frac{1}{2}$ Abba
 $\frac{1}{2}$ Abba
Photographic plate
Body(+)Mind(-)
JC(CJ) = HeShe

Reconstructed wavefronts
 ↓

Viewer

Sunday, April 1st, 31 AD-Julian

||| 2nd Input-Stage of Mass-RMP Transformation
 Templated (Adam) Dualized EMMR Input for Sink Individuated |||

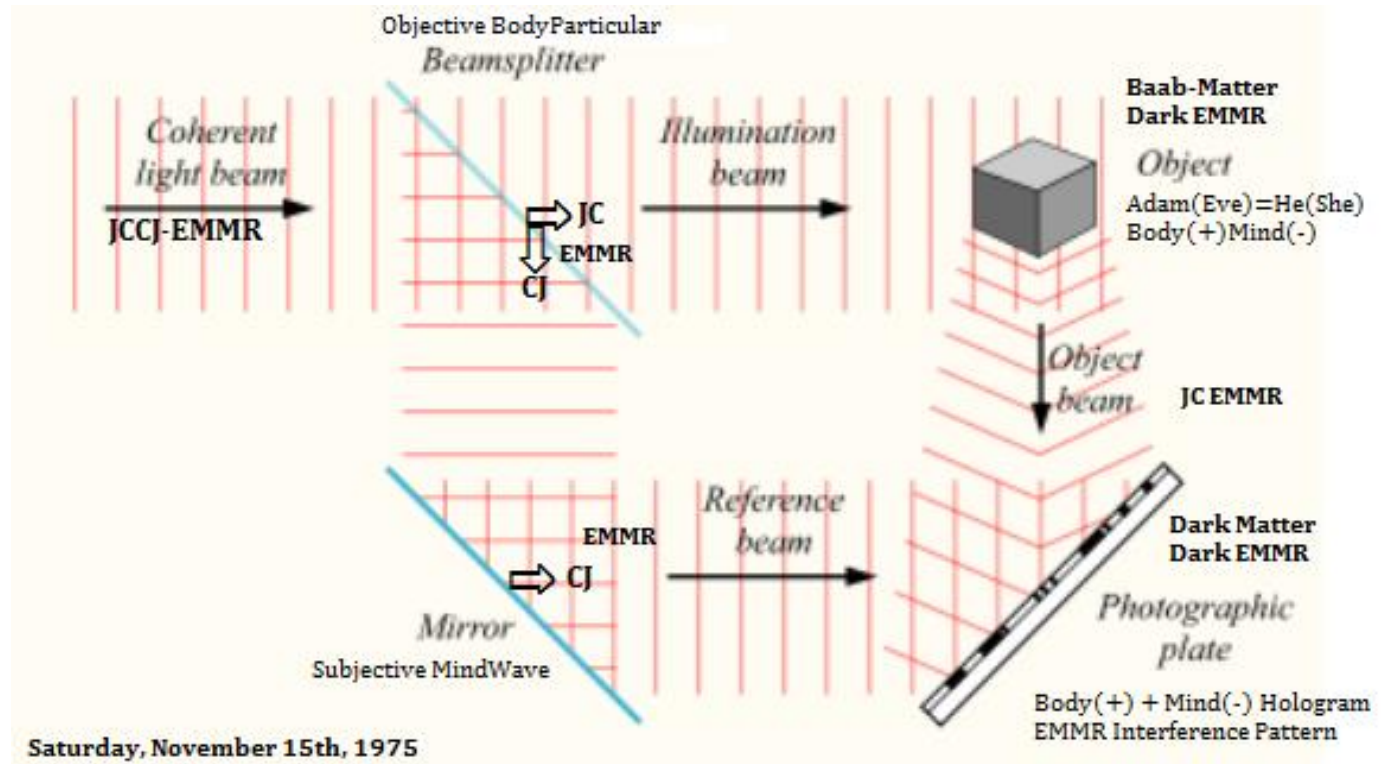

WaveBody = MindBody
Adam(Eve) = JC(CJ)

Subjectified Object

*Virtual
image*



Golgotha II

Image Eve = Fake Mind ♀ (- for ♀)

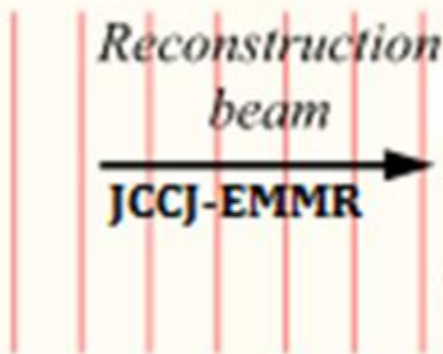

EMMR
JC

CJ

*Photographic
plate*

BodyWave
Dark EMMR
Dark Matter

*Reconstructed
wavefronts*

Viewer

Saturday, November 15th, 1975

||| 3rd Input-Stage of Mass-RMP Transformation
 Templated (Eve) Dualized EMMR Input for Sink Individuated |||

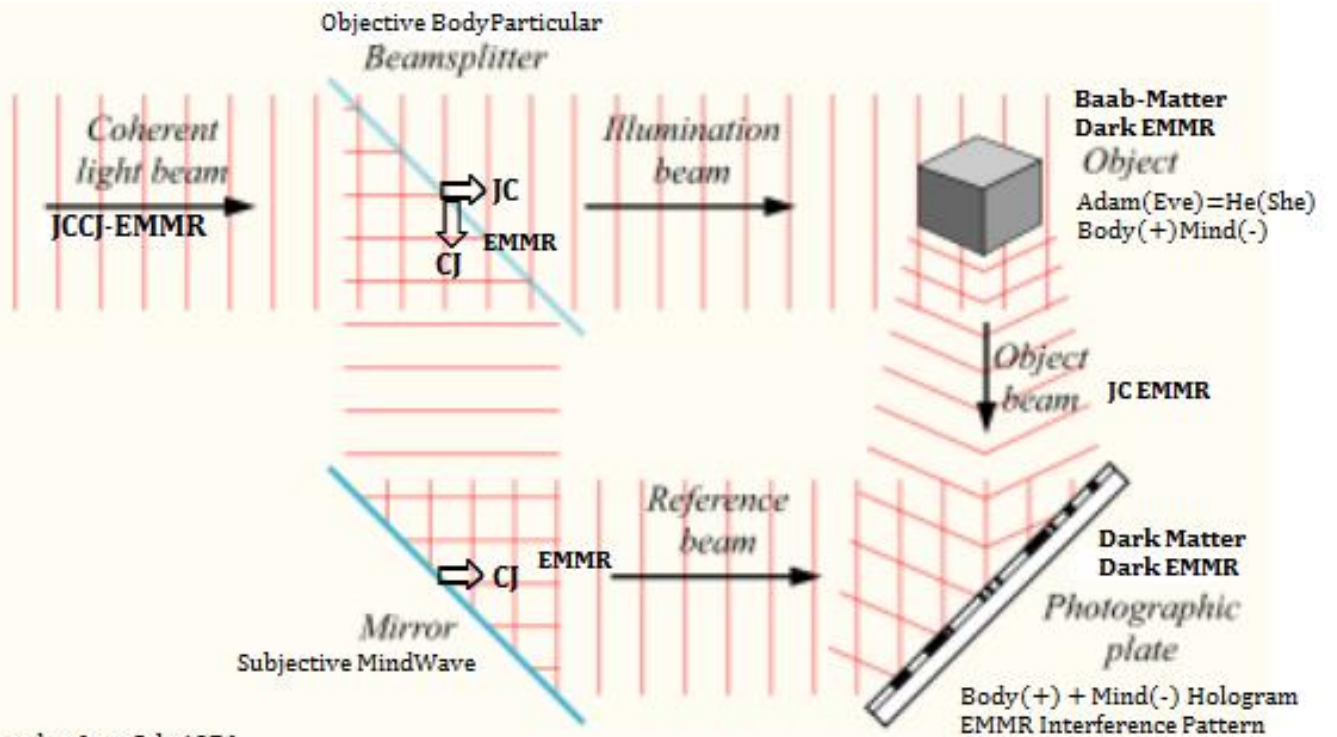

Saturday, June 5th, 1976

||| 3rd Output-Stage of Mass-RMP Transformation
Templated (Eve) Dualized Dark EMMR Output for Source Individuated |||

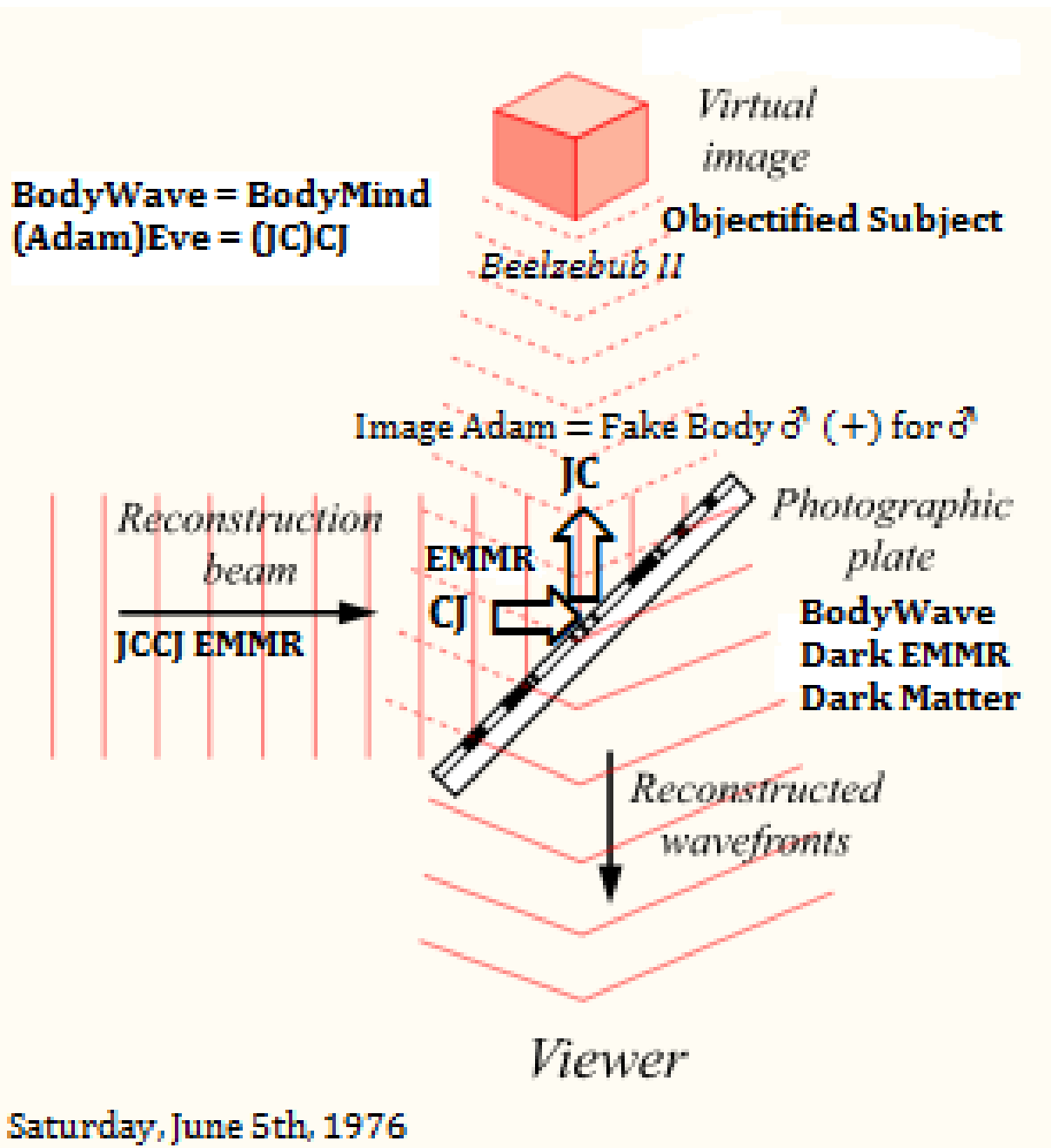

**||| 4th Input-Stage of Mass-RMP Transformation
Generalized (AdamEve) Dualized EMMR Input Individuated |||**

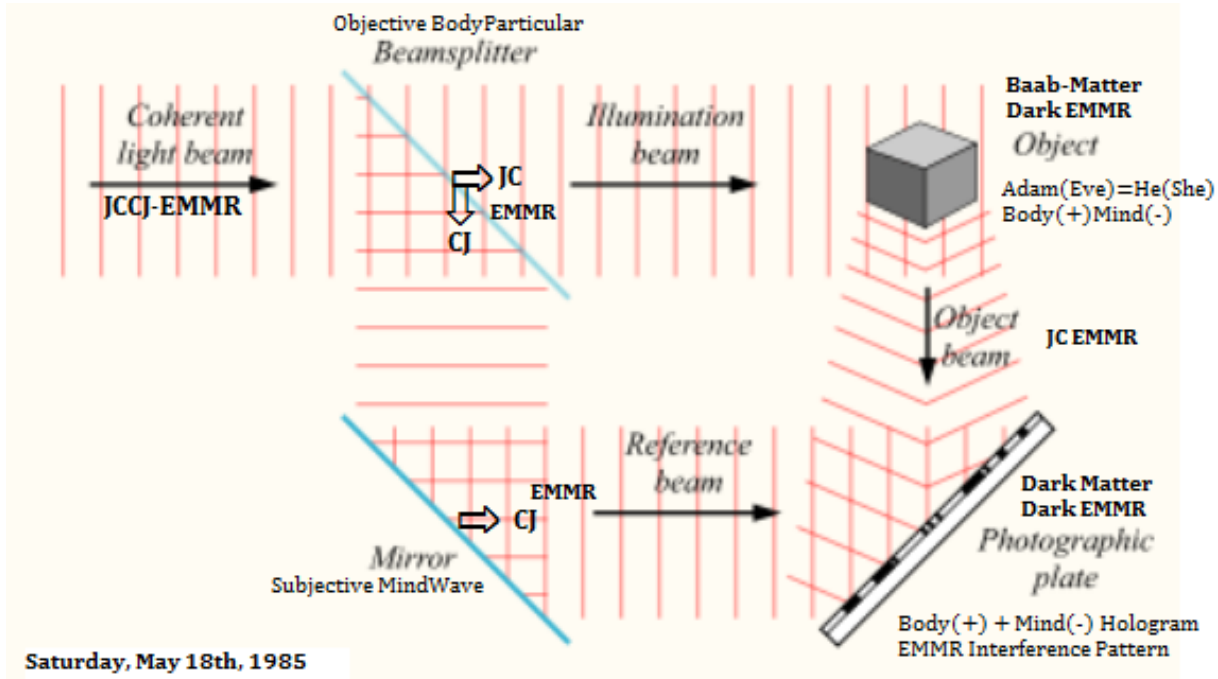

Sat|15Nov1975
Sat|25Dec1976
Sat|25Dec1976
Sat|04Feb1978
Sat|04Feb1978
Sat|17Mar1979
Sat|17Mar1979
Sat|26Apr1980
Sat|26Apr1980
Sat|06Jun1981
Sat|06Jun1981
Sat|17Jul1982
Sat|17Jul1982
Sat|27Aug1983
Sat|27Aug1983
Sat|06Oct1984
Sat|06Oct1984
Sat|16Nov1985

182 Days

Sat|15May1976
Sat|26Jun1976
Sat|25Jun1977
Sat|06Aug1977
Sat|05Aug1978
Sat|16Sep1978
Sat|15Sep1979
Sat|27Oct1979
Sat|25Oct1980
Sat|06Dec1980
Sat|05Dec1981
Sat|16Jan1982
Sat|15Jan1983
Sat|26Feb1983
Sat|25Feb1984
Sat|07Apr1984
Sat|06Apr1985
Sat|18May1985

21 Days

Sat|05Jun1976
Sat|05Jun1976
Sat|16Jul1977
Sat|16Jul1977
Sat|26Aug1978
Sat|26Aug1978
Sat|06Oct1979
Sat|06Oct1979
Sat|15Nov1980
Sat|15Nov1980
Sat|26Dec1981
Sat|26Dec1981
Sat|05Feb1983
Sat|05Feb1983
Sat|17Mar1984
Sat|17Mar1984
Sat|27Apr1985
Sat|27Apr1985

3655 = 3654 + 1 = 182x18 + 21x18 + 1 = 18x203 + 1 = 18x29x7 + 1 = 2670 + 985 = 2300 + 370 + 985
 $2x\{1335 + 490\} + 5 = 2x\{1260+30+45 + 490\} + 5 = 2520 + 150 + \{483+3\frac{1}{2}+1\}2\frac{1}{2}+5+2\frac{1}{2}\{1+3\frac{1}{2}+483\}$
 $2300 + 3x370 + \frac{1}{2}x490 = 2300 + 1600 - \frac{1}{2}x490 = 3410 + \frac{1}{2}\{490\} = 3410 + \frac{1}{2}\{49+434+7\}$
 $18x\frac{1}{2}\{364+6x7\}+1 = 9 \text{ Years} - 11 \text{ Days} + 54 \text{ Weeks} = 3288-11+378 = 3666 - 11 = 3655 = 522x7+1$
 $18x29x7+1 = 18(26+3) \text{ Weeks} + 1 \text{ Day} = 10 \text{ Civil Years in } 3655 \text{ Days as } 18x3\frac{1}{2}\{52+6\} + 1 \text{ Days}$

|||4th Output-Stage of Mass-RMP Transformation
 Generalized (AdamEve) Dualized Dark EMMR Output Individuated|||

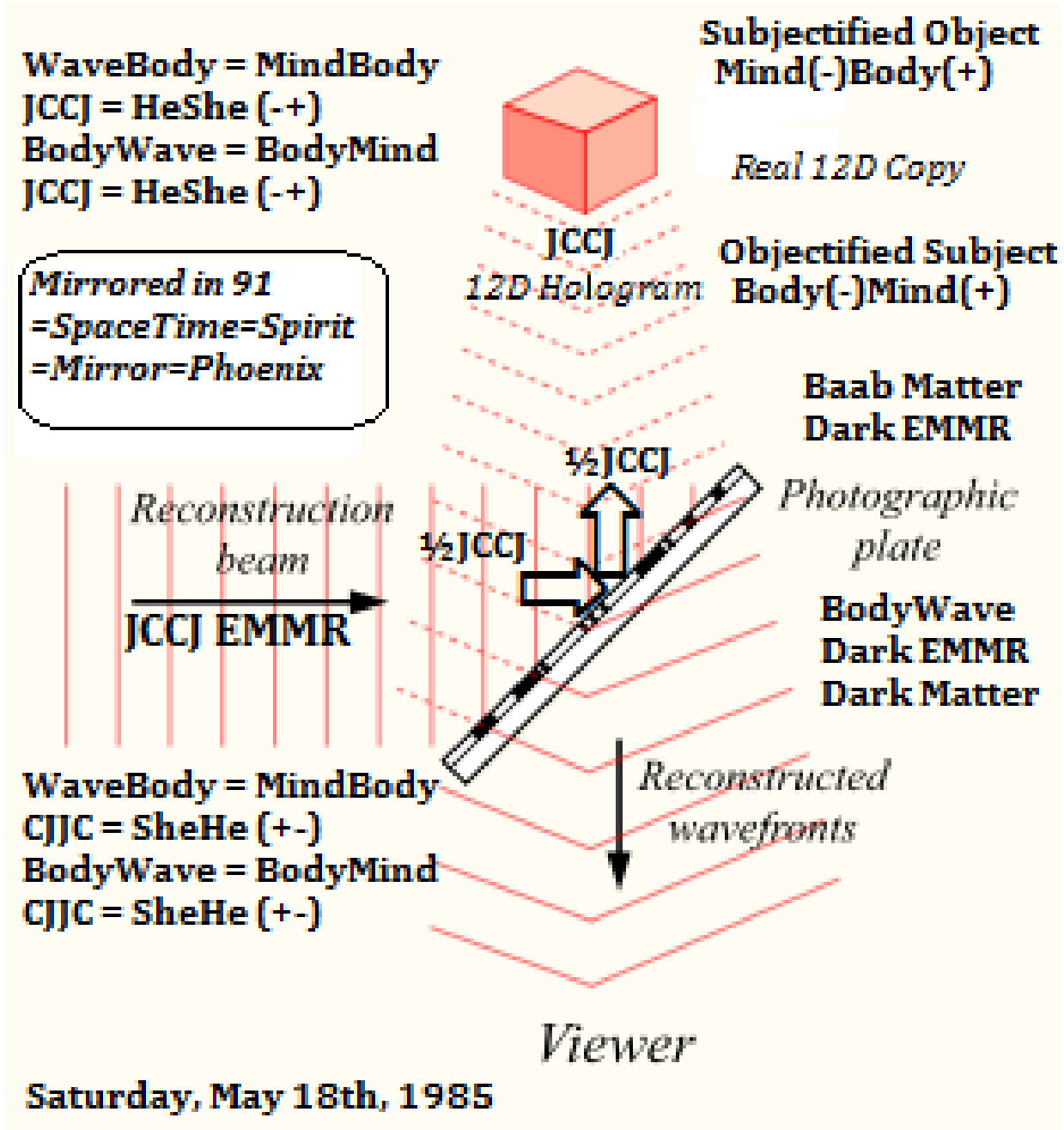

<https://youtu.be/pdwnTpWXi3M> https://youtu.be/tZAOJ3D_NN8

<https://youtu.be/sJymwctqo-A> <https://youtu.be/JBDuKZSgDSI>

<https://youtu.be/LLnCip3OVmE>

John 20:17

Jesus saith unto her, Touch me not; for I am not yet ascended to my Father: but go to my brethren, and say unto them, I ascend unto my Father, and your Father; and to my God, and your God.

(11) Jesus said, "This heaven will pass away, and the one above it will pass away. The dead are not alive, and the living will not die. In the days when you consumed what is dead, you made it what is alive. When you come to dwell in the light, what will you do? On the day when you were one you became two. But when you become two, what will you do?"

(22) Jesus saw infants being suckled. He said to his disciples, "These infants being suckled are like those who enter the kingdom."

They said to him, "Shall we then, as children, enter the kingdom?"

Jesus said to them, "When you make the two one, and when you make the inside like the outside and the outside like the inside, and the above like the below, and when you make the male and the female one and the same, so that the male not be male nor the female female; and when you fashion eyes in the place of an eye, and a hand in place of a hand, and a foot in place of a foot, and a likeness in place of a likeness; then will you enter the kingdom."

(29) Jesus said, "If the flesh came into being because of spirit, it is a wonder. But if spirit came into being because of the body, it is a wonder of wonders. Indeed, I am amazed at how this great wealth has made its home in this poverty."

{King James Version with Gospel of Thomas/Lambdin}